

Since 1969

TOLKAR[®]
SMARTEX[®]

Technological, Economical, Ecological Differences

2022 LAUNDRY

- Technological,
- Ecological,
- Economical Differences,



Hydra



miracle



miracle
hygiene



Carina
tumble dryer

Rising Stars...

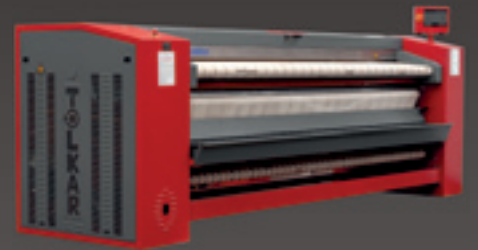
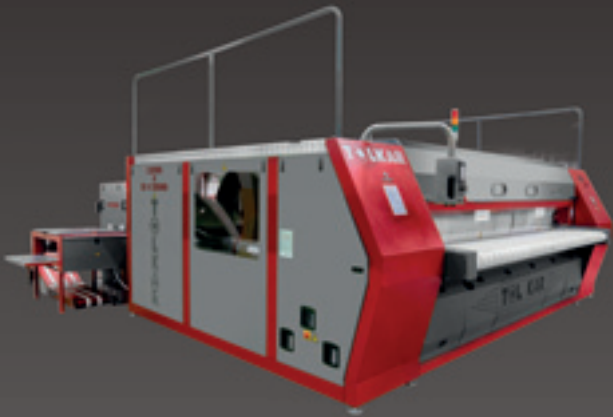



INDEX

Company Profile	6
Tolkar Future Full Automatic Loading Unloading Systems	8
Tolkar Carina Pass Through Tumble Dryers	10
Full Automatic Washer Extractors	11
Hygienic Barrier Type Washer Extractors.....	27
Tumble Dryers.....	30
Stacked Washer Extractors and Dryers Stacked Dryers	34
Speed Queen Stacked Washer Extractors / Tumble Dryers.....	35
Flatwork Ironers	36
Chest Heated Ironers	40
Linen and Towel Folding Machines	46
Feeders / Towel Rollers	50
Laundry Auxiliary Equipments.....	51
Colmac Automatic Tunnel Ironing Systems.....	53
Distributorships	54
Countries We Are Exporting To	55

WORLD'S MOST ADVANCED WASHING TECHNOLOGY

%100 MEASURABLE
SUSTAINABLE
ECONOMICAL & GREEN





COMPANY PROFILE

TOLKAR has established in 1969 as a family business regarding to produce textile processing and commercial laundry machines in city of Izmir, TURKEY. From the very first date, continuous development, better quality and customer satisfaction have made up a principle by TOLKAR where at the present day constitutes from 3 splendid innovative production factories in İZMİR Ataturk Industrial Zone, distributorship of the leader manufacturers of their sectors for supplementary products. TOLKAR has its own reputation in the world by reaching the production capacity of 3500 machines per year of various models and exports more than 91 countries abroad. Besides, 18 Regional Branches with their Sales & Service Managements in Turkey TOLKAR has more than 30 distributors with their Sales & Service Managements in abroad, ensures the fastest sales and after sales servicing facilities to their customers.

Along the stage of development, TOLKAR is devoted itself to differ as technological, ecological and economical supremacies. Utilization of latest technologies and techniques in production, TOLKAR performs from starting up the design phase, consequent research & development, prototype production, factory tests, field tests and mass production by accomplishing the mentioned triple mission. All revolutionary inventions those differs as technological, ecological and economical supremacies; have been protected with their Patents in all over the world. All our innovations offer to our customers uncompromisable and inapproachable savings where at the same time minimize the effluent in order to protect the environment for a clean world to the next generations.

TOLKAR provides all capacities of commercial & industrial laundry machines along with auxiliary equipment including turnkey projects and all textile/garment processing, washing, dyeing machines, unique waterless technologies right alongside the distributorship of the leader brands such as BIKO, COLMAC, SPEED QUEEN and RENZACCI.

In 2008, after acquisition of SMARTEX and its patented "Smart Balancing System", TOLKAR becomes the unique company who has the capability of manufacturing very high speed washer extractors by exerting 400 G force while spinning. Yet as the first and the only producer of the unique innovation introduced PolyRib ECO Drum, TOLKAR is proud to offer SMARTEX Miracle series which saves dramatically 50 % from the water, chemicals and heating energy and waste water along with the very first manufacturer of 'Direct Gas Heated' Washer Extractors.

Starting from 2013, TOLKAR announces to work on waterless and chemical free washing and processing technics by concentrating to develop Ozone Washing and Smart Flow Nano Bubble technologies for textile and garment industry in order to achieve dramatic reduction of water as well as to stop heavy chemical wastes. Today dissolution of the ozone gas within the water has achieved by TOLKAR wherein many garment processing steps can be done without chemicals and without any water discharge in shorter times. Same as Smart Flow Nano Bubble Spraying Technology achieves some steps without any water usage and without any discharge to environment.

In 2019, TOLKAR established the unmanned laundry and textile washing facilities with TOLKAR Future within the framework of Automation and Industry 4.0 applications. It has managed to establish an almost unmanned business by controlling all washing, drying, chemical transfer, recipe preparation and reporting from a single center by providing loading/unloading and textile transfers with automatic conveyors and shuttles.

With the consciousness of change alone is unchanging, TOLKAR will perpetuate the leadership in accordance with its mission to next generations.





**1000 - 1500 KG/HOUR
PRODUCTION WITH
FULL AUTOMATION
SYSTEM**

**ZERO REJECTION
WITH MAXIMUM
CLEANING
PERFORMANCE**

**SUITABLE FOR
FLEXIBLE
WORKING WITH
STAND BY SYSTEM**

**MAXIMUM
PRODUCTIVITY
WITH RAPID
LOADING &
UNLOADING**

TOLKAR FUTURE
Automatic Loading Unloading System

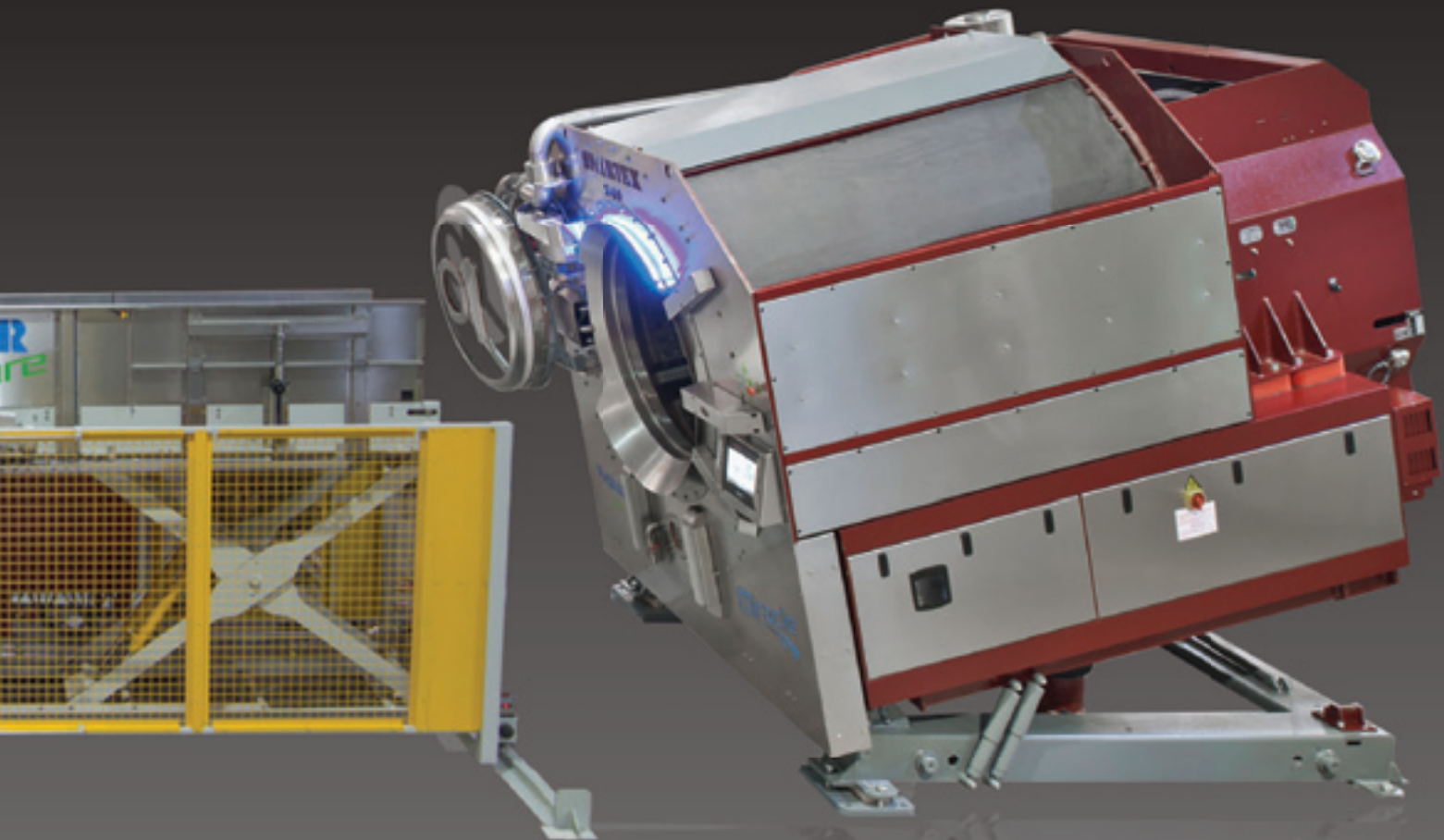

**AUTOMATIC
LOADING
UNLOADING
CONVEYOR &
SHUTTLE SYSTEM
ELIMINATES
THE NEED FOR
LABOUR 90%**

**CONTROLLED
FROM
CENTRALIZED
COMPUTER
INCLUDING
RECIPE
TRANSFER**

**FULLY MAN
FREE OPERATION
ELIMINATES
THE RISKS OF
FAILURE
AND
MISTAKES**

**MINIMUM
CHEMICAL
CONSUMPTION
WITH
AUTOMATIC
CHEMICAL
DOSING**

**ACCOMPLISHED
TRANSPORTATION
CONVEYOR
BEHIND
THE DRYERS'
FOR EASY
TRANSPORT TO
FINISHING
(OPTIONAL)**

TOLKAR CARINA PT

Pass Through Tumble Dryers

150 - 250 Kg



		3000	5000
Heating Type		Steam / Gas	Steam / Gas
Capacity	(Kg)	150	250
Drum Volume	(lt)	3.014	5.070
Drum Diameter	(mm)	1.600	1.980
Drum Depth	(mm)	1.500	1.650
Motor Power	(Kw)	5.5	5.5
Fan Motor Power	(Kw)	11	11
Steam Consumption	(Kg/Hour)	350	500
Gas Heat Power	(Kcal)	99.000	173.250
Air flow	(m³/Hour)	11.000	22.000
Width	(mm)	2.200	2.543
Depth	(mm)	2.200	3.079
Height	(mm)	4.000	4.446
Weight	(Kg)	3.000	4.9910

Steam & Gas heated models

Humidity control

Infrared control drying (Optional)



PLC controlled touch screen panel

Front side loading and back side unloading automatically

Compatible with automatic loading unloading systems

Faster drying time within 20-25 min/cycle

Tolkar reserves changing the technical specifications of the machines due to technological necessities without prior notice

SMARTEX MIRACLE
Full Automatic Washer Extractors

225 - 340 Kg



		Miracle 2250	Miracle 3430
Heating Type		Steam / Gas	Steam
Loading Capacity	(Kg/Batch)	225	340
Drum Volume	(lt)	2.280	3.398
Motor Power	(Kw)	30	18,5
Gas Heat Power	(Kcal/hour)	132.000	-
Width	(mm)	1.915 (2.580)	2.175
Depth	(mm)	2.770	2.550
Height	(mm)	2.562	2.730
Tilted Height	(mm)	2.845	3.110
Weight	(Kg)	4.530	6.670

Tank System
WATER RECOVERY
Technology

60%
WATER SAVING



BACKWARDS TILTING
EASY LOADING & UNLOADING

WATER
CONSUMPTION

Towel 1:1-1:2 L/R
Linen 1:1-1:1,5 L/R
Polyster 1:1 L/R

POLYRIB ECODRUM
SYSTEM

50% less water
chemicals
heating
energy

POLYRIB
DRUM

45%
Longer
textiles
life

400G
EXTRACTION
FORCE

TOTALLY
VIBRATION
FREE

SMARTEX MIRACLE

Full Automatic Washer Extractors

WORLD'S MOST ECONOMIC WASHING SYSTEMS



**FIRST AND THE ONLY
GAS HEATED
IN THE WORLD**

**COMPLETE
STAINLESS STEEL
BODY AND BASE
(Optional)**

WATER CONSUMPTION

Towels	1:1-1:2	L/R
Linens	1:1-1:1,5	L/R
Polyesters	1:1	L/R

POLYRIB ECODRUM SYSTEM

50% less water
chemicals
and heating energy

POLYRIB DRUM

45%
Longer
Textile Life

SMART BALANCING™

20%
Less drying
time &
drying energy

SMARTEX MIRACLE

Full Automatic Washer Extractors



400G
EXTRACTION
FORCE

TOTALLY
VIBRATION
FREE

TOLKAR ULTIMATE CONTROL SYSTEM

- Remote access, instant mobile tracking
- USB programme transfer
 - 20 ready recipes, 100 recipes
- Reporting, amount of laundry, consumption values and working hours are being reported. (Optional)
 - Smarteye centralized control and data acquisition (Optional)



PLC Controlled
7" Touch Screen Panel

10" Touch Screen Panel for 225&340 models



Automatic Liquid Detergent Dosing System

in built dosing pumps for liquid detergent dosing. Integrated with reporting and weight scale systems (Wet Clean) - (Optional)

SMARTEX MIRACLE

Full Automatic Washer Extractors



		Miracle 600	Miracle 1200
Heating Type		Elc/Stm/Gas	Steam / Gas
Loading Capacity	(Kg/Batch)	60	120
Drum Volume	(lt)	550	1.125
Motor Power	(Kw)	7,5	18,5
Gas Heat Power	(Kcal/hour)	33.000	66.000
Electric Heating Power	(Kw)	40	-
Width	(mm)	1.260	1.530
Depth	(mm)	1.890	2.415
Height	(mm)	1.765	2.030
Tilted Height	(mm)	-	2.370
Weight	(Kg)	1.290	2.230

Tolkar reserves changing the technical specifications of the machines due to technological necessities without prior notice

SMARTEX MIRACLE

Full Automatic Washer Extractors



		Miracle 1350	Miracle 1500
Heating Type		Steam / Gas	Steam / Gas
Loading Capacity	(Kg/Batch)	135	150
Drum Volume	(lt)	1.300	1.480
Motor Power	(Kw)	18,5	22
Gas Heat Power	(Kcal/hour)	66.000	66.000
Width	(mm)	1.585	1.750
Depth	(mm)	2.448	2.480
Height	(mm)	2.056	2.120
Tilted Height	(mm)	2.456	2.461
Weight	(Kg)	2.700	2.980

Tolkar reserves changing the technical specifications of the machines due to technological necessities without prior notice

SMARTEX MIRACLE

Full Automatic Washer Extractors



		Miracle 2250	Miracle 3430
Heating Type		Steam / Gas	Steam
Loading Capacity	(Kg/Batch)	225	340
Drum Volume	(lt)	2.280	3.398
Motor Power	(Kw)	30	18,5
Gas Heat Power	(Kcal/hour)	132.000	-
Width	(mm)	1.915 (2.580)	2.175
Depth	(mm)	2.770	2.550
Height	(mm)	2.562	2.730
Tilted Height	(mm)	2.845	3.110
Weight	(Kg)	4.530	6.670

DUST MATS & MOPS

- Sand separator
- Cyclone filter, self cleanable
- Laser check for tracing the mats
- Compatible with auto loading / unloading systems



BACKWARDS TILTING

Easy Loading & Unloading (optional)

Tolkar reserves changing the technical specifications of the machines due to technological necessities without prior notice

SMARTEX MIRACLE+TS

Full Automatic Washer Extractors

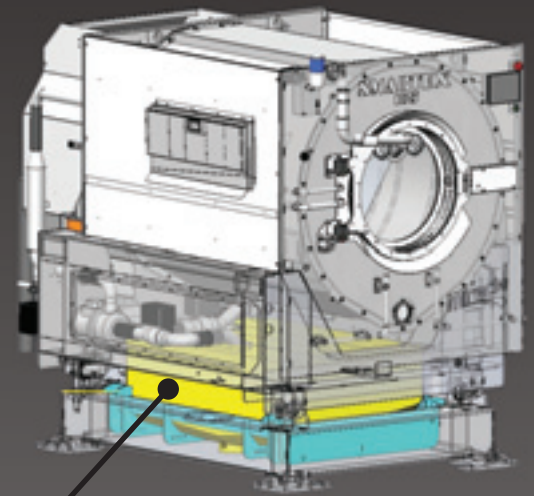

Water recovery tank

Tank System
WATER RECOVERY
Technology

60%
WATER
SAVING

		Miracle 600	Miracle 1200	Miracle 1350	Miracle 1500	Miracle 2250
Heating Type		Elc/Stm/Gas	Steam/Gas	Steam/Gas	Steam/Gas	Steam/Gas
Loading Capacity	(Kg/Batch)	60	120	135	150	225
Drum Volume	(lt)	550	1.125	1.300	1.480	2.280
Recovery Tank	(lt)	180	360	400	450	700
Motor Power	(Kw)	7,5	18,5	18,5	22	30
Gas Heat Power	(Kcal/hour)	33.000	66.000	66.000	66.000	132.000
Electric Heating Power	(Kw)	40	-	-	-	-
Width	(mm)	1.260	1.530	1.585	1.750	1.915 (2.580)
Depth	(mm)	1.890	2.415	2.448	2.480	2.770
Height	(mm)	1.765	2.030	2.056	2.120	2.562
Tilted Height	(mm)	-	2.370	2.456	2.461	2.845
Weight	(Kg)	1.290	2.230	2.700	2.980	4.530

Tolkar reserves changing the technical specifications of the machines due to technological necessities without prior notice

HYDRA Mini Midi Maxi

Full Automatic Washer Extractors



**360 G
EXTRACTION
FORCE**

**100%
HEAVY INDUSTRIAL
CONSTRUCTION**

- ST37 balance weight system
- Engineered front & rear plates and drum construction
- Enhanced new belt-pulley system and bearing housing
- Unwelded inner drum

POWERSPRAY
(Optional)

35% less rinsing
water



25% less rinsing
time

HYDRA Mini Midi Maxi

Full Automatic Washer Extractors



TOLKAR ULTIMATE CONTROL SYSTEM

-  **Remote access**, instant mobile tracking
-  **USB programme transfer**
- **20** ready recipes, **100** recipes
- (i) Reporting**, amount of laundry, consumption values and working hours are being reported. (Optional)
- **Smarteye** centralized control and data acquisition (Optional)

FULLY STAINLESS STEEL

inner & outer drums, front, sides and top covers



PLC Controlled
7" Touch Screen Panel



Automatic Liquid Detergent Dosing System

in built dosing pumps for liquid detergent dosing. Integrated with reporting and weight scale systems (Wet Clean) - (Optional)

HYDRA Mini

Full Automatic Washer Extractors

10 - 12 - 20 - 25 - 30 Kg



		Hydra Mini 10	Hydra Mini 12	Hydra Mini 20	Hydra Mini 25	Hydra Mini 30
Loading Capacity	(Kg/Batch)	10	12	20	25	30
Drum Volume	(lt)	100	120	208	254	300
Motor Power	(Kw)	1.5	2.2	3	4	4
Heating Power	(Kw)	6	8	9	12	15
Width	(mm)	825	825	990	990	990
Depth	(mm)	860	970	1.030	1.155	1.300
Height	(mm)	1.300	1.300	1.450	1.450	1.450
Weight	(Kg)	350	390	595	700	700

Tolkar reserves changing the technical specifications of the machines due to technological necessities without prior notice

HYDRA Midi

Full Automatic Washer Extractors

40 - 50 Kg



		Hydra Midi 40	Hydra Midi 50
Loading Capacity	(Kg/Batch)	40	50
Drum Volume	(lt)	400	500
Motor Power	(Kw)	5.5	7.5
Heating Power	(Kw)	18	24
Width	(mm)	1.180	1.180
Depth	(mm)	1.345	1.525
Height	(mm)	1.780	1.780
Weight	(Kg)	1.125	1.230

Tolkar reserves changing the technical specifications of the machines due to technological necessities without prior notice

HYDRA Maxi

Full Automatic Washer Extractors

60 Kg



		Hydra Maxi 60
		Steam/Elc.
Loading Capacity	(Kg/Batch)	60
Drum Volume	(lt)	586
Motor Power	(Kw)	7,5
Heating Power	(Kw)	36
Width	(mm)	1.700
Depth	(mm)	1.560
Height	(mm)	1.920
Weight	(Kg)	1.900

Tolkar reserves changing the technical specifications of the machines due to technological necessities without prior notice

Wider Loading Door

**Faster Heating with
Enhanced Steam Inlet (3/4")**

**Faster Water Intake with
Enhanced Water Inlet (1")**

Double Drain System (2")

**360 G
EXTRACTION
FORCE**



HYDRA Maxi

Full Automatic Washer Extractors

60 Kg



TOLKAR ULTIMATE CONTROL SYSTEM

-  **Remote access**, instant mobile tracking
-  **USB programme transfer**
- **20 ready recipes, 100 recipes**
- (i) Reporting**, amount of laundry, consumption values and working hours are being reported. (Optional)
- **Smarteye** centralized control and data acquisition (Optional)

Fully Stainless Steel Inner & Outer Drum

New Generation Enhanced Main Shaft and Sealing

Fully Stainless Steel Covers

PLC Controlled
7" Touch Screen Panel

New Generation Heavy Industrial Construction

New Generation Enhanced Drive System and Bearing Housing

HYDRA Maxi

Full Automatic Washer Extractors

110 Kg



Hydra
Maxi 110
Steam

Loading Capacity	(Kg/Batch)	110
Drum Volume	(lt)	1.100
Motor Power	(Kw)	15
Heating Power	(Kw)	-
Width	(mm)	1.875
Depth	(mm)	2.055
Height	(mm)	2.060
Tilted Height	(mm)	2.265
Weight	(Kg)	4.300

Wider Loading Door

**Faster Heating with
Enhanced Steam Inlet (1")**

**Faster Water Intake with
Enhanced Water Inlet (2")**

Double Drain System (4")



**FORWARD
TILTING FOR
EASY
UNLOADING**

**360 G
EXTRACTION
FORCE**

Tolkar reserves changing the technical specifications of the machines due to technological necessities without prior notice



HYDRA Maxi

Full Automatic Washer Extractors

110 Kg



TOLKAR ULTIMATE CONTROL SYSTEM

-  **Remote access**, instant mobile tracking
-  **USB** programme transfer
- **20** ready recipes, **100** recipes
- (i) Reporting**, amount of laundry, consumption values and working hours are being reported. (Optional)
- **Smarteye** centralized control and data acquisition (Optional)

Fully Stainless Steel Inner & Outer Drum

New Generation Enhanced Main Shaft and Sealing

Fully Stainless Steel Covers

PLC Controlled
7" Touch Screen Panel

New Generation Heavy Industrial Construction

New Generation Enhanced Drive System and Bearing Housing

TOLKAR MIRACLE

Full Automatic Washer Extractors

50 - 60 Kg



Green technology

PLC Controlled
7" Touch Screen Panel

WATER CONSUMPTION

Towels	1:1-1:2	L/R
Linens	1:1-1:1,5	L/R
Polyesters	1:1	L/R

POLYRIB ECODRUM SYSTEMS

50% less water chemicals and heating energy

FULLY STAINLESS STEEL

Inner & Outer Drums and Covers

FIRST AND THE ONLY GAS HEATED IN THE WORLD

		Miracle 50	Miracle 60
		Elc/Stm/Gas	Elc/Stm/Gas
Heating Type			
Loading Capacity	(Kg/Batch)	50	60
Drum Volume	(lt)	500	600
Motor Power	(Kw)	7,5	11
Gas Heat Power	(Kcal/hour)	33.000	33.000
Electric Heating Power	(Kw)	24	36
Width	(mm)	1.610	1.850
Depth	(mm)	1.525	1.590
Height	(mm)	1.780	2.130
Weight	(Kg)	1.350	2.600

* All specifications and features of Hydra Series will come along with Tolkar Miracle as standard.

Tolkar reserves changing the technical specifications of the machines due to technological necessities without prior notice



NORMA HYGIENE

Hygienic Barrier Type Washer Extractors

20 - 40 - 60 - 90 Kg

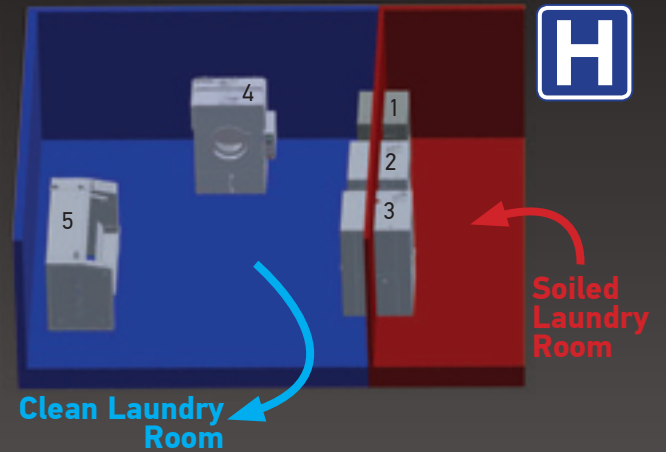

- 1- Norma Hygienic Barrier Type Washer Extractors - 20 kg
- 2- Norma Hygienic Barrier Type Washer Extractors - 40 kg
- 3- Norma Hygienic Barrier Type Washer Extractors - 60 kg
- 4- Carina Tumble Dryer
- 5- Vela Flatwork Ironer

300 G
EXTRACTION
FORCE

Green
technology

PLC
Controlled
7" Touch
Screen Panel

FULLY STAINLESS STEEL

Inner & Outer Drums, Front,
Sides and Top Covers

**100% HEAVY INDUSTRIAL
CONSTRUCTION**

**TOLKAR ULTIMATE
CONTROL SYSTEM**

- Remote access**, instant mobile tracking
- USB** programme transfer
- **20** ready recipes, **100** recipes
- Reporting**, amount of laundry, consumption values and working hours are being reported. (Optional)
- **Smarteye** centralized control and data acquisition (Optional)

		Norma Hygiene 20	Norma Hygiene 40	Norma Hygiene 60	Norma Hygiene 90
Loading Capacity	(Kg/Batch)	20	40	60	90
Drum Volume	(lt)	200	400	600	900
Motor Power	(Kw)	3	5,5	11	15
Heating Power	(Kw)	9	18	36	60
Width	(mm)	1.165	1.536	1.405	1.685
Depth	(mm)	1.035	1.225	1.450	1.450
Height	(mm)	1.565	1.775	1.995	2.060
Weight	(Kg)	785	1.190	1.600	2.200

* All specifications and features of Miracle Series will come along with SMARTEX MIRACLE HYGIENE as standard.

Tolkar reserves changing the technical specifications of the machines due to technological necessities without prior notice

SMARTEX MIRACLE HYGIENE

Hygienic Barrier Type Washer Extractors

60 Kg



		Miracle Hygiene 600	Miracle Hygiene 1350	Miracle Hygiene 2250
		Electric/Steam	Steam/Gas	Steam/Gas
Heating Type				
Loading Capacity	(Kg/Batch)	60	135	225
Drum Volume	(lt)	600	1.300	2.280
Motor Power	(Kw)	7,5	18,5	30
Electric Heat Power	(Kcal/hour)	40	-	-
Gas Heat Power	(Kcal/hour)	-	66.000	132.000
Width	(mm)	1.260	1.882	2.355
Depth	(mm)	1.890	2.475	2.770
Height	(mm)	1.765	2.206	2.522
Tilted Height	(mm)	-	2.456	2.692
Weight	(kg)	1.290	2.700	4.650

* All specifications and features of Miracle Series will come along with SMARTEX MIRACLE HYGIENE as standard.

Tolkar reserves changing the technical specifications of the machines due to technological necessities without prior notice







**FIRST AND THE ONLY
GAS HEATED
IN THE WORLD**



**PLC
Controlled**
7" Touch Screen
Panel

TOLKAR ULTIMATE CONTROL SYSTEM

-  **Remote access**, instant mobile tracking
-  **USB programme transfer**
-  **20 ready recipes, 100 recipes**
-  **Reporting**, amount of laundry, consumption values and working hours are being reported. (Optional)
-  **Smarteye** centralized control and data acquisition (Optional)

SMARTEX MIRACLE HYGIENE

Hygienic Barrier Type Washer Extractors

135 - 225 Kg

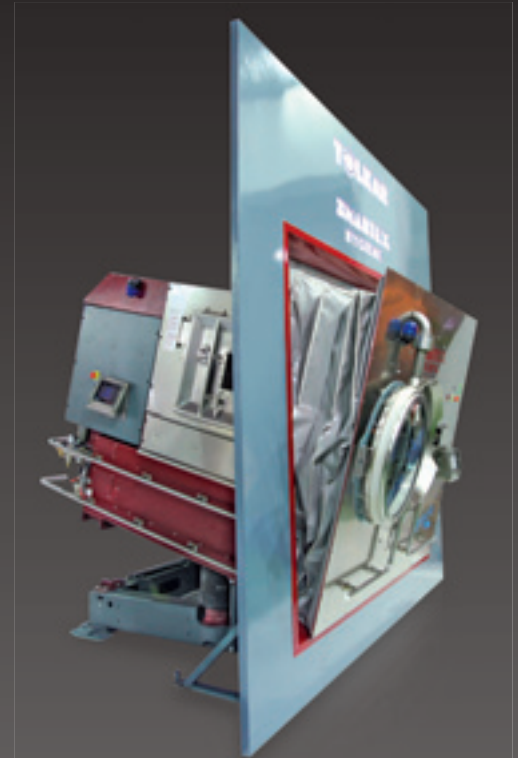

<p>400 G EXTRACTION FORCE</p>	<p>DOUBLE CONTROL PANEL</p>	<p>WATER CONSUMPTION</p> <table border="1"> <tr> <td>Greens</td> <td>1:1 - 1:2</td> <td>L/R</td> </tr> <tr> <td>Linens</td> <td>1 - 1:1,5</td> <td>L/R</td> </tr> <tr> <td>Uniforms</td> <td>1:1 - 1:1,5</td> <td>L/R</td> </tr> </table>	Greens	1:1 - 1:2	L/R	Linens	1 - 1:1,5	L/R	Uniforms	1:1 - 1:1,5	L/R	<p>OPEN POCKET SINGLE DRUM</p>	<p>FIRST AND THE ONLY FORWARD TILTING IN THE WORLD</p>
Greens	1:1 - 1:2	L/R											
Linens	1 - 1:1,5	L/R											
Uniforms	1:1 - 1:1,5	L/R											
<p>POLYRIB ECODRUM SYSTEM</p> <p>50% less water chemicals and heating energy</p>		<p>POLYRIB DRUM</p> <p>45% Longer Textile Life</p>	<p>SMART BALANCING™</p> <p>20% Less drying time & drying energy</p>	<p></p> <p>precious weight scale system</p> <p>Automatic (only required) water, steam, chemical intake according to scaled textiles (Optional)</p>									

CARINA

Tumble Dryer Machines



Green
technology

BIDIRECTIONAL
ROTATION

STAINLESS STEEL
SERPENTINES

Resist to high pressure at 10 Bar

HUMIDITY
CONTROLLED
DRYING

COOL DOWN

No more wrinkles,
hardness and thermal
shock on textiles

GAS HEATING

OPTIONAL IN
ALL MODELS



CARINA
Tumble Dryer Machines



GAS + STEAM HEATING SYSTEM
(Optional for Models 4069 - 5070)

**FULLY STAINLESS STEEL
OUTER CABINET**
(Optional)

**TOLKAR ULTIMATE
CONTROL SYSTEM**

-  **Remote access**, instant mobile tracking
-  **USB programme transfer**
- **10 ready recipes, 100 recipes**
-  **Reporting**, amount of laundry, consumption values and working hours are being reported. (Optional)
- **Smarteye** centralized control and data acquisition (Optional)



**PLC
Controlled**
7" Touch
Screen Panel



**FORWARD TILTING
FOR EASY UNLOADING**
BACKWARDS TILTING FOR EASY
LOADING - STANDART
(Models 2200-4069-5070)
(Optional for Model 1500)



**INVERTER
CONTROLLED
ADJUSTABLE
DRUM SPEED**

CARINA

Tumble Dryer Machines

201 - 305 - 405 - 500 - 605 - 805

1000 - 1200 - 1500



		Carina 201	Carina 305	Carina 405	Carina 500	Carina 605	Carina 805	Carina 1000
Heating Type		Electric	Elc./Stm./Gas	Elc./Stm./Gas	Elc./Stm./Gas	Elc./Stm./Gas	Elc./Gas	Elc./Stm./Gas
Capacity 1/20-1/15	(kg)	10/14	15/20	20/27	25/33	30/40	40/53	50/66
Drum Volume	(lt)	201	305	405	500	605	800	1.000
Drum Motor Power	(Kw)	0,37	0,75	0,75	0,75	0,75	1,1	1,1
Fan Motor Power	(Kw)	0,75	0,75	0,75	0,75	0,75/1,5/0,75	1,5	2,2/3/2,2
Electric Heating Power	(Kw)	12	14	14	24,5	21	42	63
Steam Consumption	(Kg/hour)	-	38	38	38	44	-	81
Gas Heat Power	(Kcal/hour)	-	18.000	23.000	23.000	25.000	39.600	39.600
Air flow	(m³/hour)	1.300	1.300	1.300	1.300	1.500	3.900	3.900/4.500/4.500
Width	(mm)	825	970	970	970	1.040	1.040	1.355/1.420/1.360
Depth	(mm)	915	870	1.020/1.100	1.180/1.240/1.240	1.215	1.650	1.500
Height	(mm)	955	1.650/1.780/1.790	1.650/1.780/1.790	1.650/1.780/1.790	1.780/1.860/1.910	1.860	2.130/2.250/2.380
Weight	(kg)	140	280	285	325	365	450	700

Tolkar reserves changing the technical specifications of the machines due to technological necessities without prior notice



CARINA

Tumble Dryer Machines

2200 - 2700 - 4069 - 5070

		Carina 1200	Carina 1500	Carina 1500*	Carina 2200	Carina 2700	Carina 4069	Carina 5070
Heating Type		Elc./Stm./Gas	Elc./Stm./Gas	Elc./Stm./Gas	Steam/Gas	Steam/Gas	Steam/Gas	Steam/Gas
Capacity 1/20-1/15	(kg)	60/80	75/100	75/100	110/145	135/180	200/270	250/340
Drum Volume	(lt)	1.200	1.500	1.500	2.200	2.700	4.069	5.070
Drum Motor Power	(Kw)	1,5	1,5	1,5	3	3	5,5	5,5
Fan Motor Power	(Kw)	1,5/2,2	2,2/3/3	3/3	4x1,1/2x3	4x1,1/2x3	4x3/2x3	4x3/2x3
Electric Heating Power	(Kw)	63	63	63	-	-	-	-
Steam Consumption	(Kg/hour)	95	110	110	160	270	400	500
Gas Heat Power	(Kcal/hour)	49.500	57.000	57.000	99.000	99.000	148.500	173.250
Air flow	(m ³ /hour)	4.500/6.400/6.400	4.500/6.400/6.400	6.400/6.400	6.400/6.400	11.000	22.000/11.000	22.000/11.000
Width	(mm)	1.355/1.420/1.360	1.355/1.420/1.360	1.800/1.800	2.300/2.000	2.100	2.300	2.500
Depth	(mm)	1.700	2.040	2.240	2.300	2,415	2.700	2.780
Height	(mm)	2.130/2.250/2.380	2.130/2.250/2.380	2.330/2.650	2.680/2.315	2.730/3.170	3.120/3.420	3.230/3.630
Tilted Height	(mm)		-	2.550/2.650	2.750/3.300	2.800/3.350	3.360/3.700	3.500/3.900
Weight	(kg)	725	900	1.100	1.500	2.300	3.280	3.910

* with forward tilting option. Tolkar reserves changing the technical specifications of the machines due to technological necessities without prior notice

CARINA DOUBLEDECK

Stacked Washer Dryers

HYDRA DOUBLEDECK

Stacked Washer Extractors and Dryers Stacked Dryers



10 / 10 Kg



300 G
EXTRACTION
FORCE



DIRECT GEAR
BOX DRIVE
DRYER

**100% HEAVY INDUSTRIAL
CONSTRUCTION**

**FULLY STAINLESS
STEEL**

Inner & Outer Drums, Front, Sides
and Top Covers

DOUBLEDECK WASHER			DOUBLEDECK DRYER		
Loading Capacity	(Kg/Batch)	10	Loading Capacity	(Kg/Batch)	10
Drum Volume	(lt)	100	Drum Volume	(lt)	200
Motor Power	(Kw)	1,5	Motor Power	(Kw)	0,25
Heating Power	(Kw)	6	Heating Power	(Kw)	14
Width	(mm)	825	Width	(mm)	825
Depth	(mm)	885	Depth	(mm)	915
Height	(mm)	1.225	Height	(mm)	955
Weight	(Kg)	350	Weight	(Kg)	140

Tolkar reserves changing the technical specifications of the machines due to technological necessities without prior notice

SPEED QUEEN

Full Automatic Washer and Dryers

10 / 10 Kg



WASHER

Capacity	(Kg)	10
Drum Volume	(lt)	96.8
Motor	(Kw)	0,67
Electric Heating	(Kw)	4.8
Width	(mm)	683
Depth	(mm)	704
Height	(mm)	1.027
Weight	(Kg)	122

- Stainless steel inner and outer drum
- Shorter washing time
- 6 recipes with electronic control
- Industrial components for longer life time
- 440 G - 1200 Rpm with dynamic balance

WASHER

Capacity	(Kg)	10
Drum Volume	(lt)	96.8
Max. Extraction	(G force)	440
Motor	(Kw)	0,67
Electric Heating	(Kw)	4.8

DRYER

Capacity	(Kg)	10
Drum Volume	(lt)	198
Motor	(Kw)	0,25
Electric Heating	(Kw)	5,35
Width	(mm)	683
Depth	(mm)	704
Height	(mm)	2.150
Weight	(Kg)	122

DRYER

Capacity	(Kg)	10
Drum Volume	(lt)	198
Motor	(Kw)	0,25
Electric Heating	(Kw)	5.35
Width	(mm)	683
Depth	(mm)	711
Height	(mm)	1.092
Weight	(Kg)	61

- High performance with exhaust ducting
- Shorter drying time with higher resistance power
- 5 programmes with electronic control
- Industrial components for longer life time
- Wide lint filter
- 180°C opening loading door

**COIN OR CARD
OPERATED**
(Optional)

VELA

Flatwork Ironers



**NON MARKING
WITH DOUBLE
MAIN BELT
SYSTEM**

(Optional)

**Green
technology**

GAS HEATING
OPTIONAL IN ALL
MODELS

**PADDLE BOX & FAN
SYSTEM**
FOR HUMIDITY COLLECTION
AND DISCHARGE IN
ALL MODELS

**GENUINE
NOMEX
BELTS**

**STAINLESS
STEEL
MAIN ROLL**

(Optional)

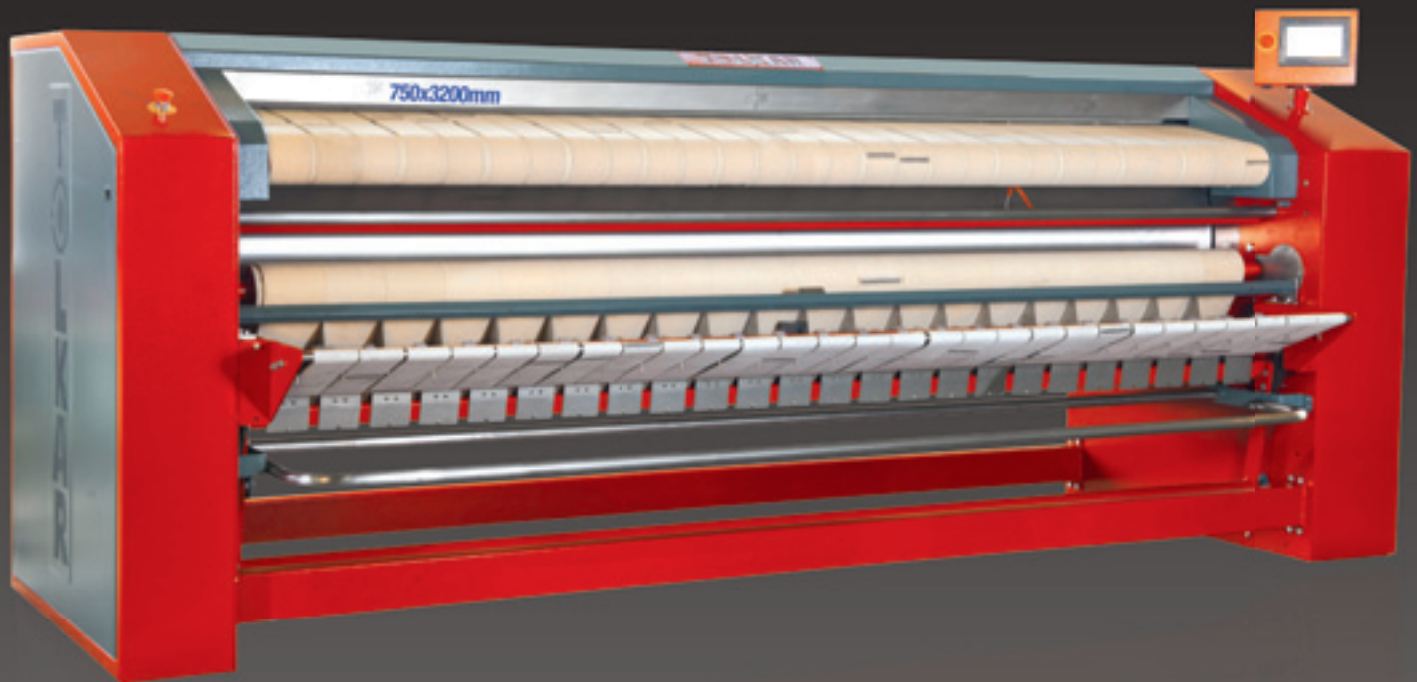

VELA
Flatwork Ironers



IN BUILT FOLDING

Vela 7532 model offers 2 - 8 primary folds between 30 - 50 cm length

TOLKAR ULTIMATE CONTROL SYSTEM

-  **Remote access**, instant mobile tracking
-  **USB programme transfer**
- **5** ready recipes, **100** recipes
-  **Reporting**, amount of laundry, consumption values and working hours are being reported. (Optional)
- **Smarteye** centralized control and data acquisition (Optional)



PLC Controlled
7" Touch Screen Panel
(Standard in Vela 7532)
(Optional)



ACCORDING TO TEXTILE TYPES
VELOCITY CONTROLLED ROLLS
(Standard in Vela 7532)
(Optional)

AUTOMATIC TEXTILE LENGTH MEASUREMENT

(Standard in Vela 7532)
(Optional)

VELA

Flatwork Ironers

320 - 500 - 550 - 650 mm
Roll Diameter



		Vela 3218	Vela 5520	Vela 5525	Vela 5530	Vela 5532
Heating Type		Electric	Elc./Steam/Gas	Elc./Steam/Gas	Elc./Steam/Gas	Elc./Steam/Gas
Cylinder Diameter	(mm)	320	550	550	550	550
Cylinder Width	(mm)	1.800	2.000	2.500	3.000	3.200
Ironing Capacity	(Kg/hour)	30-35	65-75	85-105	90-120	90-120
Working Speed	(m/min)	2-6	3,5/10,5	3,5/10,5	3,5/10,5	3/9
Motor Power	(Kw)	0,37	1,1	1,1	0,55/0,55/1,1	0,55/0,55/1,1
Fan Motor Power	(Kw)	0,37	0,37	0,37	0,37/0,37/2x0,37	0,37/0,37/2x0,37
Elec. Heating Power	(Kw)	12	22,5	27	31,5	31,5
Steam Consumption	(Kg/hour)	-	45	50	55	55
Gas Heat Power	(Kcal/hour)	-	26.350	28.900	31.570	31.570
Width	(mm)	2.530	2.730/2.730/2.890	3.230/3.390/3.390	3.730/3.890/3.890	3.930/4.090/4.090
Depth	(mm)	905	1.150/1.200/1.200	1.150/1.200/1.200	1.150/1.200/1.200	1.150/1.200/1.200
Height	(mm)	990	1.355/1.355/1.675	1.355/1.355/1.675	1.355/1.355/1.675	1.355/1.355/1.675
Weight	(Kg)	500	930	1.050	1.170	1.360

Tolkar reserves changing the technical specifications of the machines due to technological necessities without prior notice

Capacities are given for the laundry extracted at 300 G force.

It is recommended that textiles keeping more water and moisture due to thickness or knit raw material should be pre dried in the dryers before ironing.

750 - 950 - 1200 mm
Roll Diameter



		Vela 7520	Vela 7525	Vela 7530	Vela 7532	Vela 9530	Vela 12030
Heating Type		Elc./Steam/Gas	Elc./Steam/Gas	Elc./Steam/Gas	Elc./Steam/Gas	Elc./Steam/Gas	Elc./Steam/Gas
Cylinder Diameter	(mm)	750	750	750	750	950	1.200
Cylinder Width	(mm)	2.000	2.500	3.000	3.200	3.000	3.000
Ironing Capacity	(Kg/hour)	80-100	90-120	110-140	100-130	150-180	190-220
Working Speed	(m/min)	4,5/13,5	4,5/13,5	4,5/13,5	3/9	6-18	7-22
Motor Power	(Kw)	1,1	1,1	1,1	1,1	2,2/2,2/2x1,5	2,2/2,2/2x1,5
Fan Motor Power	(Kw)	0,37/0,37/0,37	0,37/0,37/0,37	0,37/0,37/2x0,37	0,37/0,37/0,75	3/3/0,37+3	3/3/0,37+3
Elec. Heating Power	(Kw)	30	37,5	42	48	72	84
Steam Consumption	(Kg/hour)	65	70	75	80	100	150
Gas Heat Power	(Kcal/hour)	26.350	31.570	35.100	41.250	66.000	82.500
Width	(mm)	2.835/2.995/2.995	3.335/3.425/3.425	3.700/3.870/3.950	4.150	4.070/4.070/4.150	4.210
Depth	(mm)	1.400/1.450/1.540	1.400/1.450/1.540	1.760 (2.337)	1.480	2.020 (2.800)	2.100 (2.870)
Height	(mm)	1.850/1.800/2.170	1.850/1.850/2.170	1.850	1.630	2.355	2.353
Weight	(Kg)	1.475	1.600	1.725	1.920	2.525/2.525/2.325	3.990/3.640

Tolkar reserves changing the technical specifications of the machines due to technological necessities without prior notice

Capacities are given for the laundry extracted at 300 G force.

It is recommended that textiles keeping more water and moisture due to thickness or knit raw material should be pre dried in the dryers before ironing.



VELA CHI

Chest Heated Ironers





GAS HEATING
OPTION IN ALL MODELS

**HUMIDITY
DISCHARGE
VIA INVERTER
CONTROLLED FANS
FROM INSIDE
THE ROLLS**



 SINGLE
 DOUBLE
ROLLS

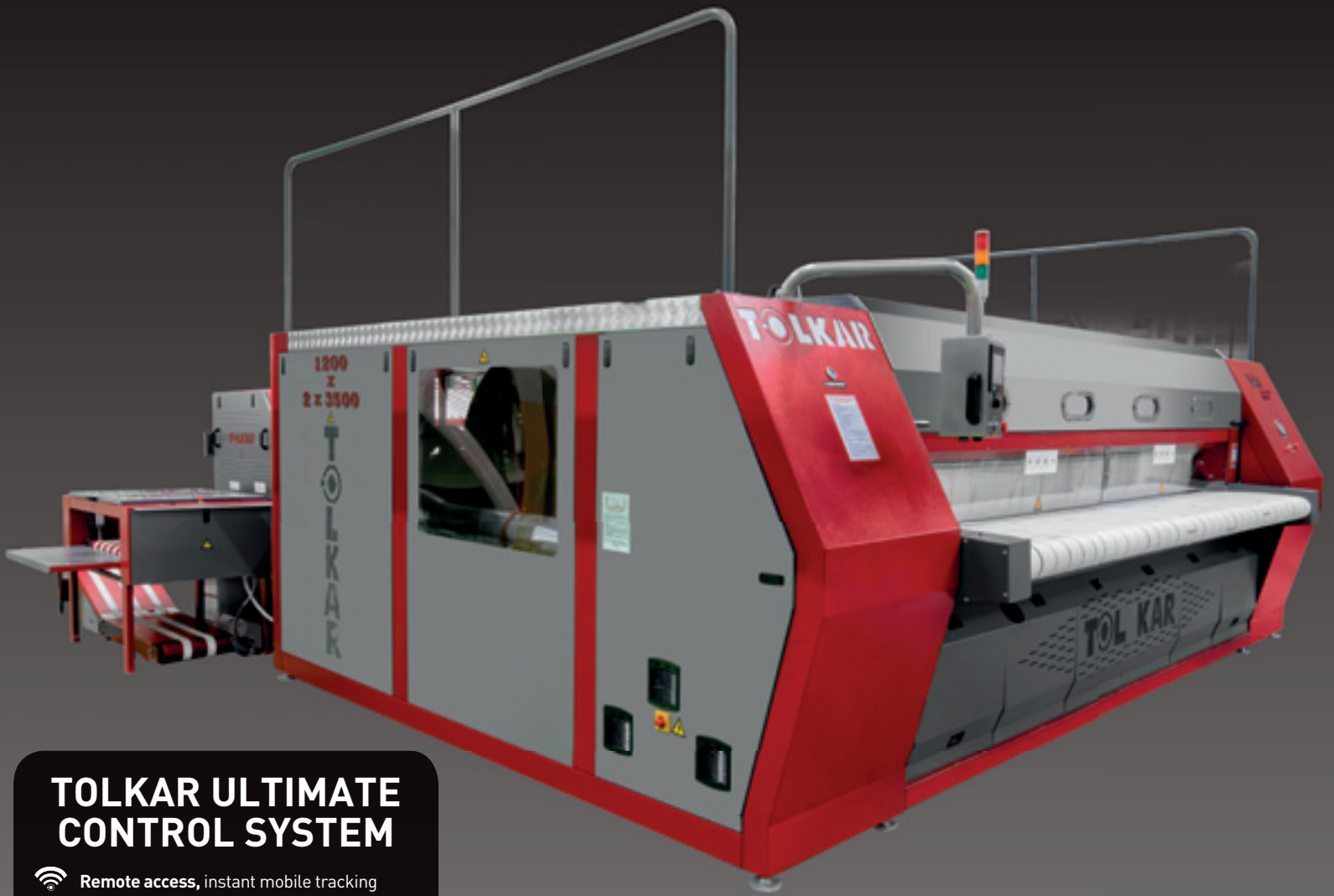

**DIRECT DRIVE
WITH
GEAR BOX**

VELA CHI
Chest Heated Ironers



TOLKAR ULTIMATE CONTROL SYSTEM

-  **Remote access**, instant mobile tracking
-  **USB programme transfer**
 - **5** ready recipes, **100** recipes
-  **Reporting**, amount of laundry, consumption values and working hours are being reported. (Optional)
- **Smarteye** centralized control and data acquisition (Optional)

PLC Controlled
7" Touch Screen Panel

ACCORDING TO TEXTILE TYPES
VELOCITY CONTROLLED ROLLS

HIGH PRESSURE RESIST (12 BAR)
GERMAN MADE CHESTS

MAXIMUM PRESSURE & PRESSING
Quality via special spring crushes and pneumatic systems

VELA CHI

Chest Heated Ironers

800 - 1200 mm
Roll Diameter



		Vela CHI 18030	Vela CHI 28030	Vela CHI 18033	Vela CHI 28033	Vela CHI 18035	Vela CHI 28035
Heating Type		Steam/Gas	Steam/Gas	Steam/Gas	Steam/Gas	Steam/Gas	Steam/Gas
Number of Cylinder	(Pcs.)	1	2	1	2	1	2
Cylinder Diameter	(mm)	800	800	800	800	800	800
Cylinder Width	(mm)	3.000	3.000	3.300	3.300	3.500	3.500
Ironing Capacity	(Kg/hour)	150	350	160	400	180	420
Ironing Capacity	(Pcs./hour)	250	600	275	650	300	700
Working Speed	(m/min)	3-12	6-21	3-12	6-21	3-12	6-21
Motor Power	(Kw)	3	2x3	3	2x3	3	2x3
Fan Motor Power	(Kw)	0,75	1,1	7,5	1,1	7,5	1,1
Gas Heat Power	(Kcal/hour)	66.825	123.750	66.825	123.750	66.825	123.750
Steam Consumption	(Kg/hour)	120	220	130	240	130	240
Width	(mm)	4.335/4.560	4.335/4.560	4.635/4.860	4.635/4.860	4.855/5.080	4.855/5.080
Depth	(mm)	1.700	3.330/3.870	1.700	3.870	1.700	3.870
Height	(mm)	2.400	2.400	2.400	2.400	2.400	2.400
Weight	(Kg)	3.700	5.800	3.750	5900	3.850	6000

Tolkar reserves changing the technical specifications of the machines due to technological necessities without prior notice. It is recommended that textiles keeping more water and moisture due to thickness or knit raw material should be pre dried in the dryers before ironing.

VELA CHI

Chest Heated Ironers

3000 - 3300 - 3500 mm
Roll Width



Gas Heating System

Chest and Drive System

		Vela CHI 112030	Vela CHI 212030	Vela CHI 112033	Vela CHI 212033	Vela CHI 112035	Vela CHI 212035
Heating Type		Steam/Gas	Steam/Gas	Steam/Gas	Steam/Gas	Steam/Gas	Steam/Gas
Number of Cylinder	(Pcs.)	1	2	1	2	1	2
Cylinder Diameter	(mm)	1.200	1.200	1.200	1.200	1.200	1.200
Cylinder Width	(mm)	3.000	3.000	3.300	3.300	3.500	3.500
Ironing Capacity	(Kg/hour)	250	600	280	660	300	700
Ironing Capacity	(Pcs./hour)	400	1000	450	1100	500	1150
Working Speed	(m/min)	4-18	9-38	4-18	9-38	4-18	9-38
Motor Power	(Kw)	7,5	2x7,5	7,5	2x7,5	7,5	2x7,5
Fan Motor Power	(Kw)	1,5	2,2	2,2	2,2	2,2	2,2
Gas Heat Power	(Kcal/hour)	106.425	200.475	125.400	247.500	125.400	247.500
Steam Consumption	(Kg/hour)	190	360	225	440	225	440
Width	(mm)	4.839/5.059	4.839/5.059	5.150/5.369	5.150/5.369	5.339/5.559	5.339/5.559
Depth	(mm)	2.171/3.253	4.050/4.476	2.171/3.253	4.050/4.476	2.171/3.253	4.050/4.476
Height	(mm)	2.742	2.742	2.742	2.742	2.742	2.742
Weight	(Kg)	4.400	9.200	4.500	9.500	4.600	9.900

Tolkar reserves changing the technical specifications of the machines due to technological necessities without prior notice
It is recommended that textiles keeping more water and moisture due to thickness or knit raw material should be pre dried in the dryers before ironing.

CAMILA MEGGY

Chest Heated Ironers



**Small Piece
Automatic Collection
and Stacking System
(Optional)**

**Conveyor
and
Stacker**

**Photocell Aided
Sensitive Textiles
Measurement**

**Automatic Speed
Synchronization
In Between Ironing
and Folding**

**Height
Adjustable
and Vacuumed
Feeding
Conveyor**



**3 Primary and
3 Cross Folds**

**DOUBLE
LANE
FOLDING**



GAS HEATED



**PLC
Controlled
10 inch Touch
Screen Panel**

MEGGY
Chest Heated Ironers



**Maximum Ironing Quality
with Double Sided Contact
In Between The Chests
and Textiles**

**Engineered Pass System
In Between Chests Without
Stripes & Ribbons**

**Engineered Convex Type
Chest System**

		Camila Meggy
Heating Type		Gas
Number Of Chests	(Pcs.)	2
Chest Diameter	(mm)	800
Ironing Width	(mm)	3.500
Ironing Capacity	(Kg/hr)	200-250
Ironing Capacity	(Pcs/hr)	350-400
Ironing Speed	(m/min)	4-18
Motor Power	(Kw)	9,34
Fan Power	(Kw)	2 x 1,5
Gas Heating Power	(Kcal/hr)	99.000
Width	(mm)	6.110
Depth	(mm)	4.160
Height	(mm)	2.900
Weight	(Kg)	9.350

**Minimum Maintenance
With Ribbon Free & Crush
Springs Free Engineered
Design**

**Air Regulator and
Automatic Air Discharge
System**

VIRGO

Linen Folding

3000 - 3300 - 3500 mm
Width



TOLKAR ULTIMATE CONTROL SYSTEM

- Remote access, instant mobile tracking
- USB programme transfer
- 100 recipes
- Reporting**, amount of laundry, consumption values and working hours are being reported. (Optional)
- **SmarteYE** centralized control and data acquisition (Optional)

AUTOMATIC SPEED SYNCHRONIZATION WITH IRONER

AUTOMATIC STACKER AND CONVEYOR

for easy handling
double stacker & conveyor
(Optional)

Single lane 2 primary 3 cross folds



Double lane 2 primary
2 cross folds and stacking
(linen, f&b) (Optional)

4 lanes, 2 primary folds
(f&b) (Optional)

Blanket and duvet folding
(Optional)



**PLC
Controlled
7" Touch
Screen Panel**

		VIRGO 3000	VIRGO 3300	VIRGO 3500
Folding Capacity	(Pcs/hour)	1.800	1.800	1.800
Working Speed	(m/min)	12-60 adjustable		
Folding Dimensions	(cm)	40x40 - 300x350		
Motor Power (Total)	(Kw)	3	3	3
Primary/Cross Folding		2 primary/3 cross		
Width	(mm)	4.705	5.005	5.205
Depth	(mm)	3.155	3.155	3.155
Height	(mm)	1.780	1.780	1.780
Weight (Conveyor included)	(Kg)	1.750	2.050	2.200

Tolkar reserves changing the technical specifications of the machines due to technological necessities without prior notice



 **PLC Controlled**
7" Touch Screen Panel



4 SPLIT INPUT CONVEYOR

ABILITY TO FOLD AND SPLIT ALL TOWEL GROUPS AUTOMATICALLY

Ability to fold
120x200 cm

 **FOLDING WITH AIR BLAST**

TOLKAR ULTIMATE CONTROL SYSTEM

-  **Remote access**, instant mobile tracking
-  **USB programme transfer**
- **100 recipes**
- (i) Reporting**, amount of laundry, consumption values and working hours are being reported. (Optional)
- **SmarteYE** centralized control and data acquisition (Optional)

HEIGHT ADJUSTABLE INPUT CONVEYOR AND DOUBLE OUTPUT FLAP

Folding Capacity	(Pcs/hour)	800 - 1.250
Working Speed	(m/min)	64
Folding Dimensions	(cm)	40x40 - 120x200
Motor Power (Total)	(Kw)	2
Primary/Cross Folding		2 primary/2 cross
Width	(mm)	2.370
Depth	(mm)	3.554
Height	(mm)	1.360
Weight (Conveyor included)	(Kg)	1.485

Tolkar reserves changing the technical specifications of the machines due to technological necessities without prior notice

VIRGO SMARTFOLD

Towel Folding



Ergonomic Stacking To Top Side Of The Machine

120x200 cm
Folding



PLC Controlled
7 inch Touch Screen Panel

ABILITY TO FOLD AND SPLIT ALL TOWEL GROUPS AUTOMATICALLY

3 Split Input Conveyor

Enhanced Flat Primary Folding System With Blades

Engineered Cross Folds Via Pistons or Air Blast Depending On The Textile Thickness

Engineered Cross Fold Transportation System By Automatic Customizable Textile Thickness

TOLKAR ULTIMATE CONTROL SYSTEM

- **Remote access**, instant mobile tracking
- **USB programme transfer**
- **100 recipes**
- **Reporting**, amount of laundry, consumption values and working hours are being reported. (Optional)
- **SmarteYE** centralized control and data acquisition (Optional)

Folding Capacity	(Pcs./hour)	900 - 1.000
Working Speed	(m/min)	54
Folding Dimensions	(cm)	40x40 - 120x200
Motor Power (Total)	(Kw)	2,75
Primary/Cross Folding		2 / 2
Width	(mm)	1.815
Depth	(mm)	3.565
Height	(mm)	1.775
Weight	(kg)	1.400

Tolkar reserves changing the technical specifications of the machines due to technological necessities without prior notice

VIRGO MAXX

Towel Folding





**PLC
Controlled
7" Touch Screen
Panel**

**ABILITY TO
FOLD AND SPLIT
ALL TOWEL GROUPS
AUTOMATICALLY**

**1 SPLIT INPUT
CONVEYOR**

with ability to fold up to
120x240 cm

TOLKAR ULTIMATE CONTROL SYSTEM

-  **Remote access**, instant mobile tracking
-  **USB programme transfer**
- **100 recipes**
-  **Reporting**, amount of laundry, consumption values and working hours are being reported. (Optional)
- **Smarteye** centralized control and data acquisition (Optional)

Folding Capacity	(Pcs./hour)	700 - 900
Working Speed	(m/min)	30
Folding Dimensions	(cm)	40x40 - 120x240
Motor Power (Total)	(Kw)	0,61
Primary/Cross Folding		1 / 2
Width	(mm)	1.550
Depth	(mm)	3.940
Height	(mm)	1.450
Weight	(kg)	1.505

Tolkar reserves changing the technical specifications of the machines due to technological necessities without prior notice

VIRGO

Napkin, Pillow Case Stacker

- Flat stacking ability for small pieces such as napkins, runners, pillow cases on 4 separate lines
- Requested number of stacked textiles are collected by only
- 1 operator instead of 4
- PLC based 7" touch screen panel
- 30 meters/min working speed
- Maximum stacking dimensions 3000-3300-3500 width options
- 100 programmes
- Separate programming for each 4 lanes
- Reporting based on textile types and numbers
- Reporting based on programme and lanes
- Automatic speed synchronization with chest heated ironers and folding machines
- By pass option for large items

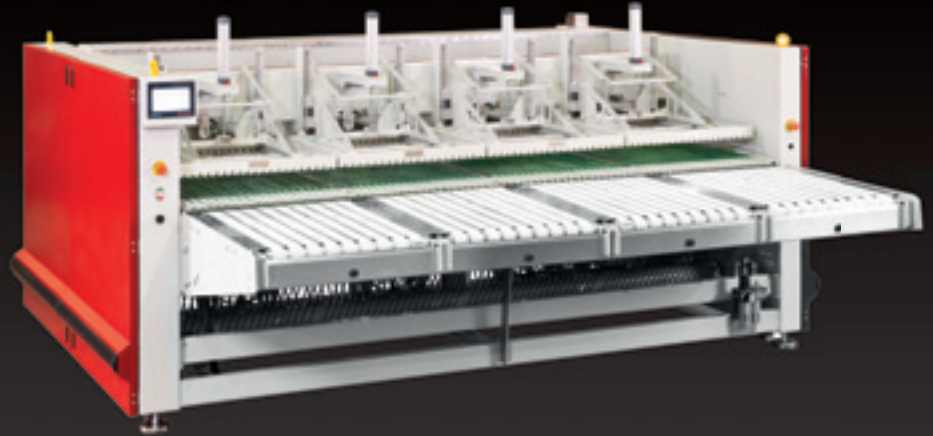

		3000	3300	3500
Working Speed	(m/min)	12-30	12-30	12-30
Capacity	(Pcs./hour)	3.600	3.600	3.600
Air Consumption	(lt/min)	540 (6-8 bar)	540 (6-8 bar)	540 (6-8 bar)
Motor Power	(Kw)	1,5	1,5	1,5
Stacking Dimensions	(cm)	72x55	80x55	85x55
Nr. of Split Input Conveyors		4	4	4
Width	(mm)	3.480	3.780	3.980
Depth	(mm)	3.530	3.530	3.530
Height	(mm)	1.650	1.650	1.650

VIRGO

Vacuum Feeder

3000 - 3300 - 3500 mm Width

Standard Features

- Vacuum Feeders are designed for huge capacity ironers in order to perform the most demanding high quality finishing tasks. It is suitable for linens, pillow cases, table napkins and table clothes.
- Ergonomic designed structure with high efficient centrifugal fans, a forceful airflow has created to catch, to flatten, to tauten and to feed the laundry.
- All movements such as string, bending, pulling fulfilled by operators normally, are done mechanically in order to achieve dramatically savings.
- Besides by reducing the gap of fed linens in between, efficiency of the ironer has been raised up.
- According to type of fed material, speed and vacuuming are adjustable whereas feeder relocates easily with carrier wheels.



Feeder Weight	(mm)	3.000
Working Speed	(m/min.)	6 - 36 adjustable
Motor Power (Total)	(Kw)	0,55
Fan Motor Power	(Kw)	4x0,75
Width	(mm)	3.465
Depth	(mm)	1.155
Height	(mm)	1.350
Weight	(Kg)	760

**AUTOMATIC SPEED
SYNCHRONIZATION WITH IRONING**

Tolkar reserves changing the technical specifications of the machines due to technological necessities without prior notice



VIRGO Towel Roller

Feeding Range	(mm)	650
Width	(mm)	935
Depth	(mm)	820
Depth	(mm)	535
Height	(mm)	140

Standard Features

- Compact and easy usage
- 200-300 pcs/hour capacity
- Bottom Shelf (Optional)

AUXILIARY EQUIPMENTS



Garment Conveyor



Packing Machine



Mobile Hanger Trolley



Single / Double Sink Unit
Stainless Steel
(90-120-140-160-180-190 cm)



Mobile Working Table
Stainless Steel
(90-140-180-190-240-290 cm)



Laundry Trolley
(270-280-500-900-
1000-2000 liters)



Stainless Steel Shelves
(90-120-140-160-180-190 cm)

AUXILIARY EQUIPMENTS

- Tolkar Dry Cleaning Machines
- Presses
- Narrow Type Ironing Tables
- Air Form Finishers
- Stain Removers
- Shirt Robots And Collar & Cuff Presses
- Trolleys
- Mobile Working Tables
- Shelves
- Sink Units
- Garment Hanger Trolleys
- Marking Machines
- Packing Machines
- Conveyor Systems
- Steam Generators
- Air Compressors
- Sewing And Overlook Machines

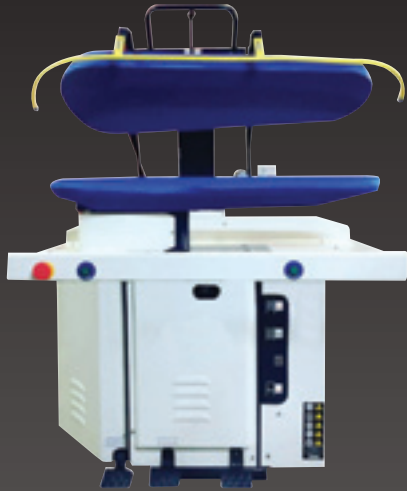

Pressing Machine
Manual / Pneumatic
Electric / Steam Heated

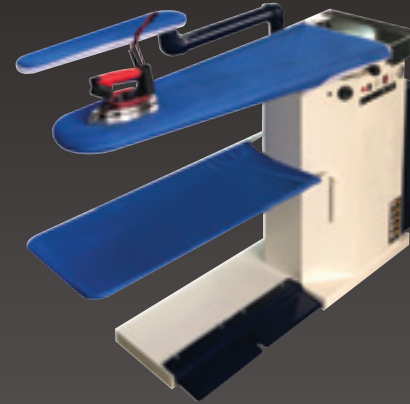

Narrow Type Ironing Table
Electric / Steam Heated

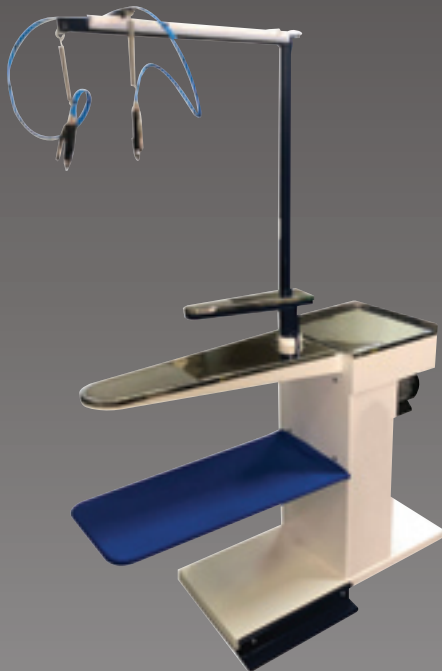

Stain Removal / Spotting Machine
Electric / Steam Heated



Air Form Finisher
Manual / Pneumatic
Electric / Steam Heated

COLMAC

Automatic Tunnel Finisher



		CFS 300	CFS 600	CFS 900	CFS 1200	CFS 2100
Heating Type		Steam/Gas	Steam/Gas	Steam/Gas	Steam/Gas	Steam/Gas
Workwear						
%30 Humidity Retention	Pcs./Hour	150	200	300	450	700
%35 Humidity Retention	Pcs./Hour	130	150	255	385	600
%40 Humidity Retention	Pcs./Hour	110	130	220	335	525
%45 Humidity Retention	Pcs./Hour	100	150	200	300	465

Minimized labour and maximized productivity with continuous system

Front to rear air flow

Maximum wrinkle free operation with active steam jets

Most advanced uniform ironing system

The most effective uniform ironing system

Stainless steel tunnel construction

Adjustable speed

PLC Controlled 7" Touch Screen Panel



TUNNEL WASHING SYSTEMS



DISTRIBUTORSHIPS



Speed Queen®

COLMAC

RENZACCI

EBIKO



COUNTRIES WE ARE EXPORTING TO

Afganistan	Kosovo
Albania	Kyrgyzstan
Algeria	Lebanon
Armenia	Libya
Aruba	Macedonia
Azerbaijan	Madagascar
Bangladesh	Maldives
Belarus	Mauritius
Belgium	Mexico
Bosna Herzigova	Morocco
Bulgaria	Netherlands
China	Norway
Colombia	Oman
Croatia	Pakistan
Denmark	Phillippines
Dominican Republic	Poland
Egypt	Portugal
Egypt	Qatar
England	Romania
Estonia	Russia
Ethiopia	Rwanda
France	Saudi Arabia
Georgia	Serbia
Germany	Slovakia
Ghana	South Africa
Greece	Spain
Greenland	Sri Lanka
Hungary	Sudan
India	Sweden
Indonesia	Syria
Iran	Tanzania
Iraq	Tunisia
Ireland	Tunisia
Israel	Turkmenistan
Italy	UAE
Jordan	Ukraine
Kazakhstan	USA
Kenya	Uzbekistan
Korea	Vietnam

info@tolkar.com.tr

www.tolkar.com.tr

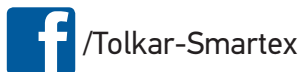

TOLKAR® SMARTEX®

Technological, Economical, Ecological Differences

Head Office & Factory: A.O.S.B. 10036 Sokak No:6 35620 Çigli - İzmir / TÜRKİYE

Factory 2: A.O.S.B. 10039 Sokak No:15 Çigli - İzmir / TÜRKİYE

Factory 3: A.O.S.B. Mustafa Kemal Bulvarı No:67 Çigli - İzmir / TÜRKİYE

Tel: +90 232 376 8500 (pbx) • Fax: +90 232 376 7658

export@tolkar.com.tr

www.tolkar.com.tr

