

# Banquet Carts

---

## Electric



1000-BQ2/96



1000-BQ2/128

### Models:

**1000-BQ2/96**

**1000-BQ2/128**

**1000-BQ2/192**



1000-BQ2/192

- **INSTALLATION**
- **OPERATION**
- **MAINTENANCE**



---

W164 N9221 Water Street • P.O. Box 450 • Menomonee Falls, Wisconsin 53052-0450 USA  
PHONE: 262.251.3800 • 800.558.8744 USA/CANADA      FAX: 262.251.7067 • 800.329.8744 U.S.A. ONLY  
[www.alto-shaam.com](http://www.alto-shaam.com)

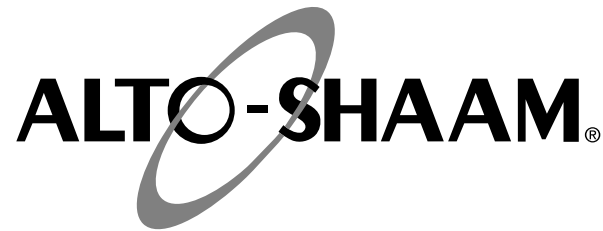

Delivery . . . . . 1  
Unpacking . . . . . 1  
Safety Procedures and Precautions . . . . . 2

**Installation**

Site Installation . . . . . 3  
Clearance Requirements . . . . . 3  
Dimension Drawings, weights & capacities . . . . . 4  
Plate Capacity . . . . . 5  
Options and Accessories . . . . . 6  
Electrical Specifications . . . . . 7

**Operating Instructions**

Start-Up . . . . . 8  
Holding Procedures . . . . . 9  
General Holding Guidelines . . . . . 10

**Care and Cleaning**

Cleaning and Preventative Maintenance . . . . . 11  
Protecting Stainless Steel Surfaces . . . . . 11  
Cleaning Agents . . . . . 11  
Cleaning Materials . . . . . 11  
Clean Daily . . . . . 12

**Sanitation**

Sanitation/Food Safety . . . . . 13

**Service**

Thermostat Accuracy . . . . . 14  
Trouble Shooting . . . . . 15  
Service View . . . . . 16  
Service Parts List . . . . . 17  
Split Door (FACTORY INSTALLED OPTION) . . . . . 18  
Trailer Hitch (FACTORY INSTALLED OPTION) . . . . . 19  
Trailer Hitch Safety . . . . . 19  
Cable Heating Kits . . . . . 20

**Wire Diagrams**

Always refer to the wire diagram(s) included with the unit for most current version.

**Warranty**

Transportation Damage and Claims . . . . . Back Cover  
Limited Warranty . . . . . Back Cover

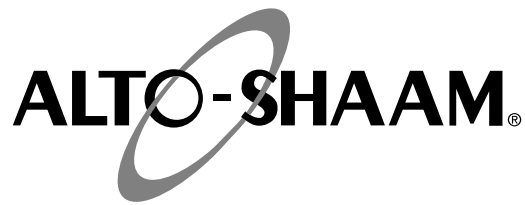

## DELIVERY

This Alto-Shaam appliance has been thoroughly tested and inspected to ensure only the highest quality unit is provided. Upon receipt, check for any possible shipping damage and report it at once to the delivering carrier. *See Transportation Damage and Claims section located in this manual.*

This appliance, complete with unattached items and accessories, may have been delivered in one or more packages. Check to ensure that all standard items and options have been received with each model as ordered.

Save all the information and instructions packed with the appliance. Complete and return the warranty card to the factory as soon as possible to ensure prompt service in the event of a warranty parts and labor claim.

This manual must be read and understood by all people using or installing the equipment model. Contact the Alto-Shaam Tech Team Service Department if you have any questions concerning installation, operation, or maintenance.

**NOTE:** All claims for warranty must include the full model number and serial number of the unit.

## UNPACKING

1. Carefully remove the appliance from the carton or crate.

**NOTE:** Do not discard the carton and other packaging material until you have inspected the unit for hidden damage and tested it for proper operation.

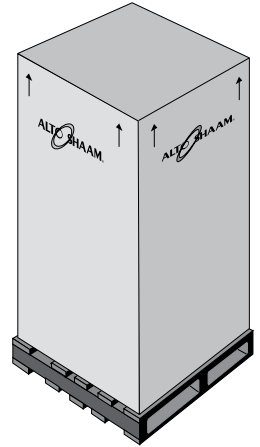

2. Read all instructions in this manual carefully before initiating the installation of this appliance.

**DO NOT DISCARD THIS MANUAL.**

This manual is considered to be part of the appliance and is to be provided to the owner or manager of the business or to the person responsible for training operators. *Additional manuals are available from the Alto-Shaam Tech Team Service Department.*

3. Remove all protective plastic film, packaging materials, and accessories from the appliance before connecting electrical power. Store any accessories in a convenient place for future use.

## SAFETY PROCEDURES AND PRECAUTIONS

Knowledge of proper procedures is essential to the safe operation of electrically and/or gas energized equipment. In accordance with generally accepted product safety labeling guidelines for potential hazards, the following signal words and symbols may be used throughout this manual.

### DANGER



Used to indicate the presence of a hazard that **WILL** cause severe personal injury, death, or substantial property damage if the warning included with this symbol is ignored.

### WARNING



Used to indicate the presence of a hazard that **CAN** cause personal injury, possible death, or major property damage if the warning included with this symbol is ignored.

### CAUTION



Used to indicate the presence of a hazard that can or will cause minor or moderate personal injury or property damage if the warning included with this symbol is ignored.

### CAUTION

Used to indicate the presence of a hazard that can or will cause minor personal injury, property damage, or a potential unsafe practice if the warning included with this symbol is ignored.

**NOTE:** Used to notify personnel of installation, operation, or maintenance information that is important but not hazard related.

1. This appliance is intended to cook, hold or process foods for the purpose of human consumption. No other use for this appliance is authorized or recommended.
2. This appliance is intended for use in commercial establishments where all operators are familiar with the purpose, limitations, and associated hazards of this appliance. Operating instructions and warnings must be read and understood by all operators and users.
3. Any troubleshooting guides, component views, and parts lists included in this manual are for general reference only and are intended for use by qualified technical personnel.
4. This manual should be considered a permanent part of this appliance. This manual and all supplied instructions, diagrams, schematics, parts lists, notices, and labels must remain with the appliance if the item is sold or moved to another location.

### NOTE

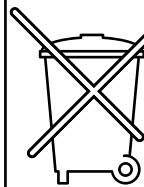

For equipment delivered for use in any location regulated by the following directive:

**DO NOT DISPOSE OF ELECTRICAL OR ELECTRONIC EQUIPMENT WITH OTHER MUNICIPAL WASTE.**



Used to indicate that referral to operating instructions is a mandatory action. If not followed the operator could suffer personal injury.



Used to indicate that referral to operating instructions is recommended to understand operation of equipment.

# INSTALLATION

## SITE INSTALLATION

This appliance, complete with unattached items and accessories, may be delivered in one or more packages. Check to insure that all the following items have been received as standard with each unit:

Item	BQ2/96	BQ2/128	BQ2/192
Shelves	4	4	8
Shelf Clips	4	4	8
Shelf Slides	8	8	16

This appliance is designed for the purpose of maintaining hot food at a temperature for safe consumption. It must be used on a level surface in a location that will permit the the banquet cart to function for its intended purpose and allow adequate access for proper cleaning and maintenance.

The unit must not be installed in any area where it may be affected by steam, grease, dripping water, high temperatures, or any other severely adverse conditions.

## DANGER



**IMPROPER INSTALLATION, ALTERATION, ADJUSTMENT, SERVICE, OR MAINTENANCE COULD RESULT IN SEVERE INJURY, DEATH, OR CAUSE PROPERTY DAMAGE.**

**READ THE INSTALLATION, OPERATING AND MAINTENANCE INSTRUCTIONS THOROUGHLY BEFORE INSTALLING OR SERVICING THIS EQUIPMENT.**

## CAUTION



**TO PREVENT PERSONAL INJURY, USE CAUTION WHEN MOVING OR LEVELING THIS APPLIANCE.**

### CLEARANCE REQUIREMENTS

Full perimeter bumper accommodates all clearance requirements.

WEIGHT	1000-BQ2/96	1000-BQ2/128	1000-BQ2/192
NET	322 lbs (146 kg)	370 lbs (168 kg)	618 lbs (280 kg)
SHIP	415 lbs (188 kg)	485 lbs (220 kg)	750 lbs (340 kg)

# INSTALLATION

## SITE INSTALLATION

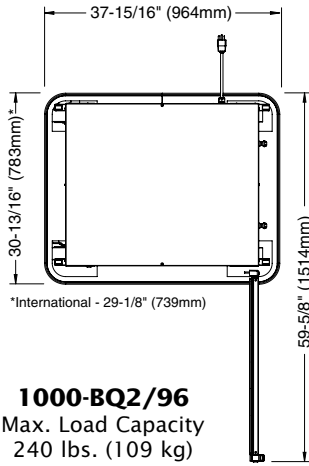

**1000-BQ2/96**  
 Max. Load Capacity  
 240 lbs. (109 kg)  
 240 qts. (304 lt)

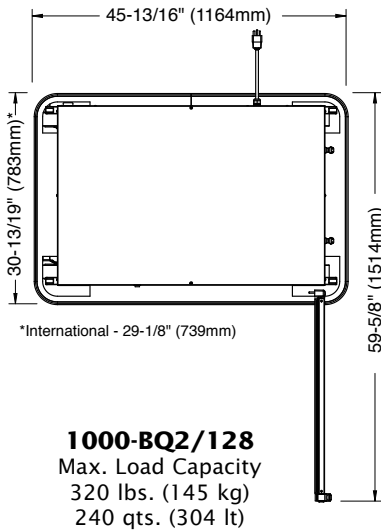
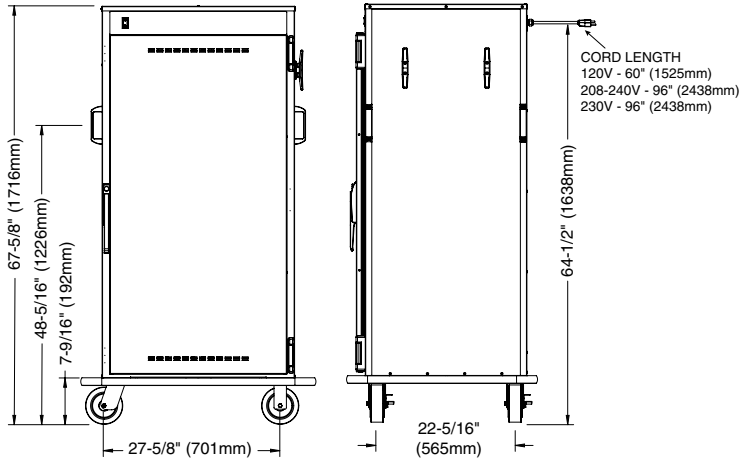

**1000-BQ2/128**  
 Max. Load Capacity  
 320 lbs. (145 kg)  
 240 qts. (304 lt)

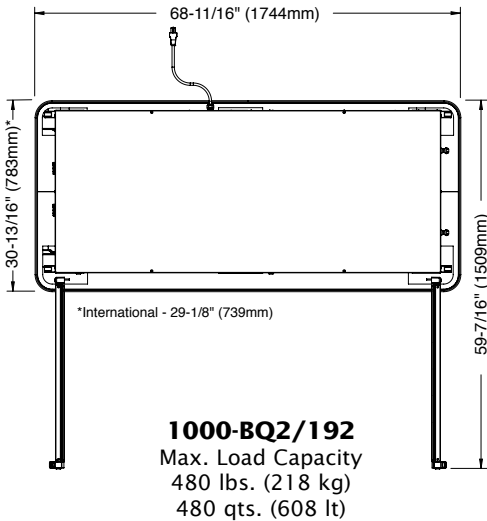
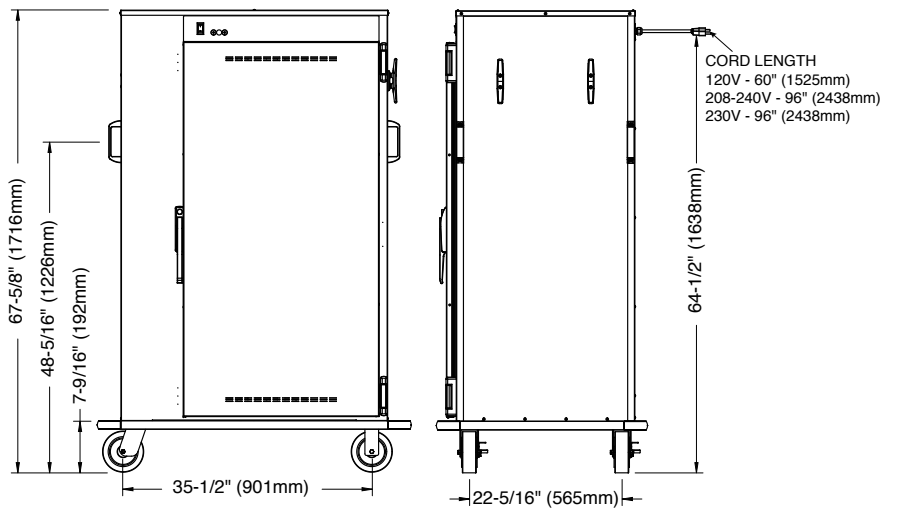

**1000-BQ2/192**  
 Max. Load Capacity  
 480 lbs. (218 kg)  
 480 qts. (608 lt)

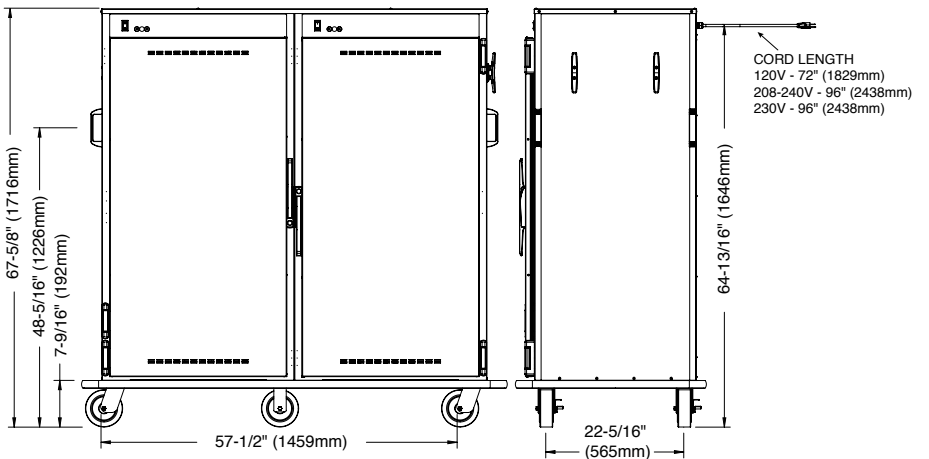

# INSTALLATION

## CAPACITY

**Plate Capacity** (16 plates high, 3" plate height)

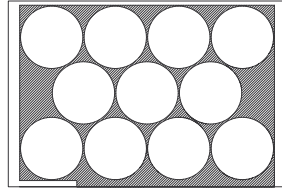

8" - 8-3/4"  
176 Plates

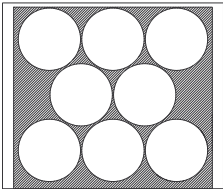

8" - 8-3/4"  
128 Plates

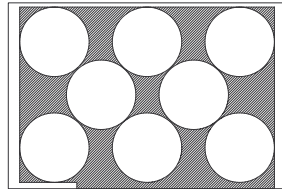

9" - 10"  
128 Plates

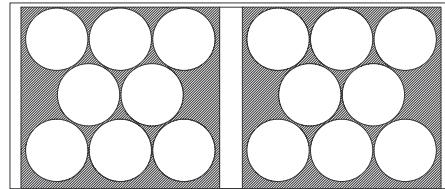

8" - 8-3/4"  
256 Plates

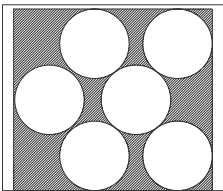

9" - 10"  
96 Plates

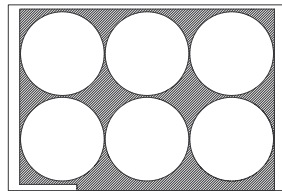

10-1/4" - 11-3/4"  
96 Plates

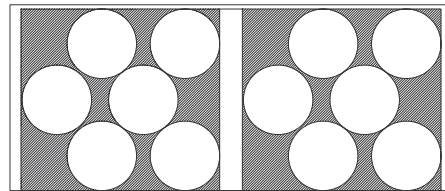

9" - 10"  
192 Plates

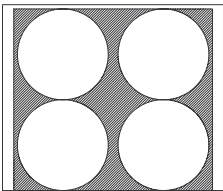

10-1/4" - 12-3/4"  
64 Plates

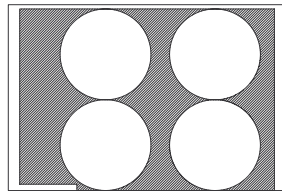

12" - 12-3/4"  
64 Plates

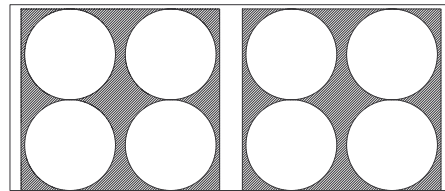

10-1/4" - 12-3/4"  
128 Plates

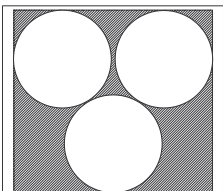

13"  
48 Plates

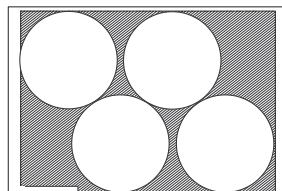

13"  
64 Plates

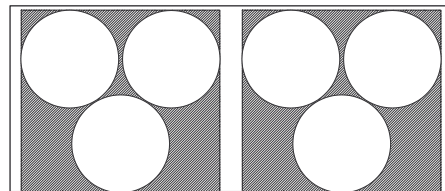

13"  
96 Plates

**BQ2-96**

**BQ2-128**

**BQ2-192**

# INSTALLATION

## Options and Accessories

Plate Carriers, Chrome Plated (EACH HOLDS FOUR (4) PREPLATED MEALS)	<b>1000-BQ2/96 Capacity</b>	<b>1000-BQ2/128 Capacity</b>	<b>1000-BQ2/192 Capacity</b>
Uncovered "P" Carriers Plate Diameter: Max. 10" (254mm) Min. 7-3/4" (197mm) Vertical rung spacing: 2-5/8" (67mm)	DC-2868 24 carriers 96 preplated meals	DC-2868 32 carriers 128 preplated meals	DC-2868 48 carriers 192 preplated meals
Covered "C" Carriers Plate Diameter: Max. 9-3/4" (248mm) Min. 7-3/4" (197mm) Vertical clearance between top and bottom carrier: 11-5/8" (295mm)	DC-2869 24 carriers 96 preplated meals	DC-2869 32 carriers 128 preplated meals	DC-2869 48 carriers 192 preplated meals
Uncovered "EP" Carriers Plate Diameter: Max. 12-1/2" (318mm) Min. 9-1/2" (241mm) Vertical rung spacing: 2-5/8" (67mm)	DC-23580 16 carriers 64 preplated meals	DC-23580 24 carriers 96 preplated meals	DC-23580 32 carriers 128 preplated meals
Covered "EC" Carriers Plate Diameter: Max. 12-1/2" (318mm) Min. 9-1/2" (241mm) Vertical clearance between top and bottom carrier: 11-5/8" (295mm)	DC-23676 16 carriers 64 preplated meals	DC-23676 24 carriers 96 preplated meals	DC-23676 32 carriers 128 preplated meals
Shelf Support (2 req'd for each shelf)	1061	1061	1061
Shelf Support Clip (1 req'd for each shelf)	11533	11533	11533
Wire Shelf, Chrome Plated	SH-2835	SH-22727	SH-2835
Door Lock with Key	LK-22567	LK-22567	LK-22567
Security Devices - includes tamper-proof screws, control panel security cover, and door lock	5013816	5013816	5013816
Trailer Hitch (FACTORY INSTALLED)	CONTACT FACTORY	CONTACT FACTORY	CONTACT FACTORY
Split Door(s) (FACTORY INSTALLED)	5016853	5016929	5016934

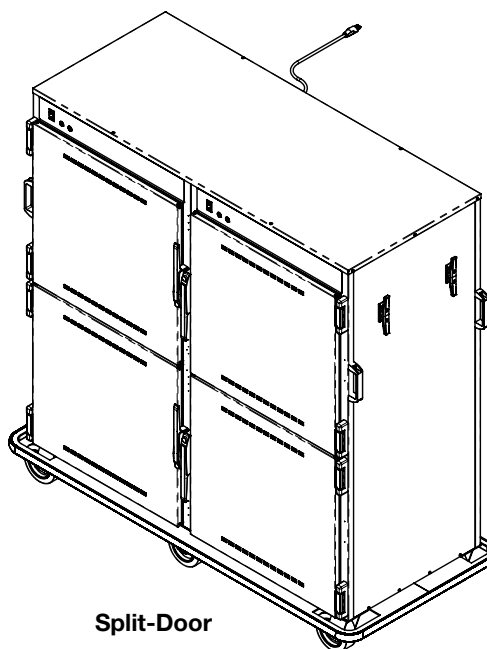
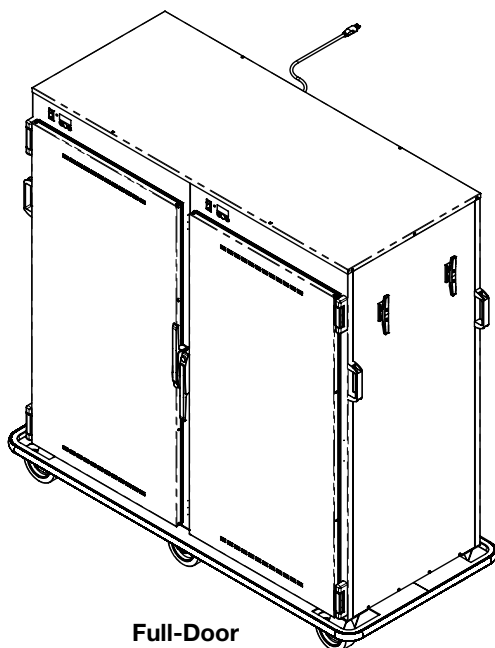



# INSTALLATION

## ELECTRICAL CONNECTION



### DANGER



**ENSURE POWER SOURCE MATCHES VOLTAGE IDENTIFIED ON APPLIANCE RATING TAG.**



### DANGER



**ELECTRICAL CONNECTIONS MUST BE MADE BY A QUALIFIED SERVICE TECHNICIAN IN ACCORDANCE WITH APPLICABLE ELECTRICAL CODES.**



### DANGER



**To avoid electrical shock, this appliance MUST be adequately grounded in accordance with local electrical codes or, in the absence of local codes, with the current edition of the National Electrical Code ANSI/NFPA No. 70. In Canada, all electrical connections are to be made in accordance with CSA C22.1, Canadian Electrical Code Part 1 or local codes.**

1. An identification tag is permanently mounted on the cabinet.
2. Plug cabinet into a properly grounded receptacle **ONLY**, positioning the unit so the power supply cord is easily accessible in case of an emergency.
3. If necessary, a proper receptacle or outlet configuration as required for this unit, must be installed by a licensed electrician in accordance with applicable, local electrical codes.

**NOTE:** Where local codes and CE regulatory requirements apply, appliances must be connected to an electrical circuit that is protected by an external GFCI outlet.

**For CE approved units:** To prevent an electrical shock hazard between the appliance and other appliances or metal parts in close vicinity, an equalization-bonding stud is provided. An equalization bonding lead must be connected to this stud and the other appliances/metal parts to provide sufficient protection against potential difference. The terminal is marked with the following symbol.







### Hard wired models:





Hard wired models must be equipped with a country certified external allpole disconnection switch with sufficient contact separation.

If a power cord is used for the connection of the product an oil resistant cord like H05RN or H07RN or equivalent must be used.







### ELECTRICAL • 1000-BQ2/96

VOLTAGE	PHASE	CYCLE/HZ	AMPS	kW	CORD & PLUG
120	1	60	12.5	1.5	 NEMA 5-15P 15A- 125V PLUG
208	1	60	5.9	1.2	 NEMA 6-15P 15A - 250V PLUG
240	1	60	6.8	1.6	
230	1	50/60	6.5	1.5	 CEE 7/7 PLUG RATED 250V  CH2-16P PLUG RATED 250V  BS 1363 (U.K. ONLY) PLUG RATED 250V

### ELECTRICAL • 1000-BQ2/128

VOLTAGE	PHASE	CYCLE/HZ	AMPS	kW	CORD & PLUG INCLUDED
120	1	60	17.5	2.1	 NEMA 5-30P 30A- 125V PLUG
208	1	60	7.7	1.6	 NEMA 6-15P 15A - 250V PLUG
240	1	60	8.9	2.1	
230	1	50/60	8.4	2.0	 CEE 7/7 PLUG RATED 250V  CH2-16P PLUG RATED 250V  BS 1363 (U.K. ONLY) PLUG RATED 250V

### ELECTRICAL • 1000-BQ2/192

VOLTAGE	PHASE	CYCLE/HZ	AMPS	kW	CORD & PLUG INCLUDED
120	1	60	24.0	2.9	 NEMA 5-20P 20A- 125V PLUG
POWER SWITCH IN LOW POSITION			16.0	1.9	
POWER SWITCH IN HIGH POSITION			25.0 MAX	3.0	 NEMA 5-30P 30A - 125V PLUG
208	1	60	11.8	2.5	 NEMA 6-15P 15A - 250V PLUG
240	1	60	13.6	3.3	
230	1	50/60	13.0	3.0	 CEE 7/7 PLUG RATED 250V  CH2-16P PLUG RATED 250V  BS 1363 (U.K. ONLY) PLUG RATED 250V

Wire diagrams are located inside the top of the unit.

# OPERATION

## OPERATING INSTRUCTIONS

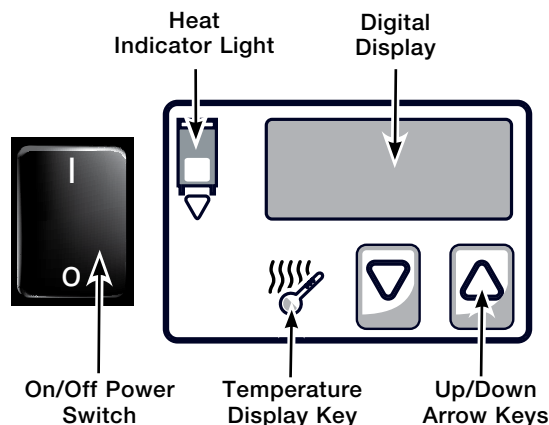

### 1. PREHEAT AT 200°F (93°C) FOR 30 MINUTES BEFORE LOADING FOOD.

Push power switch to “ON” position. The unit will begin operating at the previous set temperature.

2. Press the **Up** or **Down Arrow Keys** to 200°F (93°C). Pressing and releasing the Arrow Keys will increase the set point by 1 degree. Pressing and holding the Arrow Key will increase set point by 10 degrees. When Arrow Key is released, a new set point temperature is set. The *Set* temperature will appear in the **Digital Display** and the **Heat Indicator Light** will illuminate. Press the **Temperature Display Key** for three seconds at any time to display the *Actual* inside air temperature.

#### To toggle between *Set* and *Actual*:

Factory default is to display *Set* temperature in the **Digital Display**. To display *Actual* temperature:

Press and hold the **Temperature Display Key** and the **Up Arrow Key** for 5 seconds. The control will show **ACT**, then show the *Actual* temperature.

Repeat to toggle to *Set* point **SET**.

Press the **Temperature Display Key** at any time to display the alternate temperature.

3. When the inside air temperature reaches the desired holding temperature, the **Heat Indicator Light** will turn off.

### 4. Load the cabinet with hot food only.

The purpose of the holding cabinet is to maintain hot food at proper serving temperatures. Only hot food should be placed into the cabinet. Before loading the unit with food, use a food thermometer to make certain all food products are at an internal temperature range of 140° to 160°F (60° to 71°C). All food not within the proper temperature range should be heated before loading into the holding cabinet.

5. Check to make certain the cabinet door is securely closed, and using the **Up** and **Down Arrow Keys**, set the temperature to 160°F (71°C).

#### THIS WILL NOT NECESSARILY BE THE FINAL SETTING.

The proper temperature range for the food being held will depend on the type and quantity of product. Whether or not the door vents should be open or closed will also depend on the type of food being held. When holding food for prolonged periods, it is advisable to periodically check the internal temperature of each item to assure maintenance of the proper temperature range. Reset the holding temperature accordingly.

#### TO TOGGLE BETWEEN FAHRENHEIT AND CELSIUS

*Press the Temperature Display Key at any time to display the alternate temperature.*

The factory default is Fahrenheit. To change to Celsius:

1. Press and hold the **Temperature Display Key** and the **Down Arrow Key** for 5 seconds.
2. The control will show **°C** for 3 seconds to verify selection and then show the temperature. (Set Point or Actual, whichever the user has selected) in °C.
3. Repeat to toggle to Fahrenheit.

*Note: With a power failure, factory test, etc., the control will retain the °C or °F setting selected by the user when power is restored.*

# OPERATING INSTRUCTIONS

## HOLDING PROCEDURE

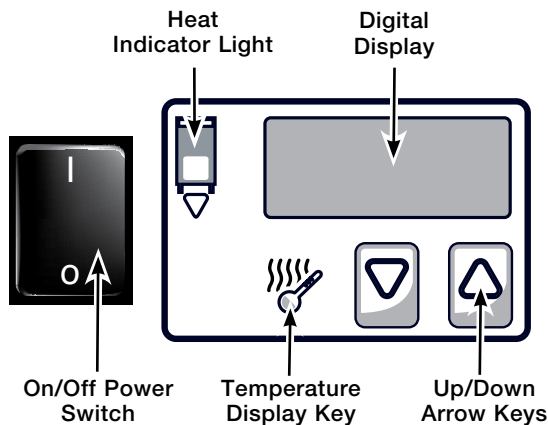

### 1. Preheat at 200°F for 30 minutes.

Allow a minimum of 30 minutes for preheating before loading the banquet cart with product.

### 2. Load the cart with hot food only.

The purpose of the banquet cart is to maintain hot food at proper serving temperature. Only hot food should be placed into the banquet cart. Before loading the cart with food, use a food thermometer to make certain all products have reached an internal temperature range of 140° to 160°F (60° to 71°C). Any food product not within the proper temperature range should be heated before loading into the banquet cart. For best results, use a Halo Heat Low Temperature Cooking and Holding Oven set at 250° to 275°F (121° to 135°C), or a Combitherm oven, to bring the product within the correct temperature range.

### 3. Load covered plates or carriers into the banquet cart.

After the food has reached proper serving temperature:

- A. Use HEATED plates only.
- B. Load each series of four (4) plates into the banquet cart as soon as assembled and as quickly as possible to retain maximum heat.
- C. Load the plates in the upper section of the banquet cart first.
- D. Securely close the door(s) of the banquet cart after loading.

### 4. Reset the thermostat to desired temperature.

After the cart has been completely filled with product, check to make certain the doors are securely closed, and reset the thermostat to the desired holding temperature or the suggested 180°F (82°C).

The proper temperature range for the products being held, and whether or not to open or close the door vents, will depend on the type and quantity of product. When holding food for prolonged periods, it is advisable to periodically check the internal temperature of each item with a food thermometer to assure maintenance of the proper temperature range of 140° to 160°F (60° to 71°C).

### 5. Unload covered plates, trays or plate carriers as needed.

- A. Unload the items from the lower section of the cart first, and work up toward the top of the cart.
- B. Securely close the door(s) of the cart after each product removal.

# OPERATING INSTRUCTIONS

## General Holding Guideline

Chefs, cooks and other specialized food service personnel employ varied methods of cooking. Proper holding temperatures for a specific food product must be based on the moisture content of the product, product density, volume, and proper serving temperatures. Safe holding temperatures must also be correlated with palatability in determining the length of holding time for a specific product.

Halo Heat maintains the maximum amount of product moisture content without the addition of water, water vapor, or steam. Maintaining maximum natural product moisture preserves the natural flavor of the product and provides a more genuine taste. In addition to product moisture retention, the gentle properties of Halo Heat maintain a consistent temperature throughout the cabinet without the necessity of a heat distribution fan, thereby preventing further moisture loss due to evaporation or dehydration.

When product is removed from a high temperature cooking environment for immediate transfer into equipment with the lower temperature required for hot food holding, condensation can form on the outside of the product and on the inside of plastic containers used in self-service applications. Allowing the product to release the initial steam and heat produced by high temperature cooking can alleviate this condition. To preserve the safety and quality of freshly cooked foods however, a maximum of 1 to 2 minutes must be the only time period allowed for the initial heat to be released from the product.

Most Halo Heat holding equipment is provided with a thermostat control between 60° and 200°F (16° to 93°C). If the unit is equipped with vents, close the vents for moist holding and open the vents for crisp holding.

If the unit is equipped with a thermostat indicating a range of between 1 and 10, use a metal-stemmed indicating thermometer to measure the internal temperature of the product(s) being held. Adjust the thermostat setting to achieve the best overall setting based on internal product temperature.

HOLDING TEMPERATURE RANGE		
MEAT	FAHRENHEIT	CELSIUS
BEEF ROAST — Rare	130°F	54°C
BEEF ROAST — Med/Well Done	155°F	68°C
BEEF BRISKET	160° — 175°F	71° — 79°C
CORN BEEF	160° — 175°F	71° — 79°C
PASTRAMI	160° — 175°F	71° — 79°C
PRIME RIB — Rare	130°F	54°C
STEAKS — Broiled/Fried	140° — 160°F	60° — 71°C
RIBS — Beef or Pork	160°F	71°C
VEAL	160° — 175°F	71° — 79°C
HAM	160° — 175°F	71° — 79°C
PORK	160° — 175°F	71° — 79°C
LAMB	160° — 175°F	71° — 79°C
POULTRY		
CHICKEN — Fried/Baked	160° — 175°F	71° — 79°C
DUCK	160° — 175°F	71° — 79°C
TURKEY	160° — 175°F	71° — 79°C
GENERAL	160° — 175°F	71° — 79°C
FISH/SEAFOOD		
FISH — Baked/Fried	160° — 175°F	71° — 79°C
LOBSTER	160° — 175°F	71° — 79°C
SHRIMP — Fried	160° — 175°F	71° — 79°C
BAKED GOODS		
BREADS/ROLLS	120° — 140°F	49° — 60°C
MISCELLANEOUS		
CASSEROLES	160° — 175°F	71° — 79°C
DOUGH — Proofing	80° — 100°F	27° — 38°C
EGGS — Fried	150° — 160°F	66° — 71°C
FROZEN ENTREES	160° — 175°F	71° — 79°C
HORS D'OEUVRES	160° — 180°F	71° — 82°C
PASTA	160° — 180°F	71° — 82°C
PIZZA	160° — 180°F	71° — 82°C
POTATOES	180°F	82°C
PLATED MEALS	140° — 165°F	60° — 74°C
SAUCES	140° — 200°F	60° — 93°C
SOUP	140° — 200°F	60° — 93°C
VEGETABLES	160° — 175°F	71° — 79°C
<b>THE HOLDING TEMPERATURES LISTED ARE SUGGESTED GUIDELINES ONLY. ALL FOOD HOLDING SHOULD BE BASED ON INTERNAL PRODUCT TEMPERATURES. ALWAYS FOLLOW LOCAL HEALTH (HYGIENE) REGULATIONS FOR ALL INTERNAL TEMPERATURE REQUIREMENTS.</b>		

# CARE AND CLEANING

## CLEANING AND PREVENTATIVE MAINTENANCE

### PROTECTING STAINLESS STEEL SURFACES



It is important to guard against corrosion in the care of stainless steel surfaces. Harsh, corrosive, or inappropriate chemicals can completely destroy the protective surface layer of stainless steel. Abrasive pads, steel wool, or metal implements will abrade surfaces causing damage to this protective coating and will eventually result in areas of corrosion. Even water, particularly hard water that contains high to moderate concentrations of chloride, will cause oxidation and pitting that result in rust and corrosion. In addition, many acidic foods spilled and left to remain on metal surfaces are contributing factors that will corrode surfaces.



Proper cleaning agents, materials, and methods are vital to maintaining the appearance and life of this appliance. Spilled foods should be removed and the area wiped as soon as possible but at the very least, a minimum of once a day. Always thoroughly rinse surfaces after using a cleaning agent and wipe standing water as quickly as possible after rinsing.

### CLEANING AGENTS

Use non-abrasive cleaning products designed for use on stainless steel surfaces. Cleaning agents must be chloride-free compounds and must not contain quaternary salts. Never use hydrochloric acid (muriatic acid) on stainless steel surfaces. Always use the proper cleaning agent at the manufacturer's recommended strength. Contact your local cleaning supplier for product recommendations.

### CLEANING MATERIALS

The cleaning function can usually be accomplished with the proper cleaning agent and a soft, clean cloth. When more aggressive methods must be employed, use a non-abrasive scouring pad on difficult areas and make certain to scrub with the visible grain of surface metal to avoid surface scratches. Never use wire brushes, metal scouring pads, or scrapers to remove food residue.

 <b>CAUTION</b>	
 <b>NO SCRAPERS</b>	<b>TO PROTECT STAINLESS STEEL SURFACES, COMPLETELY AVOID THE USE OF ABRASIVE CLEANING COMPOUNDS, CHLORIDE BASED CLEANERS, OR CLEANERS CONTAINING QUATERNARY SALTS. NEVER USE HYDROCHLORIC ACID (MURIATIC ACID) ON STAINLESS STEEL. NEVER USE WIRE BRUSHES, METAL SCOURING PADS OR SCRAPERS.</b>
 <b>NO WIRE BRUSHES</b>	
 <b>NO STEEL PADS</b>	

# CARE AND CLEANING



The cleanliness and appearance of this unit will contribute considerably to operating efficiency and savory, appetizing food. Good equipment kept clean works better and lasts longer.

1. Disconnect unit from power source, and let cool.
2. Remove all detachable items such as plate carriers, shelves and side racks. Clean these items separately with a good grease solvent or commercial detergent. Rinse well and dry.
3. Clean interior metal surfaces of the unit with damp, clean cloth and any good commercial detergent or grease solvent at the recommended strength. Spray heavily soiled areas with a water soluble degreaser and let stand for 10 minutes, then remove soil with a plastic scouring pad. Rinse by wiping with a sponge and clean warm water to remove all residue. Remove excess water with sponge and wipe dry with a clean cloth or air dry. Replace side racks and shelves.





**NOTE:** Avoid the use of abrasive cleaning, compounds, chloride based cleaners, or cleaners containing quaternary salts. Never use hydrochloric acid (muriatic acid) on stainless steel.

4. Clean control panel, door vents, door handles, and door gaskets thoroughly since these areas harbor food debris. Rinse by wiping with sponge and clean warm water. Wipe dry with a clean cloth.

5. Interior can be wiped with a sanitizing solution after cleaning and rinsing. This solution must be approved for use on stainless steel food contact surfaces.
6. To help maintain the protective film coating on polished stainless steel, clean the exterior of the unit with a cleaner recommended for stainless steel surfaces. Spray the cleaning agent on a clean cloth and wipe with the grain of the stainless steel.

Always follow appropriate state or local health (hygiene) regulations regarding all applicable cleaning and sanitation requirements for foodservice equipment.

<b>⚠ DANGER</b>	
	<b>DISCONNECT UNIT FROM POWER SOURCE BEFORE CLEANING OR SERVICING.</b>

<b>⚠ DANGER</b>	
	<b>AT NO TIME SHOULD THE INTERIOR OR EXTERIOR BE STEAM CLEANED, HOSED DOWN, OR FLOODED WITH WATER OR LIQUID SOLUTION OF ANY KIND. DO NOT USE WATER JET TO CLEAN.</b>
	<b>SEVERE DAMAGE OR ELECTRICAL HAZARD COULD RESULT.</b>
<b>WARRANTY BECOMES VOID IF APPLIANCE IS FLOODED</b>	

# SANITATION

Food flavor and aroma are usually so closely related that it is difficult, if not impossible, to separate them. There is also an important, inseparable relationship between cleanliness and food flavor. Cleanliness, top operating efficiency, and appearance of equipment contribute considerably to savory, appetizing foods. Good equipment that is kept clean, works better and lasts longer.

Most food imparts its own particular aroma and many foods also absorb existing odors. Unfortunately, during this absorption there is not distinction between GOOD and BAD odors. The majority of objectionable flavors and odors troubling food service operations are caused by bacteria growth. Sourness, rancidity, mustiness, stale or other OFF flavors are usually the result of germ activity.

The easiest way to insure full, natural food flavor is through comprehensive cleanliness. This means good control of both visible soil (dirt) and invisible soil (germs). A thorough approach to sanitation will provide essential cleanliness. It will assure an attractive appearance of equipment, along with maximum efficiency and utility. More importantly, a good sanitation program provides one of the key elements in the prevention of food-borne illnesses.

A controlled holding environment for prepared foods is just one of the important factors involved in the prevention of food-borne illnesses. Temperature monitoring and control during receiving, storage, preparation, and the service of foods are of equal importance.

The most accurate method of measuring safe temperatures of both hot and cold foods is by internal product temperature. A quality thermometer is an effective tool for this purpose, and should be routinely used on all products that require holding at a specific temperature.

A comprehensive sanitation program should focus on the training of staff in basic sanitation procedures. This includes personal hygiene, proper handling of raw foods, cooking to a safe internal product temperature, and the routine monitoring of internal temperatures from receiving through service.

Most food-borne illnesses can be prevented through proper temperature control and a comprehensive program of sanitation. Both these factors are important to build quality service as the foundation of customer satisfaction. Safe food handling practices to prevent food-borne illness is of critical importance to the health and safety of your customers.

HACCP, an acronym for Hazard Analysis (at) Critical Control Points, is a quality control program of operating procedures to assure food integrity, quality, and safety. Taking steps necessary to augment food safety practices is both cost effective and relatively simple. While HACCP guidelines go far beyond the scope of this manual, additional information is available by contacting:

**CENTER FOR FOOD SAFETY AND APPLIED  
NUTRITION FOOD AND DRUG ADMINISTRATION  
1-888-SAFEFOOD**

INTERNAL FOOD PRODUCT TEMPERATURES		
<b>HOT FOODS</b>		
DANGER ZONE	40° TO 140°F	(4° TO 60°C)
CRITICAL ZONE	70° TO 120°F	(21° TO 49°C)
SAFE ZONE	140° TO 165°F	(60° TO 74°C)
<b>COLD FOODS</b>		
DANGER ZONE	ABOVE 40°F	(ABOVE 4°C)
SAFE ZONE	36° TO 40°F	(2° TO 4°C)
<b>FROZEN FOODS</b>		
DANGER ZONE	ABOVE 32°F	(ABOVE 0°C)
CRITICAL ZONE	0° TO 32°F	(-18° TO 0°C)
SAFE ZONE	0°F or below	(-18°C or below)

# SERVICE



## THERMOSTAT ACCURACY

The electronic thermostat is a precise instrument and is designed to offer trouble free service. If you suspect the temperature inside the holding compartment does not match the temperature indicated on the digital display, follow the instructions listed below.

- 1.** Check to make certain the unit voltage matches the power source. A power source less than that required to operate the unit will result in inaccurate temperatures.
- 2.** Verify the temperature inside the holding compartment with a qualify thermal indicator.
  - A.** With the exception of the wire shelves, completely empty the holding compartment.
  - B.** Make certain the holding cabinet sensor, located inside the holding compartment at the left side of the unit, is completely clean.
  - C.** Suspend the thermal indicator in the center of the holding compartment.
  - D.** Allow the temperature set on the electronic thermostat to stabilize for a minimum of one hour before comparing the digital display with the reading on the thermal indicator.

DO NOT OPEN THE CABINET DOOR(S) DURING THE  
TEMPERATURE STABILIZATION PERIOD.

If the reading on the thermal indicator does not match the digital display, there may be a problem with the air sensor. See troubleshooting guide in this manual; or call the factory service department for advice.

	<b>DANGER</b>
	<b>DISCONNECT UNIT FROM POWER SOURCE BEFORE CLEANING OR SERVICING.</b>

<b>CAUTION</b>
<b>THIS SECTION IS PROVIDED FOR THE ASSISTANCE OF QUALIFIED SERVICE TECHNICIANS ONLY AND IS NOT INTENDED FOR USE BY UNTRAINED OR UNAUTHORIZED SERVICE PERSONNEL.</b>





# SERVICE

## TROUBLESHOOTING

Code	Description	Possible Cause
E-10	<b>Cavity air sensor shorted</b>	Cavity air sensor reading < 5°F (-15°C). Verify sensor integrity. See sensor test instructions below.
E-11	<b>Cavity air sensor open</b>	Cavity air sensor reading > 517°F (269°C). Verify sensor integrity. See sensor test instructions below.
E-20	<b>Product probe is shorted</b> <i>Oven will cook in time only</i>	Product probe reading < 5°F (-15°C). Verify sensor integrity. See sensor test instructions below.
E-21	<b>Product probe is open</b> <i>Oven will cook in time only</i>	Product Probe reading > 517°F (269°C). Verify sensor integrity. See sensor test instructions below.
E-30	<b>Under temperature</b>	Unit has not reached (set-point - 25°F (4°C)) for more than 90 minutes.
E-31	<b>Over temperature</b>	Unit has been higher than 60°F (16°C) above the maximum cavity set-point for more than 3 minutes. <b>Note:</b> Holding Cabinets with this error code are more than 145°F (63°C) higher than the maximum set-point.
E-32	<b>Safety switch open (Aux hi-limit switch)</b>	Contact factory.
E-38	<b>Internal software error</b>	Contact factory.
E-39	<b>Sensor error</b>	Contact factory.
E-50	<b>Temp. measurement error</b>	Contact factory.
E-51	<b>Temp. measurement error</b>	Contact factory.
E-60	<b>Real time clock error</b>	Data set to factory default. Ensure that date and time are correct if applicable.
E-61	<b>Real time clock error</b>	Contact factory.
E-64	<b>Clock is not oscillating</b>	Contact factory.
E-70	<b>Configuration connector error (DIP switch)</b>	Refer to wiring diagram for the particular model and ensure dip switches on the control match the settings called out on the WD. If the dip switch settings are correct according to the print replace the control.
E-78	<b>Voltage low</b>	Voltage below 90 VAC on a 125 VAC unit, or below 190 VAC on a 208-240 VAC unit. Correct voltage.
E-79	<b>Voltage high</b>	Voltage over 135 VAC on a 125 VAC unit, or over 250 VAC on a 208-240 VAC unit. Correct voltage.
E-80	<b>EEPROM Error</b>	Ensure that all temperatures and times are properly set. Contact factory if problem persists.
E-81	<b>EEPROM Error</b>	Contact factory.
E-82	<b>EEPROM Error</b>	Contact factory.
E-83	<b>EEPROM Error</b>	Contact factory.
E-85	<b>EEPROM Error</b>	All timers, if previously on, are now off. Possible bad EEPROM.
E-86	<b>EEPROM Error</b>	Stored HACCP memory corrupted. HACCP Address reset to 1. Possible bad EEPROM. Contact factory if problem persists.
E-87	<b>EEPROM Error</b>	Stored offsets corrupted. Offsets reset to 0. Control may need a recalibration. Possible bad EEPROM. Contact factory if problem persists.
E-88	<b>EEPROM Error</b>	All timer set-points are reset to 1 minute. Timers, if previously on, are now off. Possible bad EEPROM.
E-90	<b>Button stuck</b>	A button has been held down for > 60 seconds. Adjust control. Error will reset when the problem has been resolved.
E-91	<b>Input failure</b>	Contact factory.
E-dS	<b>Datakey error</b>	Datakey digital signature incompatible. Cycle power, and install compatible Datakey if error persists.
E-dT	<b>Datakey error</b>	Datakey incompatible with control. Install compatible Datakey.
E-dU	<b>Datakey unplugged</b>	Install Datakey and cycle power to control to clear error.
dLto	<b>Datalogger has timed out</b>	Cycle power. Contact factory if error persists.
dLSD	<b>Micro SD card not plugged in</b>	Plug in SD card and cycle power. Contact factory if error persists.

*Note: If in doubt, always cycle the power to the control and contact factory if the problem persists.*

### To test probe and air sensor:

Test probe and air sensor by placing sensor in ice water bath and using an ohmmeter set on the ohm scale. The reading should be 100 ohms resistance. If it is more than 2 ohms higher or lower, sensor needs to be replaced.

# SERVICE

## SERVICE VIEW - 1000-BQ2/192 Shown

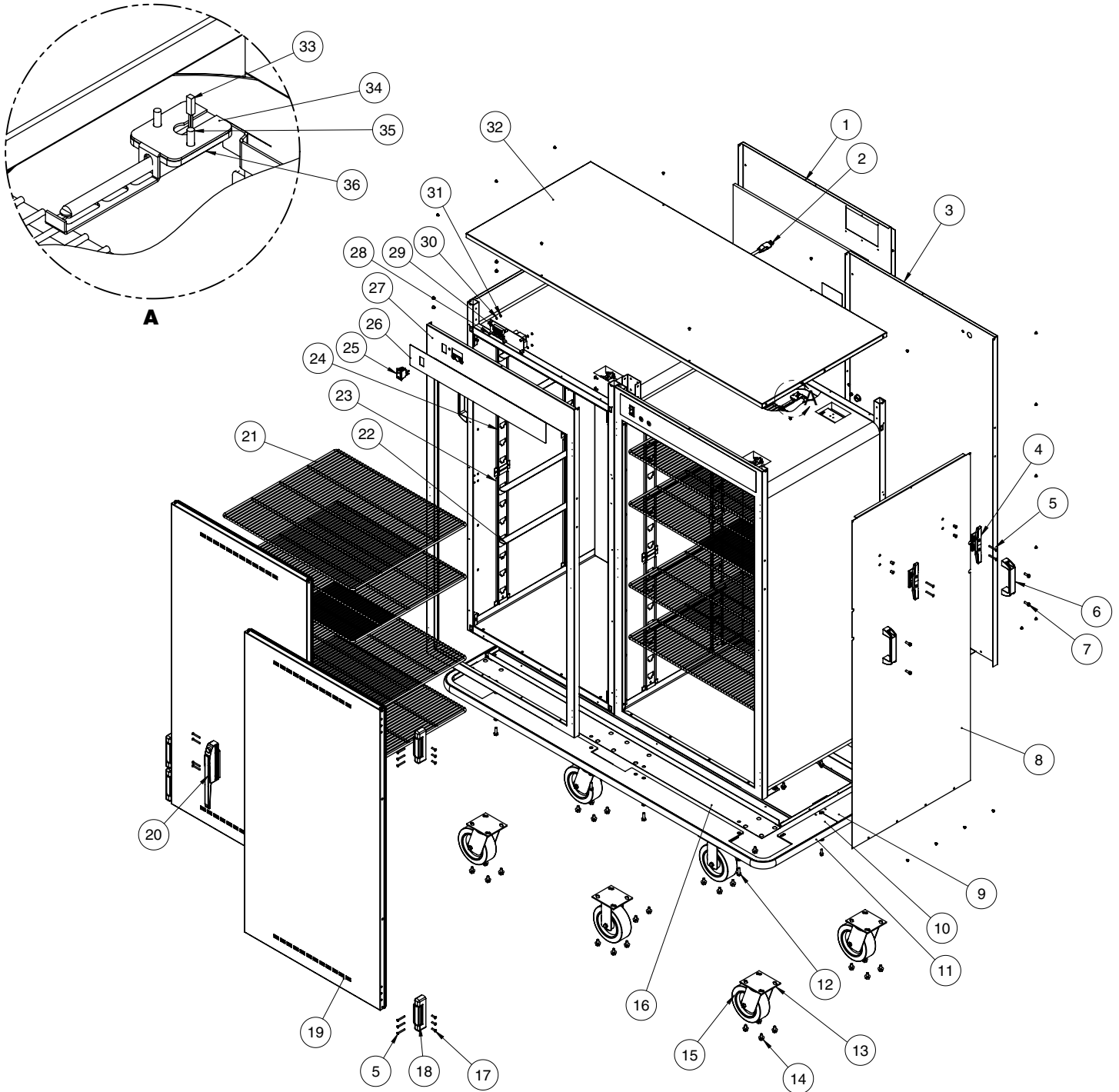

Part numbers and drawings are subject to change without notice.

# SERVICE

		MODEL >	1000-BQ2/96		1000-BQ2/128		1000-BQ2/192	
ITEM	DESCRIPTION	PART NO.	QTY	PART NO.	QTY	PART NO.	QTY	
1	BACK PANEL	—	—	—	—	1012121	1	
2	CORDSET	120V, 15 AMP CD-3232	1	—	—	—	—	
		120V, 20 AMP —	—	CD-3397	1	CD-3397	1	
		120V, 30 AMP —	—	—	—	CD-33366	1	
		230V (CEE 7/7) CD-3922	1	CD-3922	1	CD-3922	1	
		230V (CH2-16P) CD-36231	1	CD-36231	1	CD-36231	1	
		230V (BS 1363) CD-33925	1	CD-33925	1	CD-33925	1	
		208-240V CD-3551	1	CD-3551	1	CD-3551	1	
3	CASING BACK	1012107	1	1012145	1	1012107	1	
4	HANGER 6-1/2" ROPE CLEAT 7/16 BLACK NYLON	E2097HR	2	E2097HR	2	E2097HR	2	
5	SCREW, 10-32 X 1-1/2, NF, PHIL, FLAT M/S, 18-8 S/S	SC-35259	14	SC-35259	14	SC-35259	24	
6	HANDLE, TRANSPORT	HD-26792	1	HD-26792	1	HD-26792	4	
7	SCREW, 1/4-20 X 3/4" SHCS PCN	SC-22339	8	SC-22339	8	SC-22339	8	
8	SIDE PANEL	1012106	2	1012106	2	1012106	2	
9	REAR BUMPER	—	—	—	—	BM-27494	1	
10	FRONT BUMPER	—	—	—	—	BM-27495	1	
11	BUMPER, PERIMETER, RUBBER	BM-24766	11	BM-24766	12	BM-24766	16	
12	SCREW, M8 X 1.25 X 30mm HEX	SC-22279	4	SC-22279	4	SC-22279	8	
13	CASTER, SWIVEL, 6" (152mm)	CS-2231	2	CS-2231	2	CS-2231	4	
14	SCREW, 5/16-18 X 7/8" SERR. HEX HD	SC-22274	16	SC-22274	16	SC-22274	28	
15	CASTER, RIGID, 6" (152mm)	CS-2042	2	CS-2042	2	CS-2042	2	
16	BOTTOM PANEL SPOT ASSEMBLY	5013362	1	5013461	1	5013362	1	
17	SCREW, M5 X 0.8 X 30mm FLAT	SC-22853	6	SC-22853	6	SC-22853	12	
18	HINGE, 1-3/8" OFFSET, PAIR, CHROME	HG-22338	1	HG-22338	1	HG-22338	2	
*	HINGE COVER	CV-22171	2	CV-22171	2	CV-22171	4	
19	DOOR ASSEMBLY, FULL DOOR	RIGHT-HAND 5013419	2	5016927	2	5013451	4	
*		LEFT-HAND 5013420	2	5016928	2	5013451	4	
20	HANDLE, OFFSET MAG LATCH	HD-2566	1	HD-2566	1	HD-2566	2	
21	SHELF, NICKEL CHROME	SH-2835	4	SH-22727	4	SH-2835	8	
22	SHELF SLIDE	1061	8	1061	8	1061	16	
23	BOTTOM CLIP SUPPORT	1012309	5	1012309	5	1012309	10	
24	TOP CLIP SUPPORT	1012308	5	1012308	5	1012308	10	
25	SWITCH, ROCKER, 125-277V, 20A	SW-34769	1	SW-34769	1	SW-34769	2	
26	PANEL, OVERLAY, SIMPLE CONTROL BQ	PE-29511	1	PE-29511	1	PE-29511	2	
27	FRONT TRIM ASSEMBLY	5013358	1	5013403	1	5013358	2	
28	SPACER, SNAP-IN, 7/16"	SP-29392	6	SP-29392	6	SP-29392	12	
29	CONTROL	CC-34970	1	CC-34970	1	CC-34970	2	
30	WASHER, 6-32, FLAT, NYL	WS-23148	4	WS-23148	4	WS-23148	8	
31	NUT, 6-32 HEX, S/S	NU-2361	4	NU-2361	4	NU-2361	8	
32	TOP COVER	1012109	1	1012144	1	1012122	1	
33	PROBE	PR-34494	1	PR-34494	1	PR-34494	2	
34	BRACKET, SENSOR MTG.	1008272	1	1008272	1	1008272	2	
35	SCREW, 6-32 X 1/2", NC PHIL, FLAT	SC-2254	2	SC-2254	2	SC-2254	4	
36	SENSOR MOUNTING BLOCK	BK-29606	1	BK-29606	1	BK-29606	2	
37*	SHELF CLIP	11533	4	11533	4	11533	8	
38*	BRACKET SUPPORT BOTTOM CLIP	1015195	5	1015195	5	1015195	10	
39*	FRAME BRACKET	—	—	—	—	1012120	2	
40*	T-BLOCK	BK-3019	1	BK-3019	1	BK-3019	1	
41*	BUMPER, ALUMINUM FRAME	BM-28029	1	BM-28030	1	—	—	
42*	BUSHING, STRAIGHT, STRAIN RELIEF	BU-3964	1	BU-3964	1	BU-3964	1	
43*	CONNECTOR, #14 FERRULE	CR-34829	3	CR-34829	3	CR-34829	3	
44*	HINGE, 10-32 THREADED INSERT	HG-22672	4	HG-22672	4	HG-22672	4	
45*	RIVET, BLIND, #44, STNLS	RI-2100	28	RI-2100	28	RI-2100	68	
46*	SCREW, M4 X 0.7 X 6mm PHIL	SC-22271	4	SC-22271	31	SC-22271	42	
47*	SCREW, M4 X 0.7 X 10mm	SC-22273	3	SC-22273	3	SC-22273	4	
48*	SCREW, M8 X 1.25 X 30mm HEX	SC-22279	20	SC-22279	20	SC-22279	36	
49*	SCREW, M6 X 1.0 X 16mm HEX	SC-22284	6	SC-22284	6	SC-22284	6	
50*	SCREW, M5 X 0.8 X 10mm PAN	SC-22766	1	SC-22766	1	SC-22766	9	
51*	WASHER, 5/16" FLAT	WS-23725	6	WS-23725	6	WS-23725	10	
52*	WASHER, STAR LOCK	WS-2467	1	WS-2467	1	WS-2467	1	
53*	WASHER, LOCK, 5/16" DIA.	WS-2867	6	WS-2867	6	WS-2867	10	

\*NOT SHOWN

# SERVICE

## SPLIT DOOR (FACTORY INSTALLED OPTION) - 1000-BQ2/192 Doors Shown

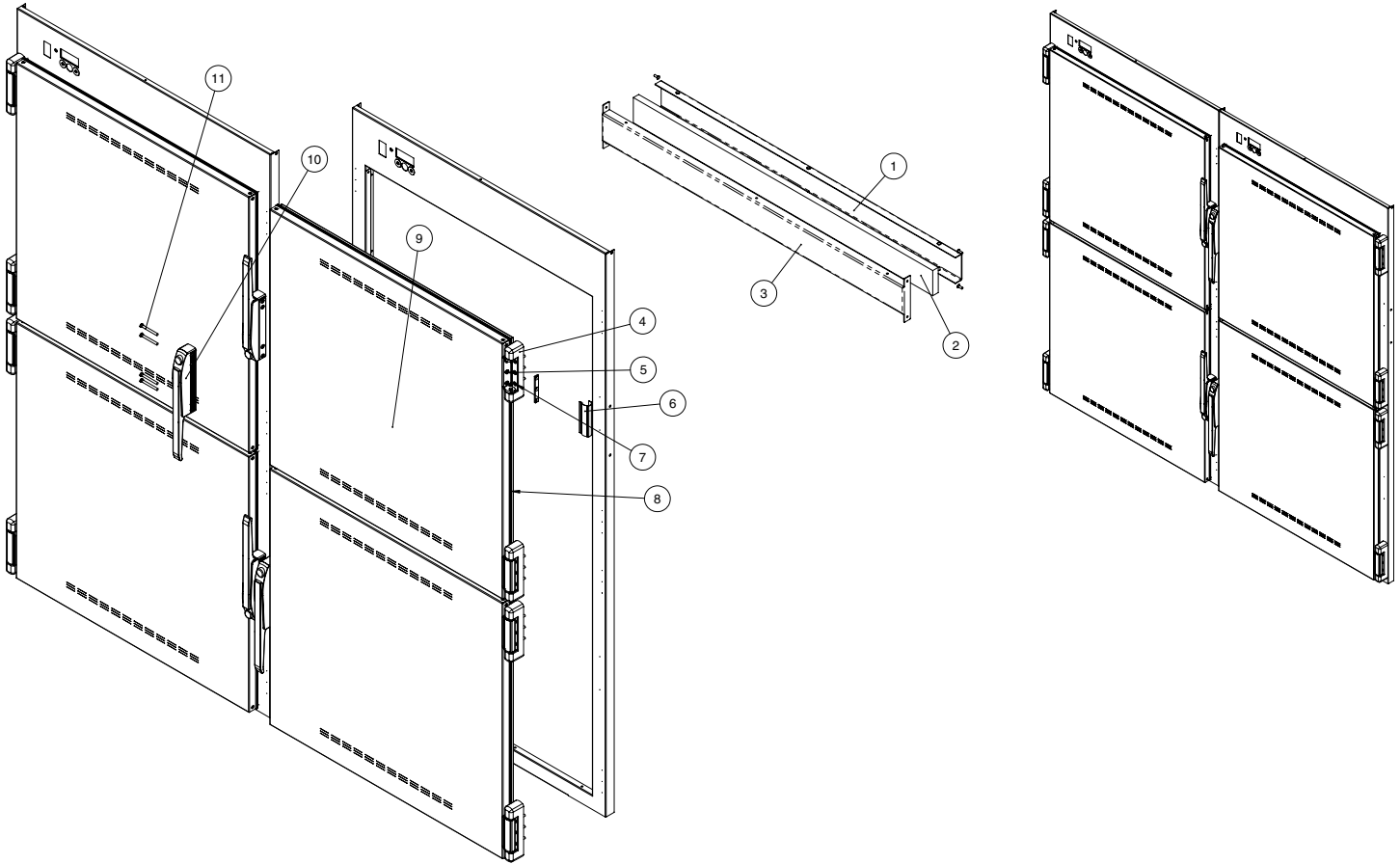

Part numbers and drawings are subject to change without notice.

MODEL >		1000-BQ2/96		1000-BQ2/128		1000-BQ2/192	
ITEM	DESCRIPTION	PART NO.	QTY	PART NO.	QTY	PART NO.	QTY
1	FRONT TRIM, INSIDE MULLION	1015133	1	1015133	1	1015133	2
2	INSULATION	IN-2003	1	IN-2003	1	IN-2003	2
3	FRONT TRIM, OUTSIDE MULLION	1015134	1	1015134	1	1015134	2
4	HINGE, 1-3/8" OFFSET, PAIR, CHROME	HG-22338	2	HG-22338	2	HG-22338	8
5	SCREW, M5 X 0.8 X 20mm FLAT	SC-23868	24	SC-23868	24	SC-23868	24
6	HINGE COVER	CV-22171	4	CV-22171	4	CV-22171	8
7	SCREW, M5 X 0.8 X 30mm FLAT	SC-22853	12	SC-22853	12	SC-22853	24
8	DOOR GASKET	GS-36249	2	GS-36249	2	GS-36249	4
9	DOOR ASSEMBLY	5016854	2	5016854	2	5016854	4
10	HANDLE, OFFSET MAG LATCH	HD-2566	2	HD-2566	2	HD-2566	4
11	SCREW, M5 X 0.8 X 50mm FLAT	SC-35259	20	SC-35259	20	SC-35259	16

# SERVICE

## SERVICE PARTS LIST

### TRAILER HITCH (FACTORY INSTALLED OPTION) - 1000-BQ2/96 Shown

#### TRAILER HITCH SAFETY

- No more than (3) carts are to be attached to either a dedicated "golf cart" or bicycle.
- Speed limits should be kept to a maximum of 5 mph (8km/h) to avoid potential employee injury.
- All food being transported should be in pans (covered), including; 2" deep, 4" deep and sheet pans. Adequate shelving and interior support structure is required to both maximize capacity as well as provide stable transportation and ease of access to loading/unloading of food products.

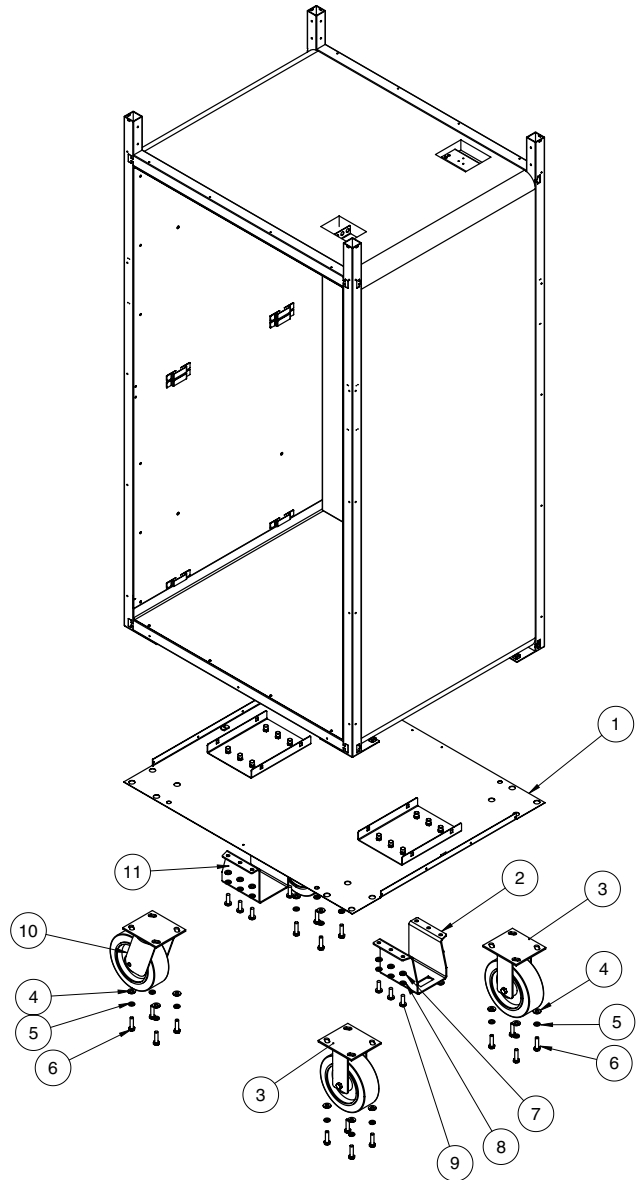

Part numbers and drawings are subject to change without notice.

		MODEL >		1000-BQ2/96		1000-BQ2/128		1000-BQ2/192	
ITEM	DESCRIPTION	PART NO.	QTY	PART NO.	QTY	PART NO.	QTY		
1	BOTTOM PANEL SPOT W/HITCH	5015721	1	5015983	1	5015985	1		
2	HITCH RECEIVER BRACKET W/SLOT	1013824	1	1013824	1	1013824	1		
3	CASTER, RIGID, 6" (152mm)	CS-2042	2	CS-2042	2	CS-2042	2		
4	WASHER, 5/16" FLAT	WS-23725	16	WS-23725	16	WS-23725	24		
5	WASHER, LOCK, 5/16 DIA.	WS-2867	16	WS-2867	16	WS-2867	24		
6	SCREW, M8 X 1.25 X 30mm HEX	SC-22279	16	SC-22279	16	SC-22279	24		
7	WASHER, M8, 18-8	WS-22298	12	WS-22298	12	WS-22298	12		
8	WASHER, M8 SPLIT LOCK	WS-22303	12	WS-22303	12	WS-22303	12		
9	SCREW, M8 X 1.25 X 25mm PAN	SC-26604	12	SC-26604	12	SC-26604	12		
10	CASTER, SWIVEL, 6" (152mm)	CS-2231	2	CS-2231	2	CS-2231	4		
11	HITCH PIN RECEIVER BRACKET	1013823	1	1013823	1	1013823	1		

# SERVICE

## Cable Heating Replacement Service Kit No. 4880

1000-BQ2/96 (125V) requires one (1) kit (129' of cable)

1000-BQ2/192 (125V) requires one (1) kit for one (1) cavity or two (2) kits for both cavities (129' of cable per cavity)

### Service kit includes:

CB-3045	Cable Heating Element.....	134 feet
CR-3226	Ring Connector.....	4
IN-3488	Insulation Corner.....	1 foot
BU-3105	Shoulder Bushing.....	12
BU-3106	Cup Bushing.....	4
SL-3063	Insulating Sleeve.....	4
TA-3540	High Temperature Electrical Tape.....	1 roll
ST-2439	10.32 Stud.....	4
NU-2215	Hex Nut.....	8

## Cable Heating Replacement Service Kit No. 4881

1000-BQ2/96 (208-240V) requires one (1) kit (204' of cable)

1000-BQ2/128 (120V) requires two (2) kits (360' of cable)

1000-BQ2/192 (208-240V) requires one (1) kit for one (1) cavity or two (2) kits for both cavities (204' of cable per cavity)

### Service kit includes:

CB-3045	Cable Heating Element.....	210 feet
CR-3226	Ring Connector.....	12
IN-3488	Insulation Corner.....	1 foot
BU-3105	Shoulder Bushing.....	12
BU-3106	Cup Bushing.....	12
SL-3063	Insulating Sleeve.....	12
TA-3540	High Temperature Electrical Tape.....	1 roll
ST-2439	10.32 Stud.....	12
NU-2215	Hex Nut.....	24

## Cable Heating Replacement Service Kit No. 4879

1000-BQ2/128 (208-240V) requires one (1) kit (120' of cable)

### Service kit includes:

CB-3045	Cable Heating Element.....	112 feet
CR-3226	Ring Connector.....	6
IN-3488	Insulation Corner.....	1 foot
BU-3105	Shoulder Bushing.....	6
BU-3106	Cup Bushing.....	6
SL-3063	Insulating Sleeve.....	6
TA-3540	High Temperature Electrical Tape.....	1 roll
ST-2439	Stud 10.32.....	6
NU-2215	Hex Nut.....	12

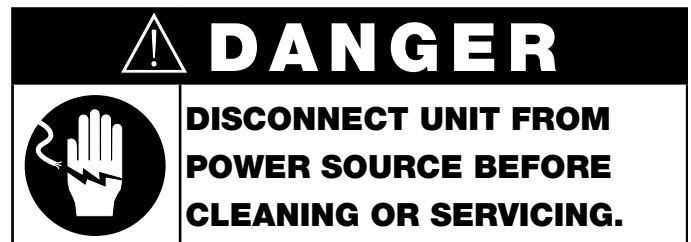

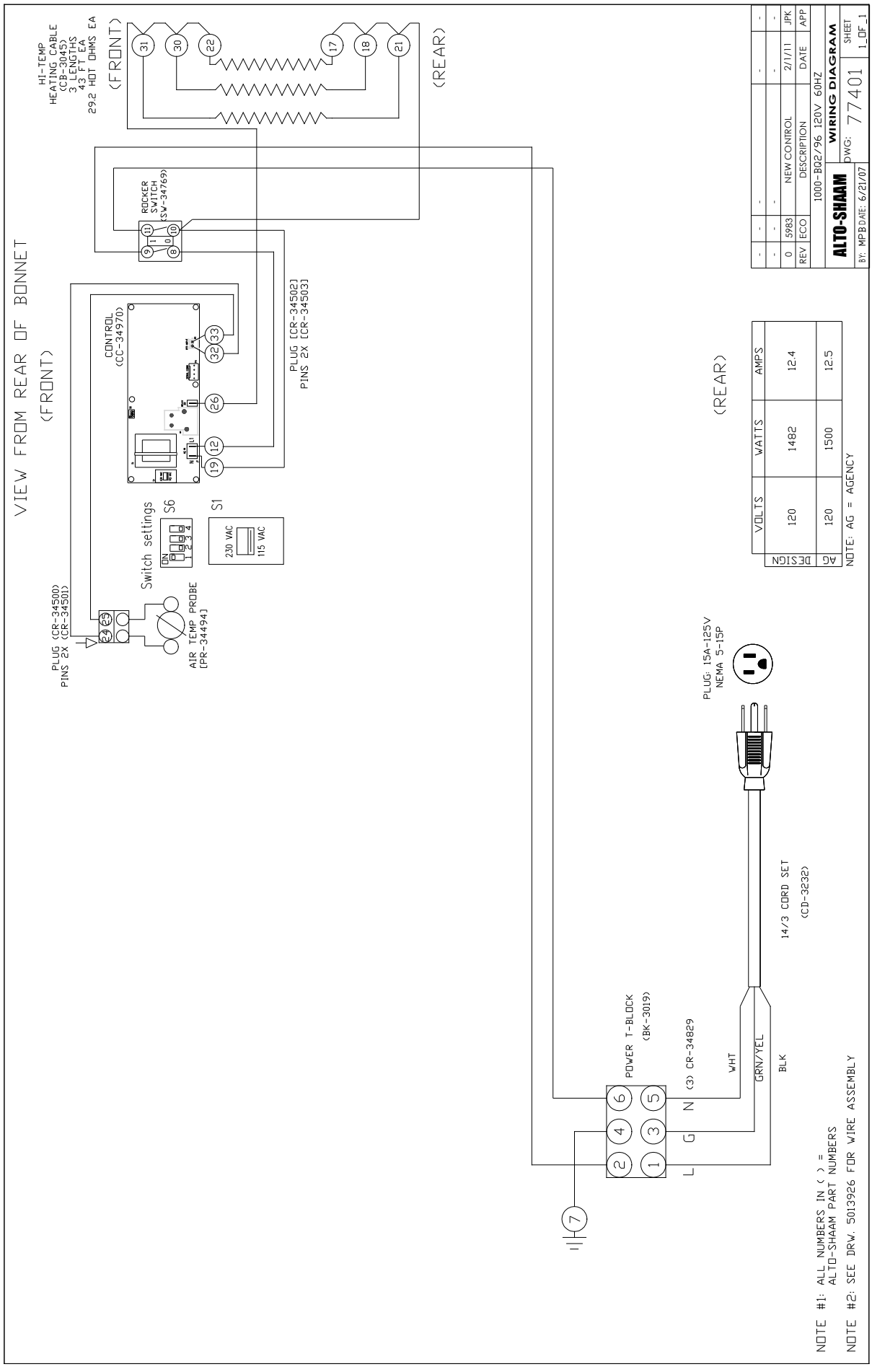

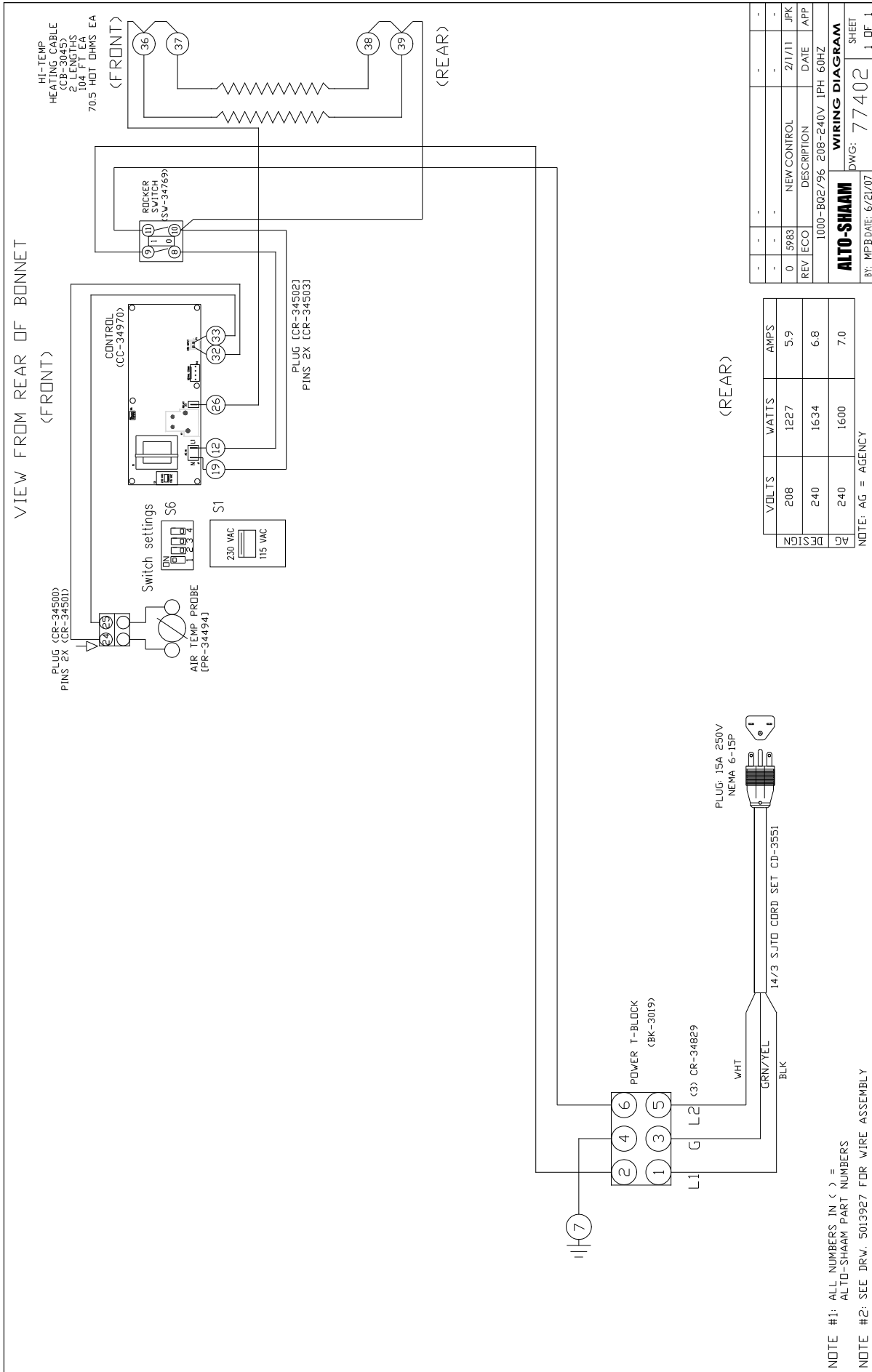





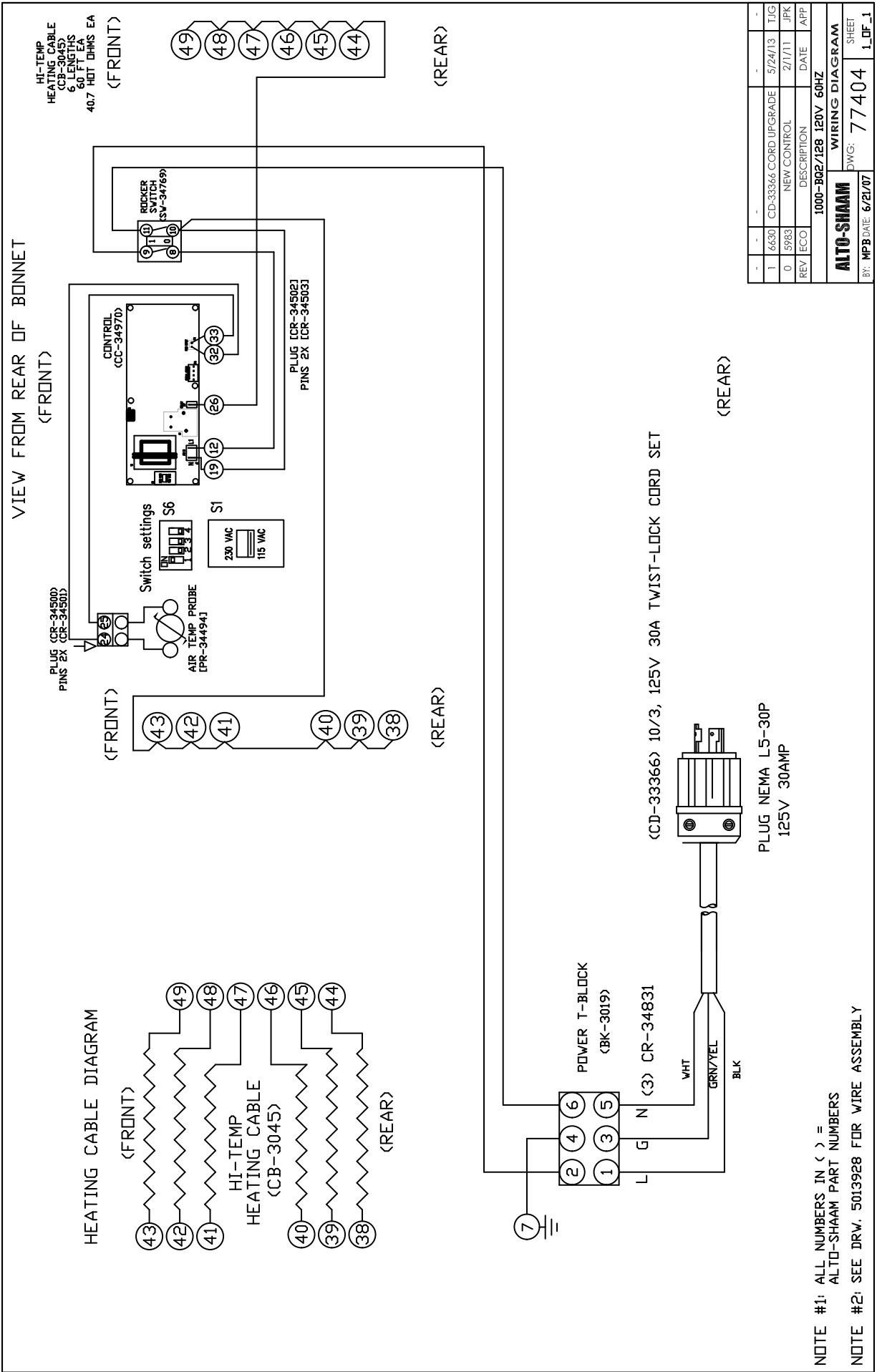

1	6630	CD-33366	CORD UPGRADE	5/24/13	TJG
0	5983		NEW CONTROL	2/1/11	JPK
REV	ECO		DESCRIPTION	DATE	APP
1000-BQ2/128 120V 60HZ					
<b>ALTO-SHAAM</b>					
				DWG:	77404
				BY: MPB	DATE: 6/21/07
					SHEET
					1_DF_1

NOTE #1: ALL NUMBERS IN ( ) = ALTO-SHAAM PART NUMBERS

NOTE #2: SEE DRW. 5013928 FOR WIRE ASSEMBLY





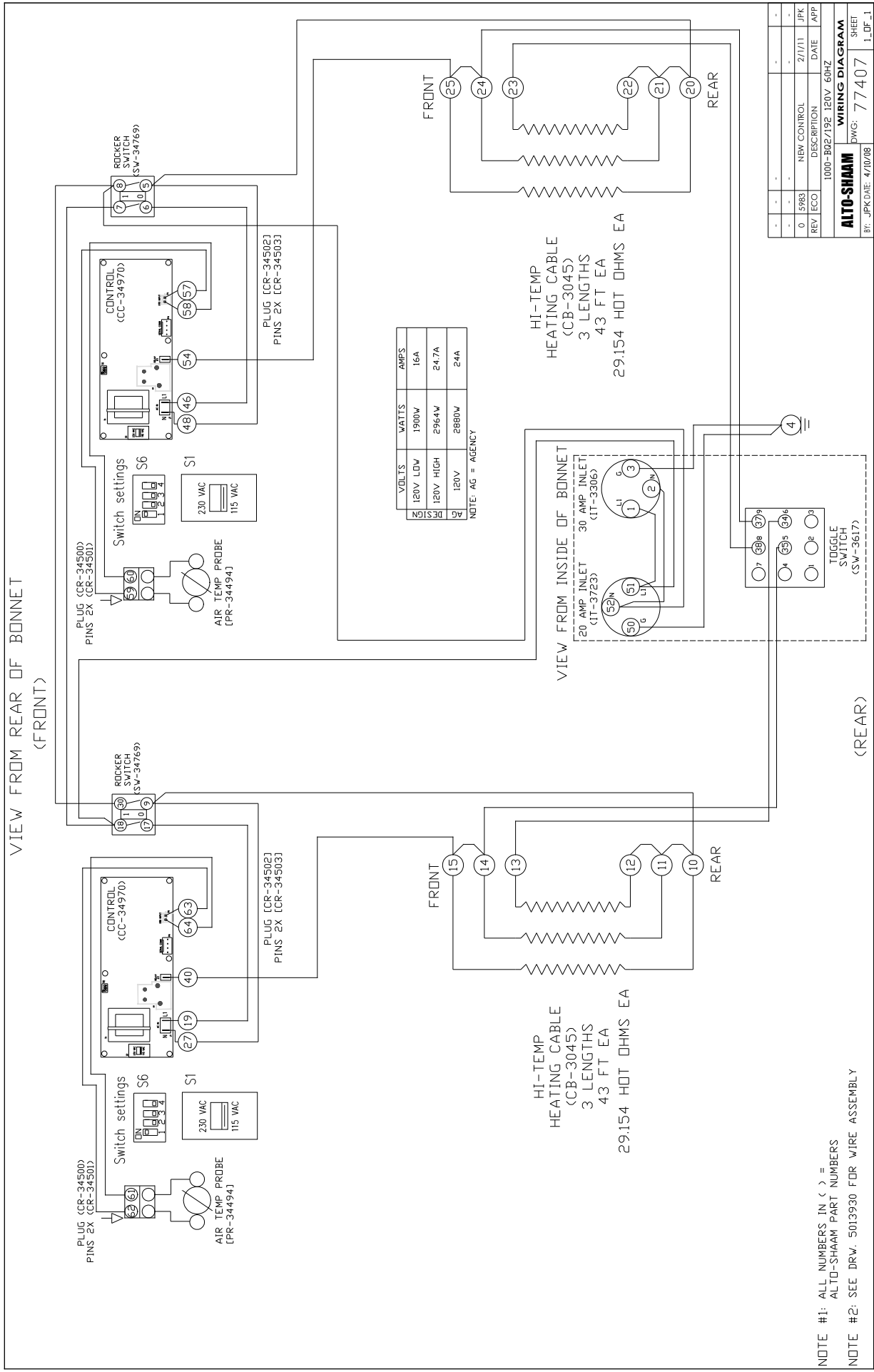

NOTE #1: ALL NUMBERS IN ( ) = ALTO-SHAAM PART NUMBERS  
 NOTE #2: SEE DRW. 5013930 FOR WIRE ASSEMBLY

REV	ECO	DESCRIPTION	DATE	APP
0	5983	NEW CONTROL	2/1/11	JPK
1000-BQ2/192		120V 60HZ		

**ALTO-SHAAM** WIRING DIAGRAM  
 BY: JPK/DME - 4/10/08 DWG: 77407 SHEET 1\_OF\_1

VIEW FROM REAR OF BONNET  
(FRONT)

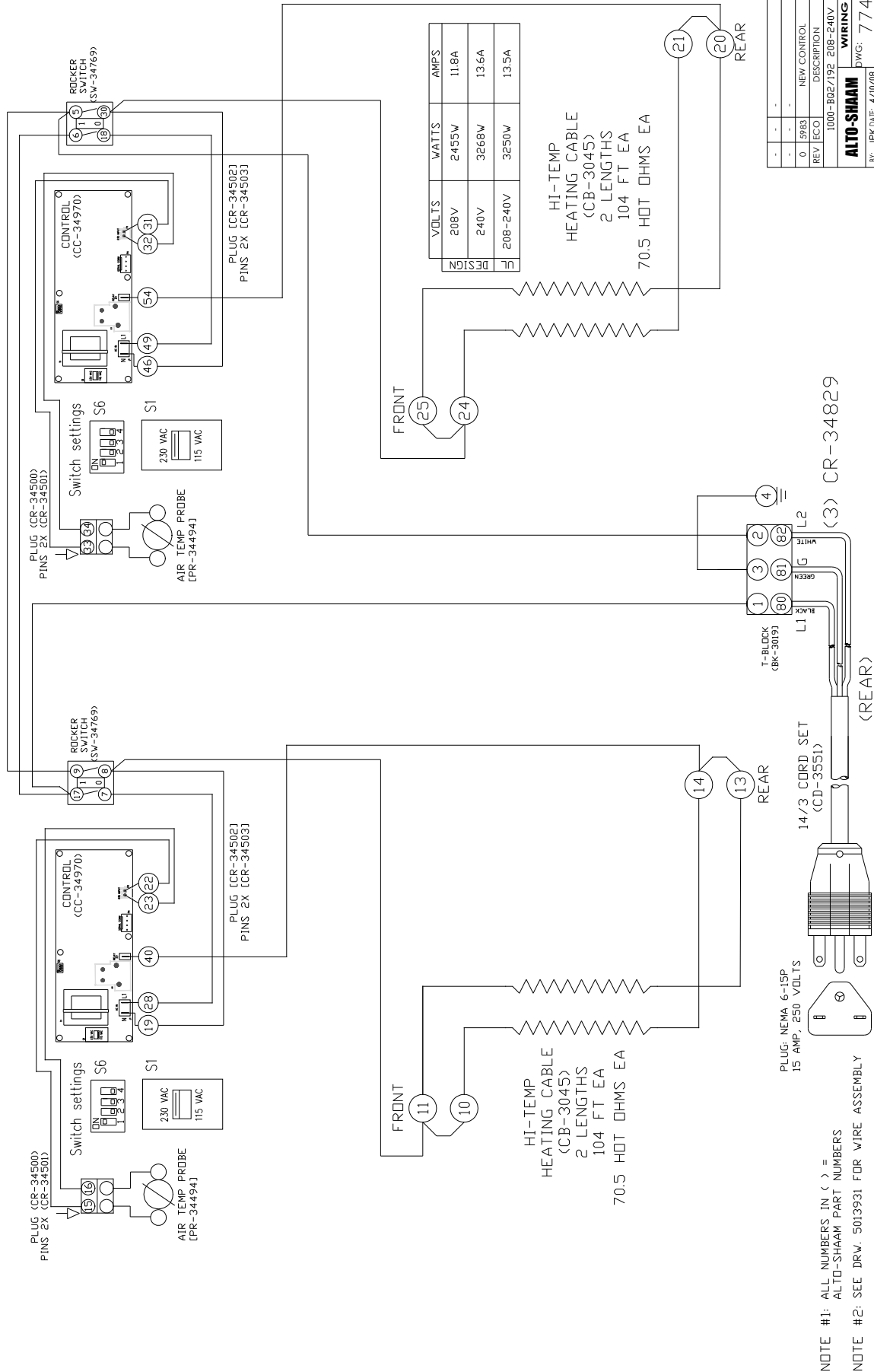

NOTE #1: ALL NUMBERS IN ( ) = ALTO-SHAAM PART NUMBERS  
NOTE #2: SEE DRW. 5013931 FOR WIRE ASSEMBLY

REV	ECO	DESCRIPTION	DATE	APP
0	5983	NEW CONTROL	2/1/11	JFK
1000-BQ2/192		208-240V 1PH 60HZ		

**ALTO-SHAAM**  
WIRING DIAGRAM  
BY: JFK DATE: 4/10/08 DWG: 77408 SHEET 1\_DF-1

VIEW FROM REAR OF BONNET  
(FRONT)

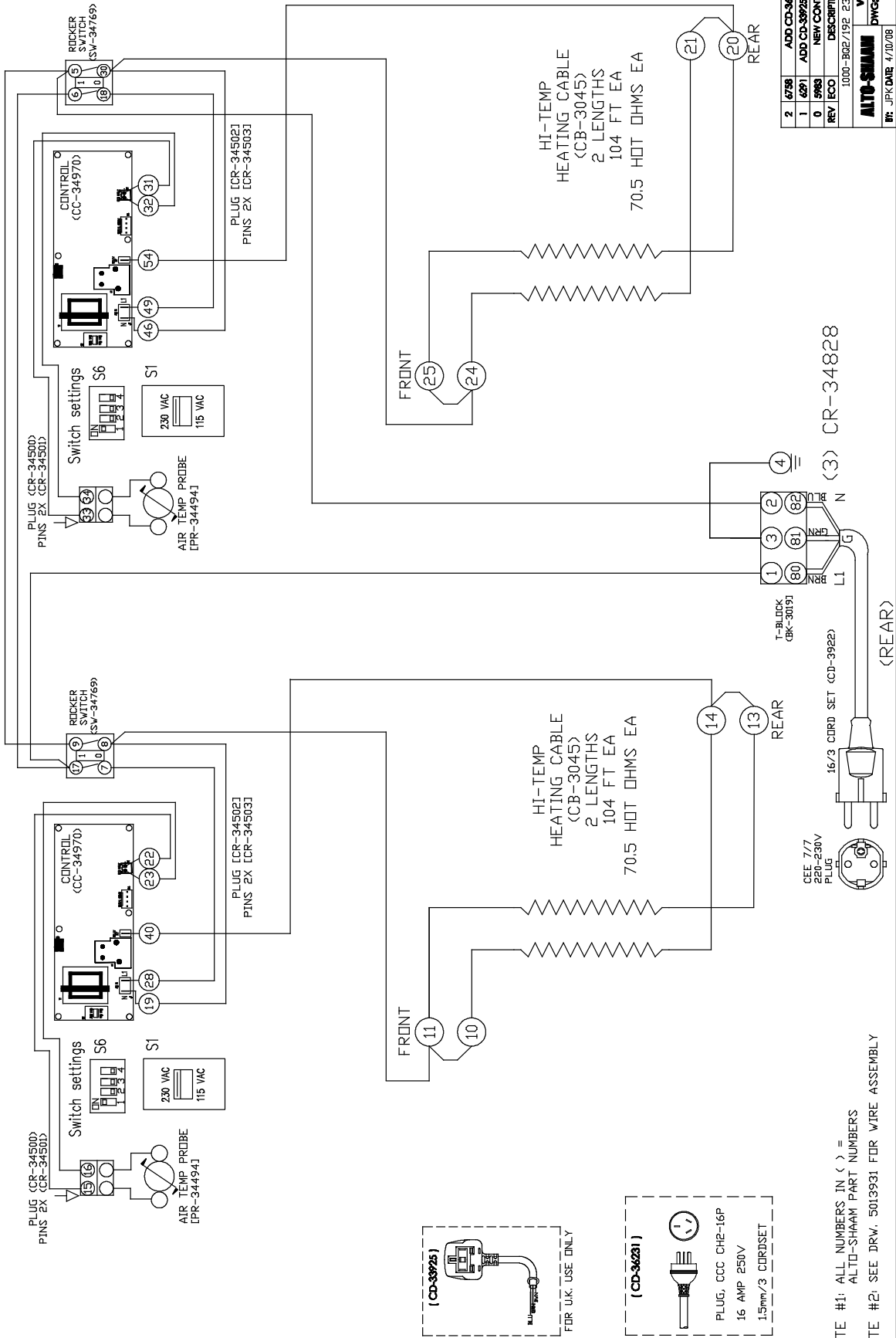

REV	ECO	DESCRIPTION	DATE	APP
2	6758	ADD CD-36231	09/20/14	T/JG
1	6591	ADD CD-3925 FOR UK	3/13/12	NVA
0	5988	NEW CONTROL	2/1/11	JPK
1000-962/192				

1000-962/192 230V 1PH 50/60HZ

**ALTO-SHAAM** WIRING DIAGRAM  
 PFC: JPK/DAB 4/10/08 DWG: 77409 SHEET 1\_DF\_1

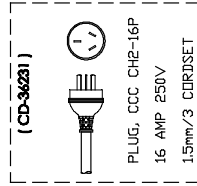
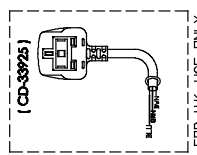

NOTE #1: ALL NUMBERS IN ( ) = ALTO-SHAAM PART NUMBERS  
 NOTE #2: SEE DRW. 5013931 FOR WIRE ASSEMBLY

# TRANSPORTATION DAMAGE and CLAIMS



All Alto-Shaam equipment is sold F.O.B. shipping point, and when accepted by the carrier, such shipments become the property of the consignee.

Should damage occur in shipment, it is a matter between the carrier and the consignee. In such cases, the carrier is assumed to be responsible for the safe delivery of the merchandise, unless negligence can be established on the part of the shipper.

1. Make an immediate inspection while the equipment is still in the truck or immediately after it is moved to the receiving area. Do not wait until after the material is moved to a storage area.
2. Do not sign a delivery receipt or a freight bill until you have made a proper count and inspection of all merchandise received.
3. Note all damage to packages directly on the carrier's delivery receipt.
4. Make certain the driver signs this receipt. If he refuses to sign, make a notation of this refusal on the receipt.
5. If the driver refuses to allow inspection, write the following on the delivery receipt:  
*Driver refuses to allow inspection of containers for visible damage.*
6. Telephone the carrier's office immediately upon finding damage, and request an inspection. Mail a written confirmation of the time, date, and the person called.
7. Save any packages and packing material for further inspection by the carrier.
8. Promptly file a written claim with the carrier and attach copies of all supporting paperwork.

We will continue our policy of assisting our customers in collecting claims which have been properly filed and actively pursued. We cannot, however, file any damage claims for you, assume the responsibility of any claims, or accept deductions in payment for such claims.

## LIMITED WARRANTY

Alto-Shaam, Inc. warrants to the original purchaser only that any original part that is found to be defective in material or workmanship will, at Alto-Shaam's option, subject to provisions hereinafter stated, be replaced with a new or rebuilt part.

### The original parts warranty period is as follows:

For the refrigeration compressor on Alto-Shaam Quickchillers™, five (5) years from the date of installation of appliance.

For the heating element on Halo Heat® cooking and holding ovens, as long as the original purchaser owns the oven. This excludes holding only equipment.

For all other original parts, one (1) year from the date of installation of appliance or fifteen (15) months from the shipping date, whichever occurs first.

The labor warranty period is one (1) year from the date of installation or fifteen (15) months from the shipping date, whichever occurs first.

Alto-Shaam will bear normal labor charges performed during standard business hours, excluding overtime, holiday rates or any additional fees.

To be valid, a warranty claim must be asserted during the applicable warranty period. This warranty is not transferable.

### THIS WARRANTY DOES NOT APPLY TO:

1. Calibration.
2. Replacement of light bulbs, door gaskets, and/or the replacement of glass due to damage of any kind.
3. Equipment damage caused by accident, shipping, improper installation or alteration.
4. Equipment used under conditions of abuse, misuse, carelessness or abnormal conditions, including but not limited to, equipment subjected to harsh or inappropriate chemicals, including but not limited to, compounds containing chloride or quaternary salts, poor water quality, or equipment with missing or altered serial numbers.
5. Damage incurred as a direct result of poor water quality, inadequate maintenance of steam generators and/or surfaces affected by water quality. Water quality and required maintenance of steam generating equipment is the responsibility of the owner/operator.
6. Damage caused by use of any cleaning agent other than Alto-Shaam's Combitherm® Cleaner, including but not limited to damage due to chlorine or other harmful chemicals. **Use of Alto-Shaam's Combitherm® Cleaner on Combitherm® ovens is highly recommended.**
7. Any losses or damage resulting from malfunction, including loss of product, food product, revenue, or consequential or incidental damages of any kind.
8. Equipment modified in any manner from original model, substitution of parts other than factory authorized parts, removal of any parts including legs, or addition of any parts.

This warranty is exclusive and is in lieu of all other warranties, express or implied, including the implied warranties of merchantability and fitness for a particular purpose. In no event shall Alto-Shaam be liable for loss of use, loss of revenue or profit, or loss of product, or for any indirect, special, incidental, or consequential damages. No person except an officer of Alto-Shaam, Inc. is authorized to modify this warranty or to incur on behalf of Alto-Shaam any other obligation or liability in connection with Alto-Shaam equipment.



Effective November 1, 2012

RECORD THE MODEL AND SERIAL NUMBER OF THE APPLIANCE FOR EASY REFERENCE.  
ALWAYS REFER TO BOTH MODEL AND SERIAL NUMBER IN ANY CONTACT WITH ALTO-SHAAM REGARDING THIS APPLIANCE.

Model: \_\_\_\_\_ Date Installed: \_\_\_\_\_  
Voltage: \_\_\_\_\_ Purchased From: \_\_\_\_\_  
Serial Number: \_\_\_\_\_

W164 N9221 Water Street • P.O. Box 450 • Menomonee Falls, Wisconsin 53052-0450 • U.S.A.

PHONE: 262.251.3800 • 800.558-8744 USA/CANADA FAX: 262.251.7067 • 800.329.8744 U.S.A. ONLY

www.alto-shaam.com

PRINTED IN U.S.A.