

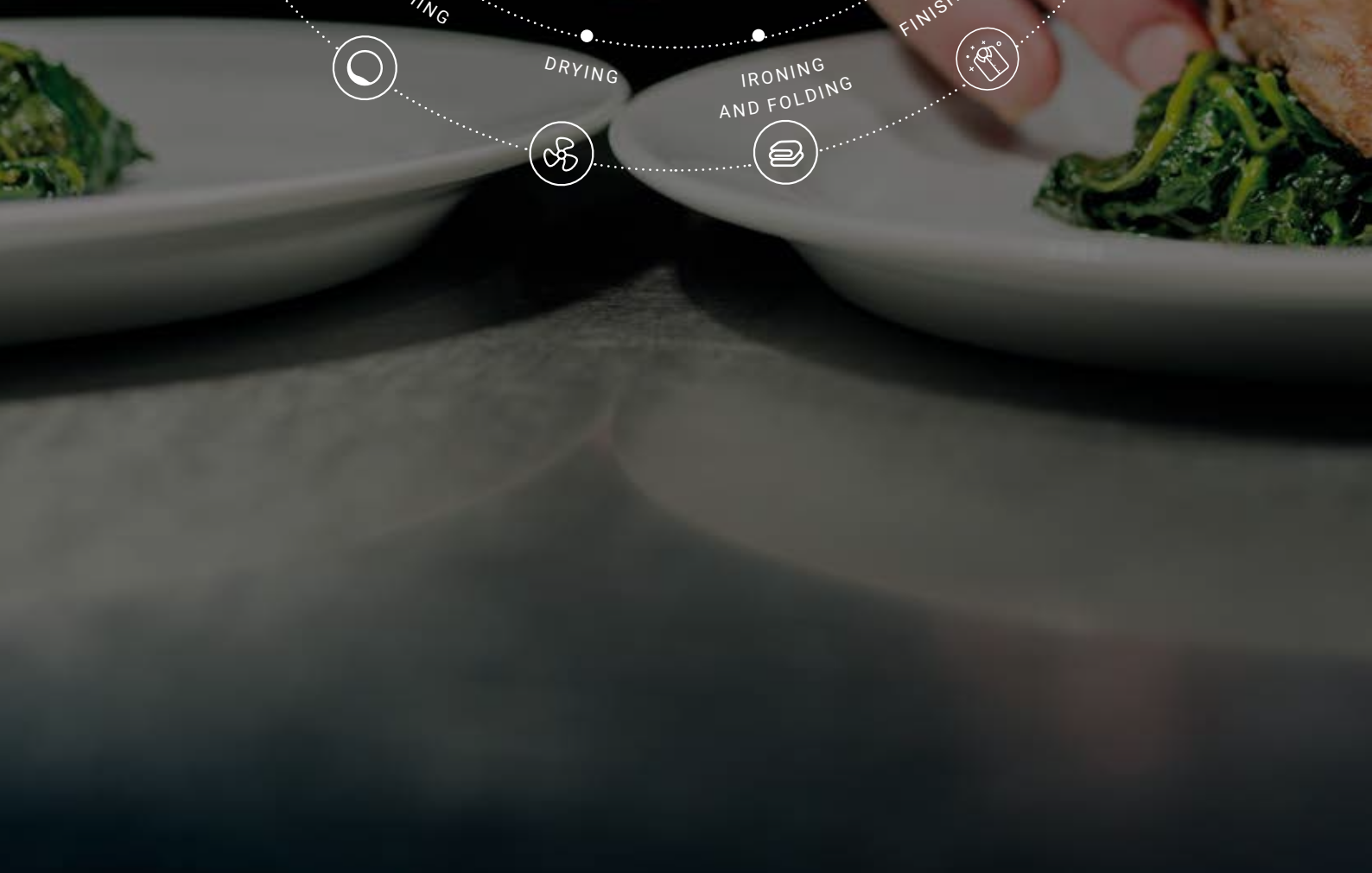

Foodservice

Index

Cooking	07
— Symphony.....	09
— Kore 900.....	11
— Kore 700.....	45
— 600 Series.....	79
— Large capacity cooking equipment.....	91
— Independent cooking.....	111
Ovens	121
— Ovens.....	124
— Cook & Chill.....	134
— Accessories.....	145
Commercial refrigeration	159
— Refrigerated cabinets.....	161
— Refrigerated Counters.....	187
— Preparation counters.....	217
— Bottle coolers.....	231
— Showcases.....	251
— Blast chillers.....	257
— Ice makers.....	269
Distribution	281
— Drop-in.....	285
— Self-service.....	305
— Wine cellars and dry ager cabinets.....	327
— Trolleys and counters for distribution.....	337
Dishwashing	343
— Glasswasher.....	347
— Front loading dishwashers.....	355
— Hood-type dishwashers.....	365
— Utensilwashers.....	377
— Rack conveyor.....	381
— Flight type dishwashers.....	399
— Dishwashing baskets.....	407
Annexes	413





60 years at your side.

We're the leading manufacturer in equipment for hospitality, foodservice and laundry. We're leaders because we have over 60 years of experience in offering a comprehensive range of products all under the same brand. But, above all, we're leaders because of you.

You've driven our technological innovations with your professional challenges.
You've spurred us on with your requirements and your trust.
You've accompanied us this far, and you will accompany us in the future, because cooperating with you is the best way to keep evolving. Because being close to you is the guarantee that we'll go far.
Distributor, professional and worker. You are the energy that drives the Fagor Industrial machine.

You make this make sense.

**You make
it happen**



- Sales delegations
- Own-manufacture plants



A global brand, close to you, wherever you are.

Our 35 offices distributed around the world, the professionalism of our 2,200 workers and our international experience help us to always remain close to you, to your needs, to your projects. But, above all, our implication, our commitment to service and our way of directly interacting with those around us, from professional to professional, means that we use the same language when responding to your challenges with the proximity of a major brand.

Wherever you are.





Cooking



**According
to your needs.**



Find out more!



Access the website

Symphony

To solve and optimise available space, Symphony offers you the possibility to design and personalise your kitchen in complete freedom, based on your needs, combining the different elements, devices and accessories available.



KORE
GENERATION

**Performance and
productivity at full
power.**



Find out more!



Access the website



Comercial video



Sales brochure

900 Series

Gas cookers.....	013
Gas solid tops.....	015
Paella cookers.....	016
Electric cookers.....	017
Electric solid tops with 4 cooking zones.....	018
Induction cookers.....	019
Fry-tops.....	020
Grills.....	022
Pasta cookers.....	024
Boiling pans.....	025
Fryers.....	027
Chips scuttle.....	028
Tiling bratt pans.....	029
Bain marie.....	030
Neutral elements.....	031
Stands.....	032
Refrigerated stands.....	033
Kore 900 blocks and verticality.....	034
Accessories.....	043

All gas cooking equipment should be fitted with gas governors:
 LPG: 37 g/cm²
 Natural Gas: 20 g/cm²

Gas cookers



General characteristics

- Stamped surface tops, manufactured in 2 mm thick AISI-304 stainless steel.
- Laser-cut joints, automatic welding and polishes. Screws hidden from view.
- Hobs with dimensions 397 x 350 mm allowing the use of large pans and pots. The shortened distance between the central prongs, 75 mm, allows them to support pans with a very small diameter (8 cm). This also avoids the danger of small containers tipping over.
- The hobs are manufactured in RAAF enamelled cast iron (resistant to acid and alkali products, and to fire and high temperatures).
- Double crown burners and diffusers in nickel-plated cast iron, guaranteeing the even distribution of heat from the flame in the bottom of the pans, even large ones. This avoids the accumulation of heat at a single point and optimises the energy transfer of the product.
- Burners of different power ratings to adapt to the containers and their use with different foodstuffs:
 - 5,25 kW (Ø 100 mm),
 - 8,0 kW (Ø 120 mm)
 - 10,2 kW (Ø 140 mm).

- Burners slot back in with no way of confusing their position.
- Low consumption pilots and thermocouples positioned within the body of the burner for greater protection.
- Gas conduction in flexible stainless steel tubes, making internal manipulation easier and facilitating any repair work.
- Controls set on a protective base with a system against water infiltration.
- High temperature enamelled cast iron flue protector aligned with the hobs, facilitating manoeuvrability and supporting larger containers, increasing useful surface area.
- Access to the components from the front.





















OVEN

- Option to choose between a GN 2/1 static oven with dimensions of 1,000 x 700 x 290 mm (OP version cookers); or an electrical oven with GN 2/1 dimensions.
- User-friendly, with controls set on the upper panel for better ergonomics.
- Cooking chamber made entirely from stainless steel, making it easier to clean and ensuring a better level of hygiene.
- Tray inserted sideways, making it more user-friendly.
- Guide rails at three levels which offers different usage options.

- Guides rails with "U" shape to prevent the racks from tipping.
- Temperature controlled by thermostatic valve (125 – 310 °C).
- Heating:
 - Gas: Stainless steel tube burner (two branches in OP version), with pilot flame, thermocouple, and Piezo electric ignition.
 - Electric: Heating via stainless steel covered elements with selector switch to control the upper and/or lower zones.
- Oven floor made from 6 mm cast iron, which guarantees better performance and even heat distribution.
- Fibre glass closing seal that improves the thermal efficiency of the oven and guarantees durability.
- Detachable oven door which makes repairs easier.

OPTIONAL ACCESSORIES

- (see accessories page at end of chapter)
- Plate to place over 5,25 kW burners.
 - Water column.

	MODEL	GAS	CODE	GRILLS (mm)	BURNERS			OVENS		TOTAL POWER (KW)	DIMENSIONS (mm)	€
					5,25 KW	8,0 KW	10,2 KW	SIZE	POWER(KW)			
COUNTERTOP												
	 C-G920	LPG	19075525	397x350	1	1	-	-	-	13,25	400x930x290	-
		NG	19075526									
	 C-G920 H	LPG	19075521	397x350	-	1	1	-	-	18,20	400x930x290	-
		NG	19075523									
	 C-G920 XH	LPG	19085164	397x350	-	-	2	-	-	20,40	400x930x290	-
		NG	19085165									
	 C-G940	LPG	19075531	397x350	2	1	1	-	-	28,70	800x930x290	-
		NG	19075532									
	 C-G940 H	LPG	19075527	397x350	-	3	1	-	-	34,20	800x930x290	-
		NG	19075529									
	 C-G940 XH	LPG	19085166	397x350	-	-	4	-	-	40,80	800x930x290	-
		NG	19085167									
	 C-G960	LPG	19075543	397x350	3	2	1	-	-	41,95	1200x930x290	-
		NG	19075544									
	 C-G960 H	LPG	19075539	397x350	-	5	1	-	-	50,20	1200x930x290	-
		NG	19075541									
GN 2/1 STATIC GAS OVEN												
	 C-G941	LPG	19075537	397x350	2	1	1	GN-2/1	8,60	37,30	800x930x850	-
		NG	19075538									
	 C-G941 H	LPG	19075533	397x350	-	3	1	GN-2/1	8,60	42,80	800x930x850	-
		NG	19075535									
	 C-G941 XH	LPG	19085168	397x350	-	-	4	GN-2/1	8,60	49,40	800x930x850	-
		NG	19085169									
	 C-G961	LPG	19075549	397x350	3	2	1	GN-2/1	8,60	50,55	1200x930x850	-
		NG	19075550									
	 C-G961 H	LPG	19075545	397x350	-	5	1	GN-2/1	8,60	58,80	1200x930x850	-
		NG	19075547									
PANORAMIC STATIC GAS OVEN												
	 C-G961 OP	LPG	19075555	397x350	3	2	1	1.000x700x290	14,00	55,95	1200x930x850	-
		NG	19075556									
	 C-G961 OP H	LPG	19075551	397x350	-	5	1	1.000x700x290	14,00	64,20	1200x930x850	-
		NG	19075553									
GN 2/1 STATIC ELECTRIC OVEN												
	 C-GE941	LPG	19075559	397x350	2	1	1	GN-2/1	6,00	34,70	800x930x850	-
		NG	19075572									

MODELS: **H:** With high power burners. / **OP:** With panoramic oven.

Gas solid tops



General characteristics





- Stamped surface tops manufactured in 2 mm thick AISI-304 stainless steel.
- Laser-cut joints, automatic welding and polishes. Screws hidden from view.
- 10 mm thick cast iron plate with rounded corners. 300 mm diameter surface.
- Refractory brick with cast iron shield inside to take better advantage of the heat and distribute it better.
- Temperatures for differentiated use: 500 °C at the centre and 200 °C near the edges.
- Low consumption pilot and thermocouple.
- Gas conduction in flexible stainless steel tube, making internal manipulation easier and facilitating any repair work.
- Controls set on a protective base with system against water infiltration.

- High temperature enamelled cast iron flue protector aligned with the hobs, facilitating manoeuvrability and support of the containers, increasing the useful surface area.
- Access to the components from the front.

OVEN

- Easy to use static GN 2/1 size oven, with the controls positioned on the upper panel.
- Cooking chamber constructed entirely in stainless steel, making it easier to clean and providing better hygiene.
- Tray introduced sideways, making it easier to handle.

- Guides at three heights to offer different working options.
- Guides with "U" shape to prevent the trays from tipping.
- Temperature controlled by thermostatic valve (125 – 310 °C).
- Tubular stainless steel burner, with pilot and thermocouple, and piezoelectric ignition.
- Oven floor manufactured in 6 mm cast iron, guaranteeing better performance and even heat distribution.
- Fibreglass closing seal to improve the oven's thermal efficiency.

MODEL	GAS	CODE	SOLID TOP (mm)	OVEN			TOTAL POWER (KW)	DIMENSIONS (mm)	€
				BURNERS	DIMENSIONS	POWER (KW)			
SOLID TOP									
  C-G910	LPG	19075517	800x700	1	-	-	11,00	800x930x290	-
	NG	19075518							
SOLID TOP WITH OVEN									
  C-G911	LPG	19075519	800x700	1	GN-2/1	8,60	19,60	800x930x850	-
	NG	19075520							

Paella cookers





General characteristics

- Stamped surface tops manufactured in 2 mm thick AISI-304 stainless steel.
- Laser-cut joints, automatic welding and polishes. Screws hidden from view.
- Double crown burner with four rows of flames in each, guaranteeing the even distribution of heat from the flame to the bottom of the paella pan.
- Low consumption pilot and thermocouple.
- Gas conduction in flexible stainless steel tube, making internal manipulation easier and facilitating any repair work.
- Controls set on a protective base with system against water infiltration.
- High temperature enamelled cast iron flue protector aligned with the hobs, facilitating manoeuvrability and support of the containers, increasing the useful surface area.
- Access to the components from the front.
- Temperature controlled by thermostatic valve (125 – 350°C).
- Tubular stainless steel burner at the front; operates with temperature gradient. Pilot with piezoelectric ignition and thermocouple.
- Oven floor manufactured in stainless steel.
- Side opening double panel door.

PAELLA OVEN

- 665 x 665 x 325 mm static paella oven, with the controls located on the top panel.
- Cooking chamber constructed entirely in stainless steel, making it easier to clean and providing better hygiene.

MODEL	GAS CODE	BURNERS			OVEN		TOTAL POWER (KW)	DIMENSIONS (mm)	€	
		Ø OUTER CROWN (mm)	Ø INNER CROWN (mm)	POWER (KW)	SIZE	POWER (KW)				
BOILING TOP										
 C-GP910	LPG	19075573	450	330	27,00	-	-	27,00	800x930x290	-
	NG	19075574								
WITH OVEN										
 C-GP911	LPG	19075575	450	330	27,00	665x665x325	7,30	34,30	800x930x850	-
	NG	19075576								

Electric cookers



General characteristics

- Surface tops manufactured in 2 mm thick AISI-304 stainless steel, designed to prevent liquids spilt from the pans from penetrating into the cooker.

- Laser-cut joints, automatic welding and polishes. Screws hidden from view.

- Hot plates manufactured with 300 x 300 mm cast iron, with 4 kW of power, hermetically sealed into the stamped surface top.

- Power regulation by 7 position selector.

- Safety thermostat for each plate.

- Interior fan to lower the temperature of the components.

- Stamped surface with rounded corners for easy cleaning.

- High temperature enamelled cast iron flue protector.

- Access to the components from the front.

- Machines with IPX5 grade water protection.

OVEN

- Easy to use static GN 2/1 size oven with the controls positioned on the upper panel for better ergonomics.

- Cooking chamber constructed entirely in stainless steel, making it easier to clean and providing better hygiene.

- Tray introduced sideways for easier handling.

- Guides at three heights to offer different working options.

- Guides with "U" shape to prevent the trays from tipping.

- Thermostatic temperature control (125 – 310 °C).

- Heating by means of stainless steel shielded heating elements with selector switch to operate the upper and/or lower zone.

- Oven floor manufactured in 6 mm cast iron, guaranteeing better performance and even heat distribution.







- Fibreglass closing seal to improve the oven's thermal efficiency.

- Dismountable oven door to facilitate repair.

VOLTAGE:

- 400 V 3+N.

- Ask for other voltages.

	MODEL	CODE	PLATES		OVEN		TOTAL POWER (kW)	DIMENSIONS (mm)	€
			(mm)	4,0 kW	SIZE	POWER (kW)			
BOILING TOP									
	C-E920	19075501	300x300	2	-	-	8,00	400x930x290	-
	C-E940	19075505	300x300	4	-	-	16,00	800x930x290	-
	C-E960	19075513	300x300	6	-	-	24,00	1.200x930x290	-
WITH OVEN									
	C-E941	19075509	300x300	4	GN-2/1	6,00	22,00	800x930x850	-
	C-E961	19075514	300x300	6	GN-2/1	6,00	30,00	1.200x930x850	-
	C-E961 OP	19075516	300x300	6	1.000x700x290	12,00	36,00	1.200x930x850	-

OP MODELS: With large oven 1.000 x 700 x 290 mm.

Electric solid tops with 4 cooking zones



General characteristics

- Surface tops manufactured in 2 mm thick AISI-304 stainless steel, designed to prevent liquids spilled from the pans from penetrating into the cooker.
- Laser-cut joints, automatic welding and polishes. Screws hidden from view.
- "Solid-top" models with four heating elements beneath the 15 mm thick cast steel fry-top, distributed so as to heat the four quadrants of the fry-top independently.
- Power control for each heating element. This allows the user to work with different temperature gradients on the fry-top.- Interior fan to lower the temperature of the components.
- Stamped surface with rounded corners for easy cleaning.
- High temperature enamelled cast iron flue protector.



- Access to the components from the front.
- Machines with IPX5 grade water protection.

OVEN

- Easy to use static GN 2/1 size oven with the controls positioned on the upper panel for better ergonomics.
- Cooking chamber constructed entirely in stainless steel, making it easier to clean and providing better hygiene.
- Tray introduced sideways for easier handling.
- Guides at three heights to offer different working options.
- Guides with "U" shape to prevent the trays from tipping.

- Thermostatic temperature control (125 – 310 °C).
- Heating by means of stainless steel shielded heating elements with selector switch to operate the upper and/or lower zone.
- Oven floor manufactured in 6 mm cast iron, guaranteeing better performance and even heat distribution.
- Fibreglass closing seal to improve the oven's thermal efficiency.
- Dismountable oven door to facilitate repair.

VOLTAGE: 400 V 3+N . Ask for other voltages.



MODEL	CODE	FRY-TOP		OVEN			TOTAL POWER (KW)	DIMENSIONS (mm)	€	
		MEASUREMENTS	COOKING AREAS	POWER (KW)	SIZE	POWER (KW)				
SOLID TOP										
	C-E910	19075495	720x720	4	4x4	-	-	16,00	800x930x290	-
WITH OVEN										
	C-E911	19075498	720x720	4	4x4	GN-2/1	6,00	22,00	800x930x850	-

Induction cookers



General characteristics

- 6 mm thick glass ceramic, hermetically sealed into the 2 mm thick AISI-304 stainless steel surface top.
- Laser-cut joints, automatic welding and polishes. Screws hidden from view.
- Cooking areas demarcated by Ø 280 mm circular screen print, with 5 kW of power in each area, rapidly heated and ideal for à la carte service.
- Perfect control of cooking thanks to the energy regulator with 10 power levels, which allows you to work at low power for delicate recipes or at maximum power for fast service.
- Supplies energy only to the area upon which the container rests, with the rest of the glass ceramic surface remaining cold.
- Only functions when the presence of a cooking container is detected. Heating is interrupted upon removing the container.
- As a result, a great energy saving is obtained (energy consumption is reduced by around 50 % compared to gas burners).
- The working environment and atmosphere is more comfortable, as the energy is concentrated on the base of the container to be heated, irradiation and heat dispersal are reduced and the cooking temperature is reached rapidly.
- Safety against overheating. Diagnosis of errors (flashing lights).
- High temperature enamelled cast iron flue protector.
- Access to the components from the front.
- Machines with IPX5 grade water protection.
- VOLTAGE: 400 V 3ph-

	MODEL	CODE	PLATES		TOTAL POWER (KW)	DIMENSIONS (mm)	€
			5,0 KW	Ø MM			
INDUCTION PANELS							
	C-I925	19075577	2	280	10,00	400x930x290	-
	C-I945	19075578	4	280	20,00	800x930x290	-
WOK							
	W-I905	19075893	1	300	5,00	400x930x290	-

Fry-tops



General characteristics

- Surface tops manufactured in 2 mm thick AISI-304 stainless steel.
- Laser-cut joints, automatic welding and polishes. Screws hidden from view.
- Fry-tops manufactured in 20 mm thick mild steel, high powered and with rapid temperature attainment.
- Versions with 50 micron thick chrome surface for the three types of fry-top.
- Models with smooth, grooved and mixed (2/3 smooth and 1/3 grooved) fry-tops.
- Electrical heated models use stainless steel shielded heating elements; temperature controlled by thermostat, between 100 and 300 °C.
- Gas heated models have burners with two branches (one burner for half module models, two independent burners for models with a whole module).
- Gas models come with the option of thermostatic temperature control (between 100 and 300 °C) or with operation by security valve with thermocouple.
- Gas: Ignition by electronic spark train. Have access tube for manual ignition.
- The whole module fry-tops come with independent heating zones.
- Safety thermostat in models with thermostatic control.
- Rapid reaction and recovery times of the fry-top temperature.
- The fry-tops are integrated into the stamped surface top.
- The stamped housing with rounded edges and corners make them very easy to clean.
- Fry-top tilted towards the front to facilitate fat and liquid collection.
- Fitted with an opening for the collection of cooking fat and storage tray with a capacity of up to 2 litres depending on the model.
- Option of easily dismantlable side and back splash guards.
- High temperature enamelled cast iron flue protector.
- Access to the components from the front.
- Machines with IPX5 grade water protection.

OPTIONAL ACCESSORIES

(see accessories page at end of chapter)

- Scraper (*).
- Splash guard (in three pieces to facilitate cleaning).





















VOLTAGE FOR ELECTRIC MODELS:

- 400 V 3+N - Ask for other voltages.



(*). Models with chrome surface, scraper included

Fry-tops

	MODEL	GAS	CODE	PLATE				TOTAL POWER (KW)	DIMENSIONS (mm)	€
				TYPE (*)	AREAS	(mm)	DM²			
GAS-FRY-TOPS										
MAX-MIN VALVE										
	FT-G905 V L	LPG	19075677	L	1	335x640	21,50	9,25	400x930x290	-
		GN	19075678							
	FT-G905 V R	LPG	19075679	R	1	335x640	21,50	9,25	400x930x290	-
		GN	19075680							
	FT-G910 V L	LPG	19075705	L	2	735x640	47,00	18,50	800x930x290	-
		GN	19075706							
	FT-G910 V R	LPG	19075709	R	2	735x640	47,00	18,50	800x930x290	-
		GN	19075710							
	FT-G910 V LR	LPG	19075707	L+R	2	735x640	47,00	18,50	800x930x290	-
		GN	19075708							
CONTROL BY THERMOSTAT										
	FT-G905 L	LPG	19075669	L	1	335x640	21,50	9,25	400x930x290	-
		GN	19075671							
	FT-G905 R	LPG	19075673	R	1	335x640	21,50	9,25	400x930x290	-
		GN	19075675							
	FT-G910 L	LPG	19075693	L	2	735x640	47,00	18,50	800x930x290	-
		GN	19075695							
	FT-G910 R	LPG	19075701	R	2	735x640	47,00	18,50	800x930x290	-
		GN	19075703							
	FT-G910 LR	LPG	19075697	L+R	2	735x640	47,00	18,50	800x930x290	-
		GN	19075699							
CONTROL BY THERMOSTAT AND CHROMIUM HOT-PLATE										
	FT-G905 C L	LPG	19075661	L / C	1	335x640	21,50	9,25	400x930x290	-
		GN	19075663							
	FT-G905 C R	LPG	19075665	R / C	1	335x640	21,50	9,25	400x930x290	-
		GN	19075667							
	FT-G910 C L	LPG	19075681	L / C	2	735x640	47,00	18,50	800x930x290	-
		GN	19075683							
	FT-G910 C R	LPG	19075689	R / C	2	735x640	47,00	18,50	800x930x290	-
		GN	19075691							
	FT-G910 C LR	LPG	19075685	L+R / C	2	735x640	47,00	18,50	800x930x290	-
		GN	19075687							
ELECTRIC - FRY-TOPS										
CONTROL BY THERMOSTAT										
	FT-E905 L	-	19075639	L	1	335x640	21,50	7,50	400x930x290	-
	FT-E905 R	-	19075642	R	1	335x640	21,50	7,50	400x930x290	-
	FT-E910 L	-	19075654	L	2	735x640	47,00	15,00	800x930x290	-
	FT-E910 R	-	19075660	R	2	735x640	47,00	15,00	800x930x290	-
	FT-E910 LR	-	19075657	L+R	2	735x640	47,00	15,00	800x930x290	-
CONTROL BY THERMOSTAT AND CHROMIUM HOT-PLATE										
	FT-E905 C L	-	19075633	L / C	1	335x640	21,50	7,50	400x930x290	-
	FT-E905 C R	-	19075636	R / C	1	335x640	21,50	7,50	400x930x290	-
	FT-E910 C L	-	19075645	L / C	2	735x640	47,00	15,00	800x930x290	-
	FT-E910 C R	-	19075651	R / C	2	735x640	47,00	15,00	800x930x290	-
	FT-E910 C LR	-	19075648	L+R / C	2	735x640	47,00	15,00	800x930x290	-

(*) TYPE OF PLATE:

L: Smooth hot-plate

R: ribbed hot-plate

L+R: 2/3 smooth and 1/3 ribbed hot-plate

C: chrome surface

Grill



General characteristics

- Surface tops manufactured in 2 mm thick AISI-304 stainless steel.
- Laser-cut joints, automatic welding and polishes. Screws hidden from view.
- Cast iron grills, dismantable without the need for tools, in 170 mm wide sections.
- The iron grills are reversible, with different finishes on each side:
 - Tilted and grooved with ridges for meat.
 - Horizontal and flat for fish and vegetables.
- The grills reach a very high temperature (400 °C), meaning that the surface of the product seals rapidly, keeping the inside of the food much juicier.
- In the models with stainless steel grill, this is manufactured with sheets of AISI-304 in "V" shape to facilitate cleaning.
- Fitted with an opening for the collection of cooking fat and storage tray with a capacity of up to 12 litres (one tray in half module machines, two trays in machines with a whole module).
- The fat collection trays offer the option of putting water in them, and thanks to the heat irradiation of the gas burners or electrical heating elements, low intensity steam is generated, so that the food can be grilled in an atmosphere of steam.
- Grills fitted with 130 mm high dismantable guard to avoid splashing, manufactured in stainless steel.

- High temperature enamelled cast iron flue protector.
- Access to the components from the front.
- Machines with IPX5 grade water protection.

ELECTRIC COUNTERTOP MODELS

- Groups of stainless steel covered elements upon which you can cook food directly (a group of 3 elements for half-sized module models and 2 groups for whole module models).
- Water tray for safety. It also allows an adequate level of humidity to be reached for optimum cooking conditions.

ELECTRIC FLOOR MODELS

- Groups of three stainless steel elements under the roasting rack, with radiant deflector (a group of three elements for half-sized module models, two groups for whole module models).
- Independent control for each group of elements via an energy regulator.

GAS COUNTERTOP MODELS

- Groups of high-efficiency tube burners, (a group of two burners for half-sized module models, two groups for a single module models).
- Independent control for each group of burners via a safety valve with a thermocouple.
- Burners turned on using Piezo electric ignition.

- The burners heat ceramic stones that sit on a supporting rack, so that they can then heat food on the grill.

GAS FLOOR MODELS

- Groups of three high-efficiency tube burners, with a radiant deflector (a group of three burners for half-sized module models, two groups for whole module models).
- Independent control for each group of burners via a safety valve with a thermocouple.
- Burners turned on using electric multi-spark ignition. With an access tube for manual ignition.





Accessories included (See accessories page at the end of the chapter)



Special scraper with two profiles for models with cast iron grill.



Special scraper adapted for models with stainless steel grill.

MODEL	GAS	CODE	GRIDS					TOTAL POWER (kW)	DIMENSIONS (mm)	€
			TYPE	AREAS	QUANTITY	(mm)	(DM ²)			
GAS GRILL										
 Countertop										
B-G905 I	LPG	19078584	Inox	1	1	340x690	24	11	400x930x290	-
	NG	19081684								
B-G905	LPG	19078902	Mild steel	1	2	340x690	24	11	400x930x290	-
	NG	19081682								
B-G910 I	LPG	19078582	Inox	2	2	680x690	48	22	800x930x290	-
	NG	19081686								
B-G910	LPG	19078901	Mild steel	2	4	680x690	48	22	800x930x290	-
	NG	19081685								
B-G915 I	LPG	19081680	Inox	3	3	1020x690	72	33	1200x930x290	-
	NG	19081681								
B-G915	LPG	19079204	Mild steel	3	6	1020x690	72	33	1200x930x290	-
	NG	19081639								
Floor										
B-G9051 I	LPG	19075474	Inox	1	1	340x690	24	11	400x930x850	-
	NG	19075475								
 B-G9051	LPG	19075476	Mild steel	1	2	340x690	24	11	400x930x850	-
	NG	19075478								
B-G9101 I	LPG	19075480	Inox	2	2	680x690	48	22	800x930x850	-
	NG	19075481								
 B-G9101	LPG	19075482	Mild steel	2	4	680x690	48	22	800x930x850	-
	NG	19075484								
ELECTRIC GRILL										
Countertop										
 B-E905	-	19078931	Inox	1	1	255x640	16	5,42	400x930x290	-
B-E910	-	19078922	Inox	2	1	545x640	35	10,84	800x930x290	-
Floor										
B-E9051 I	-	19075417	Inox	1	1	340x690	24	7,5	400x930x850	-
B-E9051	-	19075413	Mild steel	1	2	340x690	24	7,5	400x930x850	-
B-E9101 I	-	19075473	Inox	2	2	680x690	48	15	800x930x850	-
B-E9101	-	19075470	Mild steel	2	4	680x690	48	15	800x930x850	-

Pasta cookers



General characteristics

- Surface tops manufactured in 2 mm thick AISI-304 stainless steel.
- Laser-cut joints, automatic welding and polishes. Screws hidden from view.
- Wells integrated into the surface top, manufactured in 1.5 mm thick AISI-316L stainless steel.
- Wells with 1/1 dimensions, capacity 40 litres. Accommodate different configurations of different sized baskets
- Standard configuration : three 1/3 type baskets per well.
- Optional kit basket type 1/4 and type 1/6.
- Well filling by means of entrance electrovalve with two position switch: medium filling speed and high speed.
- Draining of well by means of high temperature resistant mechanical ball valve with safety overflow.

- Automatic safety system that breaks the circuit if the water runs out.
- Drainer located at the front for the baskets to be rested on.
- Controls with protective base and system against water infiltration. High temperature enamelled cast iron flue protector.
- Access to the components from the front.
- Machines with IPX5 grade water protection.

GAS MODELS

- Gas models with stainless steel burner situated on the outside of the well with combustion chamber that allows the well to be heated from the bottom and sides (up to the minimum filling level).
- Electronic ignition by spark train. Alternative manual ignition tube.
- Heating controlled by safety valve.

ELECTRIC MODELS

- Electric models with AISI-304 stainless steel heating elements situated in the bottom of the well to heat the water directly.
- Heating controls by energy regulator.
- Voltage: 400 V 3+N - Ask for other voltages.

Optional accessories

(see accessories page at end of chapter)

- Kit of 6 baskets 1/6 square.
- Kit of 6 baskets 1/6 round.
- Kit of 2 baskets 1/2.

	MODEL	GAS	CODE	WELL			TOTAL POWER (KW)	DIMENSIONS (mm)	€
				QUANTITY	SIZE	BASKETS (1/3)			
GAS PASTA COOKERS									
	CP-G905	LPG	19075585	1	GN-1/1	3	16,00	400x930x850	-
		NG	19075587						
	CP-G910	LPG	19075589	2	GN-1/1	6	32,00	800x930x850	-
		NG	19075590						
ELECTRIC PASTA COOKERS									
	CP-E905	-	19075581	1	GN-1/1	3	12,00	400x930x850	-
		-	19075584						
	CP-E910	-	19075584	2	GN-1/1	6	24,00	800x930x850	-

Boiling pans



General characteristics

- Surface tops manufactured in 2 mm thick AISI-304 stainless steel.
- Laser-cut joints, automatic welding and polishes. Screws hidden from view.
- Double walled lid balanced by means of a hinge with front handle, with diagonal opening to 75° which allows the lid to be kept open in any position.
- Well stamped into the surface top by robotic welding, manufactured in AISI-304 stainless steel, with the bottom of the well in AISI-316L stainless steel.
- Well filling with hot or cold water by electrovalve, activated with a single switch located on the front panel.
- Well emptying by 2" safety valve with handle in athermic material and safe and effortless handling.
- Robust and reliable filter for draining the well manufactured in AISI-304 stainless steel. Easily extractable.
- Controls with protective base and system against water infiltration.
- High temperature enamelled cast iron flue protector.
- Access to the components from the front.
- Machines with IPX5 grade water protection.

Indirectly heated models – bain marie

- Bain marie chamber around the well, with automatic filling system when the machine is connected.
- Automatic chamber level control with quadruple security: pressure switch to control the pressure in the chamber, overpressure security valve, thermostat to limit overheating in the chamber and pressure gauge incorporated into the surface top.
- Automatic flushing of the chamber.
- Heating at the bottom of the pan acts on the water in the surrounding chamber, meaning that the saturated steam generated at a temperature of 107 °C heats the bottom and sides of the well in a uniform manner. The temperature reached is lower than that obtained with direct heating.
- Stamped pan floor to avoid deformations.
- Indicator light to show when the machine is connected and when it is heating.

GAS MODELS

- Group of optimised combustion stainless steel tubular burners, controlled by energy regulator and by pressure switch.
- Control by energy regulator and by pressure switch, permitting lower water and energy consumption.
- Ignition of group of burners by spark train.

ELECTRIC MODELS

- Heating by heating elements located in the lower part of the bain marie.
- Heating controlled by energy regulator and pressure switch.
- Voltage: 400 V 3+N - Ask for other voltages.

PRESSURE OPERATION

- Folding and compensated lid, with flange closure
- Operation with pressure in the cooking well, 0.3 atmospheres.
- Overpressure safety valve on the lid.

	MODEL	HZ.	CODE		TANK		TOTAL POWER (KW)	DIMENSIONS (mm)	€	
			LPG	NG	Ø X H (mm)	VOLUME (L)				
GAS BOILING PANS										
Direct fire										
		M-G910	50	19075824	19075826	600x400	100	20,00	800x930x850	-
			60	19075825	19075827					
		M-G915	50	19075832	19075834	600x550	150	24,00	800x930x850	-
			60	19075833	19075835					
	M-G920	50	19075836	19075838	600x650	200	24,00	800x930x850	-	
		60	19075837	19075839						
Indirect flame										
	M-G910 BM	50	19075819	19075822	600x400	100	20,00	800x930x850	-	
		60	19075820	19075823						
	M-G915 BM	50	19075828	19075830	600x550	150	24,00	800x930x850	-	
		60	19075829	19075831						
Pressure										
	MP-G910	50	19075840	19075842	600x400	100	20,00	800x930x850	-	
		60	19075841	19075843						
	MP-G915	50	19075845	19075846	600x550	150	24,00	800x930x850	-	
		60	19075844	19075847						
	MP-G920	50	19075848	19075850	600x650	200	24,00	800x930x850	-	
		60	19075849	19075851						
ELECTRIC BOILING PANS										
Indirect flame										
		M-E910 BM	-	19075814	600x400	100	22,00	800x930x850	-	
		M-E915 BM	-	19075817	600x550	150	22,00	800x930x850	-	

Fryers



General characteristics

- Surface tops manufactured in 2 mm thick AISI-304 stainless steel.
- Laser-cut joints, automatic welding and polishes. Screws hidden from view.
- Wells stamped into the surface top.
- Cold zone in the lower part of the well, which helps to maintain the quality and characteristics of the oil in use for longer.
- Thermostatic temperature control between 60 and 200 °C.
- Gas models with three longitudinal heating tubes integrated into the well.
- High efficiency gas burners.
- Electric models with AISI-304 stainless steel heating elements located inside the well, which can be swivelled by more than 90° for perfect cleaning.
- High-power machines which heat up very fast and with a high power:litre ratio (up to 1.00 kW/litre in gas models).
- Ignition by spark train for the gas models.
- Safety thermostat in all models.

- Unloading of oil from the well by means of a robust and reliable ball valve, resistant to high temperatures.
- With individual lids for each well.
- High temperature enamelled cast iron flue protector.
- Access to the components from the front.
- Machines with IPX5 grade water protection.

MODEL WITH DIGITAL CONTROL:

- High-precision electronic oil temperature control between 60-200°C, +/- 1°C.

- Setpoint temperature display with an indicator to show when temperature has been reached.
- Time control card per basket with audible alarm.
- "Melting" programme.

SUPPLIED BASKETS

- 21-litre fryers: 2 small baskets per well (130 x 330 x 130 mm).
- 15-litre fryers: 1 small basket per well (250 x 280 x 100 mm).

Optional accessories

(see accessories page at the end of the chapter)

- 21-litre fryers: large basket (260 x 330 x 130 mm).
- 15-litre fryers: small basket (125 x 280 x 100 mm).

	MODEL	HZ.	CODE		QUANTITY	TANKS		TOTAL POWER (KW)	DIMENSIONS (mm)	€	
			LPG	GN		VOLUME (L)	BASKETS				
GAS FRYERS											
	F-G9115	50	19078845	19081732	1	1x15	1 large	15,00	400x930x850	-	New
		60	19081730	19081733							
	F-G9215	50	19081735	19081738	2	2x15	2 large	30,00	800x930x850	-	New
		60	19081736	19081739							
	F-G9121	50	19075613	19075616	1	1x21	2 small	21,00	400x930x850	-	
		60	19075615	19075618							
	F-G9221	50	19075625	19075628	2	2x21	4 small	42,00	800x930x850	-	
		60	19075627	19075630							
ELECTRIC FRYERS											
	F-E9115	19075597	19078867		1	1x15	1 large	12,00	400x930x850	-	New
	F-E9215	19081692	19081692		2	2x15	2 large	24,00	800x930x850	-	New
	F-E9121	19075600	19075600		1	1x21	2 small	18,00	400x930x850	-	
	F-E9121 D	19075900	19075900		1	1x21	2 small	21,00	400x930x850	-	
	F-E9221	19075606	19075606		2	2x21	4 small	36,00	800x930x850	-	

D: Digital control.

Chips scuttle



General characteristics

- Half module electrical heating machine, heated by infrared light.
- Surface tops manufactured in 2 mm thick AISI-304 stainless steel.
- Laser-cut joints, automatic welding and polishes. Screws hidden from view.
- Pan stamped into surface top, with capacity for 150 mm high Gastronorm GN-1/1 container.
- Perforated double bottom manufactured in stainless steel, tilted to remove excess frying oil and collect it in the container.
- Heat maintained by infrared lamp located at the back of the machine, operated by ON/OFF switch.
- Control with system against water infiltration.
- High temperature enamelled cast iron flue protector.
- Access to the components from the front.
- Machines with IPX5 grade water protection.

	MODEL	CODE	WELLS	POWER (KW)	DIMENSIONS (mm)	€
	MF-E905	19075818	GN-1/1	1,00	400x930x290	-

Tilting bratt pans



General characteristics

- Laser-cut joints, automatic welding and polishes. Screws hidden from view.
- Motorised or crank operated elevation systems which are able to raise the pan until it is vertical, to empty it completely.
- Versions with cast iron and stainless steel pans.
- Pan design with a rounded corners and no edges, and with a wide opening for unloading, making all cooking and cleaning operations easier.
- Flange around the perimeter to stop any condensed water from spilling over.
- The bottom of the wells is very thick (8 mm for iron pans and 10 mm for stainless steel pans), guaranteeing even heat distribution.
- Pans filled with water by means of electric valve operated with switch on the front of the machine. The filling pipe is located at the back of the machine.

- Double walled lid with drainer at the back to redirect water of condensation back into the well.
- Lid balance system by springs. Compensation system to avoid heavy falls. Can be regulated, with the same system for all modules.
- Micro breaking switch halts heating when the pan is raised.
- High temperature enamelled cast iron flue protector.
- Access to the components from the front.

- Machines with IPX5 grade water protection.
- Front access lid handle.
- Electrically heated models use shielded stainless steel heating elements located under the bottom of the pan.
- Gas heated models use steel burners with six branches (eight in the pan with one and a half modules), operated and controlled by safety valve with thermocouple.
- Temperature of the bottom of the pan controlled by thermostat, between 50 and 310 °C.

- The heating by branched burners or electrical heating elements located in the base of the pan itself, together with the high thickness of the bottom of the pan, ensure maximum uniformity of temperature distribution in all cases, guaranteeing even cooking.

VOLTAGE FOR ELECTRIC MODELS:

- 400 V 3+N - Ask for other voltages.

MODEL	HZ.	CODE		RAISING SYSTEM	TANK TYPE (*)	CAPACITY (L)	SURFACE		TOTAL POWER (KW)	DIMENSIONS (mm)	€
		LPG	GN				(mm)	(DM ²)			
GAS TILTING BRATT PANS											
SB-G910 I	50	19075867	19075876	Manual	Stainless steel	90	730x616	45	18,00	800x930x850	-
	60	19075869	19075878								
SB-G910	50	19075879	19075885	Manual	Cast Iron	90	730x616	45	18,00	800x930x850	-
	60	19075880	19075886								
SB-G910 IM	50	19075870	19075873	Motorized	Stainless steel	90	730x616	45	18,00	800x930x850	-
	60	19075872	19075875								
SB-G910 M	50	19075881	19075883	Motorized	Cast Iron	90	730x616	45	18,00	800x930x850	-
	60	19075882	19075884								
SB-G915 IM	50	19075887	19075890	Motorized	Stainless steel	120	1.130x616	70	25,00	1.200x930x850	-
	60	19075889	19075892								
ELECTRIC TILTING BRATT PANS											
SB-E910 I		19075857		Manual	Stainless steel	90	730x616	45	15,00	800x930x850	-
SB-E910		19075854		Manual	Cast Iron	90	730x616	45	15,00	800x930x850	-
SB-E910 IM		19075860		Motorized	Stainless steel	90	730x616	45	15,00	800x930x850	-
SB-E910 M		19075863		Motorized	Cast Iron	90	730x616	45	15,00	800x930x850	-
SB-E915 IM		19075866		Motorized	Stainless steel	120	1.130x616	70	22,50	1.200x930x850	-

Bain maries



General characteristics

- Surface tops manufactured in 2 mm thick AISI-304 stainless steel.
- Laser-cut joints, automatic welding and polishes. Screws hidden from view.
- Wells accommodating different configurations of Gastronorm containers of different sizes, 150 mm high and with dimensions:
- Half module: GN-1/1+1/3, with 22 litres capacity.
- One module: GN-2/1+(2x1/3), with 44 litres capacity.
- Wells stamped into the surface top, manufactured with AISI-304 stainless steel.
- Standard format: 3 crosspieces to support Gastronorm containers.

- Simple draining of the well by removing the overflow tube.
- The filling tap is sold as an optional accessory.
- Regulation of water temperature by thermostat, between 30 and 90 °C.
- Controls with protective base and system against water infiltration (IPX5 grade protection).
- High temperature enamelled cast iron flue protector.
- Access to the components from the front.
- Machines with IPX5 grade water protection.

GAS MODELS

- Insulated combustion chamber, reducing heating of components.
- High efficiency stainless steel burner, located on the outside of the well.

- Electronic ignition by spark train.
- Tube for alternative manual ignition.

ELECTRIC MODELS

- AISI-304 stainless steel heating elements located on the outside of the well.
- Safety thermostat in the electric models
- Voltage: 400 V 3+N. It can be transformed to other voltages..

OPTIONAL ACCESSORIES



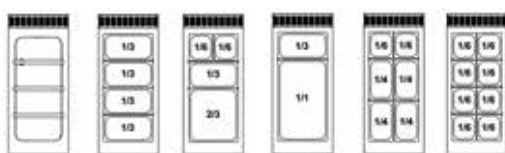

- (see accessories page at end of chapter)
- Simple tap to install at the back of the bain marie.

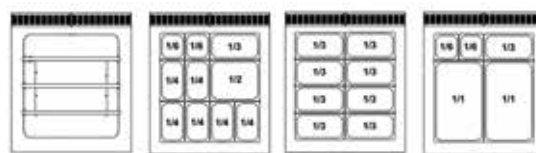

BM 905 Wells



BM 910 Wells





	MODEL	GAS	CODE	TANK SIZE	VOLUME (L)	TOTAL POWER (KW)	DIMENSIONS (mm)	€
GAS BAIN MARIE								
	BM-G905	LPG	19075491	GN-4/3	22	3,25	400x930x290	-
		NG	19075492					
	BM-G910	LPG	19075493	GN-8/3	44	6,50	800x930x290	-
		NG	19075494					
ELECTRIC BAIN MARIE								
	BM-E905	-	19075487	GN-4/3	22	3,00	400x930x290	-
	BM-E910	-	19075490	GN-8/3	44	6,00	800x930x290	-

Neutral elements



General characteristics

- Half module and one module appliances.
- Surface tops manufactured in 2 mm thick AISI-304 stainless steel.
- Laser-cut joints, automatic welding and polishes. Screws hidden from view.
- Machines adapted for the connection of a filling tap or water column at the back.
- High temperature enamelled cast iron back flue trim.

	MODEL	CODE	DRAWERS		DIMENSIONS (mm)	€
			QUANTITY	(mm)		
	EN-9025	19048351	-	-	200x930x290	-
	EN-905	19075591	-	-	400x930x290	-
	EN-910	19075593	-	-	800x930x290	-
	EN-905 C	19075592	1	300x590x105 (valid GN-1/1)	400x930x290	-
	EN-910 C	19075594	1	700x590x105	800x930x290	-





(*) It can only be in central blocks or murals without verticality.

Stands



General characteristics

- Manufactured with a solid structure in AISI-304 stainless steel.
- Screws hidden from view.
- Rapidly connected to serve as supports for surface top type elements from the 900 KORE range.
- Can be used as open storage elements.
- Designed for the attachment of doors to turn them into closed cupboards.

	MODEL	CODE	DOORS IN OPTION (NOT INCLUDED)	DIMENSIONS (mm)	€
	MB-9025	19048470	-	200x860x560	-
	MB-905	19018700	1	400x860x560	-
	MB-910	19022189	2	800x860x560	-
	MB-915	19020374	3	1.200x860x560	-

Doors for stands

The kit allows the door to be reversible, so that it can be assembled opening to the left or to the right. The number of doors depends on the stand to which they are to be mounted:





CODE	DESCRIPTION	€
 19040900	DOOR KIT KORE	-

Refrigerated stands



General characteristics

- Sealed compressor with ventilated condenser.
 - Copper pipe evaporator with aluminum wings.
 - 50 mm injected polyurethane insulation with a density of 40kg/m³.
 - BP models with panoramic door opening and automatic closing device with stay open feature above 90°.
 - Height adjustable stainless-steel legs (from 130mm to 190mm) allows adjusting the overall height of the counter from 580 to 640mm.
 - Forced air refrigeration system
 - Working temperature: -2 °C, +8 °C, at room temperature of 38 °C.
 - Climate Class 4
 - Electronic temperature and defrosting control and display.
 - BP model with doors and B model with GN 1/1 holding capacity drawers.
 - BH model with a full-length flat drawer with GN2/1 holding capacity and equipped with 5 crosspieces to support different combinations of GN containers.
- Options:
- Kit of 6 castors (2 with brakes). Factory fitted.
 - 60Hz

MODEL	COOLANT	HZ.	CODE	N. DOORS AND DRAWERS	ENERGY EFFICIENCY CLASS	GROSS CAPACITY (L)	ANNUAL ENERGY CONSUMPTION (KW-H)	ELECTRIC POWER(W)	DIMENSIONS (mm)	€
MODELS WITH DOORS										
 EMFP9-120 BP	R-290	50	19048089	2	C	169	714	250	1.200x900x590	-
 EMFP9-160 BP	R-290	50	19068878	3	C	240	1113	250	1.600x900x590	-
MODELS WITH 2/3 DRAWERS										
 EMFP9-120 B	R-290	50	19048090	2 x 2/3	C	169	714	250	1.200x900x590	-
 EMFP9-160 B	R-290	50	19068870	3 x GN 1/1	C	240	1113	250	1.600x900x590	-
MODELS WITH FULL LENGTH FLAT DRAWERS										
 EMFP9-120 BH	R-290	50	19047995	2 x GN 2/1	C	169	777	250	1.200x900x590	-

Kore 900 cantilever system





Central or wall blocks

Non-vertical blocks







Supports

TYPE	BLOCK TYPE	DESCRIPTION	CODE	€
SINGLE SMOOTH PANEL FOR MACHINERY				
	CENTRAL OR WALL BLOCK	Left smooth panel	19081817	-
		Right smooth panel	19081818	-
		Left smooth panel for block with a tilting bratt pan on the end.	19081819	-
		Right smooth panel for block with a tilting bratt pan on the end.	19081820	-
DOUBLE WALL TRIMMING FOR EACH SIDE BLOCK*				
	CENTRAL BLOCK	Side trim for Kore 900 block	19081826	-
		Side trim for mixed Kore 900 + Kore 700 block Left Kore 700 and Right Kore 900.	19081827	-
		Side trim for mixed Kore 900 + Kore 700 block Left Kore 700 and Left Kore 900.	19081828	-
	WALL BLOCK	Left side trim	19081824	-
		Right side trim	19081825	-

Racks and shelves

TYPE	DESCRIPTION	CODE	€
GAS*			
	Gas burner base 1 M	19081800	-
	Gas burner base 1,5 M	19081789	-
	Gas burner base 2 M	19081788	-
	Gas burner base 2,5 M	19081787	-
	Gas burner base 3 M	19081786	-
	Gas burner base 3,5 M	19081785	-
	Gas burner base 4 M	19081784	-
	Gas burner base 4,5 M	19081783	-
	Gas burner base 5 M	19081782	-
ELECTRIC			
	Electric burner base 1 M	19081809	-
	Electric burner base 1,5 M	19081808	-
	Electric burner base 2 M	19081807	-
	Electric burner base 2,5 M	19081806	-
	Electric burner base 3 M	19081805	-
	Electric burner base 3,5 M	19081804	-
	Electric burner base 4 M	19081803	-
	Electric burner base 4,5 M	19081802	-
	Electric burner base 5 M	19081801	-

*If one appliance on the block uses gas, select gas burners bases.





Central or wall block
Vertical blocks





Supports

TYPE	DESCRIPTION	CODE	€
NEUTRAL ELEMENTS			
	Standard	19075224	-
	Standard with plug	19075225	-
	Standard with tap	19075226	-
FOR MACHINERY*			
	For optima oven	19075227	-
	For salamander	19075228	-





*You cannot put trimming on if a tilting bratt pan is attached to the end.

Racks and shelves

TYPE	SUPPORT TYPE	BLOCK LENGTH					
		2M	2 1/2M	3M	3 1/2M	4M	4 1/2M
CENTRAL BLOCK							
	Rack						
	For two standard elements	19075320	19075321	19075322	19075323	19075324	19075325
		-	-	-	-	-	-
	For 1 standard support + 1 machine support	19075327	19075328	19075329	19075330	19075331	19075332
		-	-	-	-	-	-
	For 2 machinery supports	-	19075335	19075336	19075337	19075338	19075339
		-	-	-	-	-	-
	Shelf						
	For two standard elements	19075344	19075345	19075347	19075348	19075349	19075370
		-	-	-	-	-	-
	For 1 standard support + 1 machinery support	19075372	19075373	19075374	19075375	19075376	19075377
		-	-	-	-	-	-
	For 2 machinery supports	-	19075380	19075381	19075382	19075383	19075384
		-	-	-	-	-	-
WALL BLOCK							
	Rack						
	For two standard elements	19075316	19075317	19075318	19075319	19075340	19075341
		-	-	-	-	-	-
	Shelf						
	For two standard elements	19075386	19075387	19075388	19075389	19075390	19075391
		-	-	-	-	-	-





Finishings

TIPO	DESCRIPCIÓN	CÓDIGO	€
CENTRAL BLOCK			
Single smooth panel for machinery 	Left smooth panel	19081769	-
	Right smooth panel	19081770	-
	Left smooth panel for block with a tilting bratt pan on the end	19081771	-
	Right smooth panel for block with a tilting bratt pan on the end	19081772	-
Double trim for each side block* 	Side trim for Kore 900 central block	19081778	-
	Side trim for mixed Kore 900 + Kore 700 central block: Left Kore 700 right Kore 900	19081779	-
	Side trim for mixed Kore 900 + Kore 700 central block: Right Kore 700 left Kore 900	19081780	-
WALL BLOCK			
Single smooth panel for machinery 	Left smooth panel	19081765	-
	Right smooth panel	19081766	-
	Left smooth panel for block with a tilting bratt pan on the end.	19075227	-
	Right smooth panel for block with a tilting bratt pan on the end.	19075228	-
Double trim for each side block* 	Left side trim	19081776	-
	Right side trim	19081777	-

*You cannot put trimming on if a tilting bratt pan is attached to the end.

Burner base

TIPO	DESCRIPTION	CODE	€
GAS* 	Gas burner base 1 M	19081800	-
	Gas burner base 1,5 M	19081789	-
	Gas burner base 2 M	19081788	-
	Gas burner base 2,5 M	19081787	-
	Gas burner base 3 M	19081786	-
	Gas burner base 3,5 M	19081785	-
	Gas burner base 4 M	19081784	-
	Gas burner base 4,5 M	19081783	-
	Gas burner base 5 M	19081782	-
ELECTRIC 	Electric burner base 1 M	19081809	-
	Electric burner base 1,5 M	19081808	-
	Electric burner base 2 M	19081807	-
	Electric burner base 2,5 M	19081806	-
	Electric burner base 3 M	19081805	-
	Electric burner base 3,5 M	19081804	-
	Electric burner base 4 M	19081803	-
	Electric burner base 4,5 M	19081802	-
Electric burner base 5 M	19081801	-	

*If one appliance on the block uses gas, select gas burners bases.



Suspended blocks: Central or wall

Non-vertical blocks



Finishings

Each kit below contains:

- Support modules built with 4 mm AISI-304 stainless steel frames.
- Support arms to hold the machines in place, made from AISI-304 stainless steel.
- Rear supports also made from AISI-304.
- Smooth closure panels at the side as well as the front (if you want a finish with side trim instead of a flat panel, request the kit and check).
- Supporting feet.

*All these parts will be provided after receiving the machinery plan.

TYPE	DESCRIPTION	CODE	€
ASSEMBLY KITS WITH SMOOTH PANEL FINISH.			
Suspended central block	Kore central suspended kit 1,5 M	19044944	-
	Kore central suspended kit 2 M	19044945	-
	Kore central suspended kit 2,5 M	19044946	-
	Kore central suspended kit 3 M	19044947	-
	Kore central suspended kit 3,5 M	19044948	-
	Kore central suspended kit 4 M	19044949	-
	Kore central suspended kit 4,5 M	19044950	-
	Kore central suspended kit 5 M	19044951	-
	Kore central suspended kit 5,5 M	19044952	-
	Kore central suspended kit 6 M	19044953	-
Suspended wall block	Suspended wall block 1,5 M	19044933	-
	Suspended wall block 2 M	19044934	-
	Suspended wall block 2,5 M	19044935	-
	Suspended wall block 3 M	19044936	-
	Suspended wall block 3,5 M	19044937	-
	Suspended wall block 4 M	19044938	-
	Suspended wall block 4,5 M	19044939	-
	Suspended wall block 5 M	19044940	-
	Suspended wall block 5,5 M	19044941	-
	Suspended wall block 6 M	19044942	-
SIDE TRIM FINISHING			
Suspended central or wall block	Kit to provide a suspended block with lateral supports and side trim*	Consultar	

* Add to the kit order.

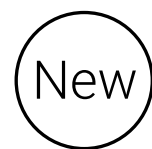



Vertical blocks

Supports

TYPE	DESCRIPTION	CODE	€
Neutral elements 	Standard	19075392	-
	Standard with plug	19075393	-
	Standard with tap	19075394	-
For machinery* 	For optima oven	19075395	-
	For salamander	19075396	-

* Not suitable for suspended wall blocks. Must be placed on neutral parts measuring 1 M on both sides.

Racks and shelves

TYPE	SUPPORT TYPE	BLOCK LENGTH					
		2M	2 1/2M	3M	3 1/2M	4M	4 1/2M
SUSPENDEd CENTRAL BLOCK							
Rack 	For two standard elements	19075398 -	19075399 -	19075400 -	19075401 -	19075402 -	19075403 -
	For 1 standard support + 1 machine support	19075405 -	19075406 -	19075407 -	19075408 -	19075409 -	19075420 -
	For 2 machinery supports	- -	19075423 -	19075424 -	19075425 -	19075426 -	19075427 -
Shelf 	For two standard elements	19075436 -	19075437 -	19075438 -	19075439 -	19075440 -	19075441 -
	For 1 standard support + 1 machine support	19075443 -	19075444 -	19075445 -	19075446 -	19075447 -	19075448 -
	For 2 machinery supports	- -	19075453 -	19075454 -	19075455 -	19075456 -	19075457 -
SUSPENDEd WALL BLOCK							
Rack 	For two standard elements	19075429 -	19075430 -	19075431 -	19075432 -	19075433 -	19075434 -
	Shelf 	19075459 -	19075460 -	19075461 -	19075462 -	19075463 -	19075464 -



Finishings

Each kit below contains:

- Support modules built with 4 mm AISI-304 stainless steel frames.
- Support arms to hold the machines in place, made from AISI-304 stainless steel.
- Rear supports also made from AISI-304.

- Smooth closure panels at the side as well as the front (if you want a finish with side trim instead of a flat panel, request the kit and check).
- Supporting feet.

*All these parts will be provided after receiving the machinery plan.

TYPE	DESCRIPTION	CODE	€
ASSEMBLY KITS WITH SMOOTH PANEL FINISH.			
Suspended central block	Kore central suspended kit 1,5 M	19044944	-
	Kore central suspended kit 2 M	19044945	-
	Kore central suspended kit 2,5 M	19044946	-
	Kore central suspended kit 3 M	19044947	-
	Kore central suspended kit 3,5 M	19044948	-
	Kore central suspended kit 4 M	19044949	-
	Kore central suspended kit 4,5 M	19044950	-
	Kore central suspended kit 5 M	19044951	-
	Kore central suspended kit 5,5 M	19044952	-
	Kore central suspended kit 6 M	19044953	-
Suspended wall block	Kore central suspended kit 1,5 M	19044933	-
	Kore central suspended kit 2 M	19044934	-
	Kore central suspended kit 2,5 M	19044935	-
	Kore central suspended kit 3 M	19044936	-
	Kore central suspended kit 3,5 M	19044937	-
	Kore central suspended kit 4 M	19044938	-
	Kore central suspended kit 4,5 M	19044939	-
	Kore central suspended kit 5 M	19044940	-
	Kore central suspended kit 5,5 M	19044941	-
Kore central suspended kit 6 M	19044942	-	
SIDE TRIM FINISHING			
Suspended central or wall block	Kit to provide a suspended block with lateral supports and side trim*	Consultar	-

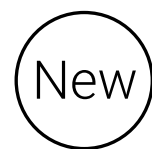

* Add to the kit order.

Bridge block





Each kit below contains:

- Support modules built with 4 mm AISI-304 stainless steel frames.
 - Support arms to hold the machines in place, made from AISI-304 stainless steel.
 - Rear supports also made from AISI-304.
 - Smooth closure panels at the side as well as the front (if you want a finish with side trim instead of a flat panel, request the kit and check).
 - Supporting feet.
- * All these parts will be provided after receiving the machinery plan.

TYPE	DESCRIPTION	CODE	€
ASSEMBLY KITS			
	Bridge kit for Kore block 1 M	19044954	-
	Bridge kit for Kore block 1,5 M	19044955	-
	Bridge kit for Kore block 2 M	19044956	-
	Bridge kit for Kore block 2,5 M	19044957	-
	Bridge kit for Kore block 3 M	19044958	-
	Bridge kit for Kore block 3,5 M	19044959	-
	Bridge kit for Kore block 4 M	19044960	-
EXTERIOR TERMINATION			
Single smooth panel for machinery 	Left smooth panel	19081817	-
	Right smooth panel	19081818	-
	Left smooth panel for block with a tilting bratt pan on the end	19081819	-
	Right smooth panel for block with a tilting bratt pan on the end	19081820	-
Double trim for each side block * 	Left side trim	19081824	-
	Right side trim	19081825	-
INTERIOR TERMINATION			
	Interior individual panel for bridge block	19081993	-





Burner base

TYPE	DESCRIPTION	CODE	€	
GAS* 	Gas burner base 0,5 M	19081990	-	
	Gas burner base 1 M	19081800	-	
	Gas burner base 1,5 M	19081789	-	
	Gas burner base 2 M	19081788	-	
	Gas burner base 2,5 M	19081787	-	
	Gas burner base de 3 M	19081786	-	
	Gas burner base 3,5 M	19081785	-	
	Gas burner base 4 M	19081784	-	
	Gas burner base 4,5 M	19081783	-	
	Gas burner base 5 M	19081782	-	
	ELECTRIC 	Electric burner base 0,5 M	19081991	-
		Electric burner base 1 M	19081809	-
Electric burner base 1,5 M		19081808	-	
Electric burner base 2 M		19081807	-	
Electric burner base 2,5 M		19081806	-	
Electric burner base 3 M		19081805	-	
Electric burner base 3,5 M		19081804	-	
Electric burner base 4 M		19081803	-	
Electric burner base 4,5 M		19081802	-	
Electric burner base 5 M		19081801	-	



*If one appliance on the block uses gas, select gas burners bases.

Accessories



Cooker accessories

	DESCRIPTION	FOR MODELS	CODE	€
	KORE water column kit left		19044979	-
	KORE water column kit right		19044980	-
	KORE SMOOTH FRY-TOP (350 x 300 mm)		19045076	-
	Wok pan adaptor		19045085	-
	Kit 2 brass transmitters (1 x 5.25 kW + 1 x 8 Kw)	C-G920	19084551	-
	Kit 2 high power brass transmitters (1 x 8 kW + 1 x 10.2 Kw)	C-G920 H	19084552	-
	Kit 4 brass transmitters (2 x 5.25 kW + 1 x 8 kW + 1 x 10.2 kW)	C-G940, C-G941, C-GE941	19084553	-
	Kit 4 high power brass transmitters (3 x 8 kW + 1 x 10.2 kW)	C-G940 H, C-G941 H	19084554	-
	Kit 6 brass transmitters (3 x 5.25 kW + 2 x 8 kW + 1 x 10.2 kW)	C-G960, C-G961, C-G961 OP	19084555	-
	Kit 6 high power brass transmitters (5 x 8 kW + 1 x 10.2 kW)	C-G960 H, C-G961 H, C-G961 OP H	19084556	-



Fryer accessories

	DESCRIPTION	CODE	€
	21L large fryer basket	19045077	-
	15L small fryer basket	19045079	-



Fry-top accessories

	DESCRIPTION	CODE	€
	KORE 0.5M fry-top guard	19045081	-
	KORE 1M fry-top guard	19045082	-
	Fry-top scraper	19045083	-



Accessories for charcoals

	DESCRIPTION	CODE	€
	KORE charcoal scraper - FE Grill	19045084	-
	KORE charcoal scraper - Stainless steel Grill	19058313	-

Accessories for boiling pans

	DESCRIPTION	CODE	€
	Kit two perforated baskets for 100 litres boiling pans	19060752	-
	Kit two perforated baskets for 150 litres boiling pans	19061190	-
	Couscoussier kit for pans	19052940	-

Pasta cooker accessories

DESCRIPTION	CODE	€
 Pasta cooker baskets kit – 6x1/6 square	19036341	-
 Pasta cooker baskets kit – 6x1/6 round	19036342	-
 Pasta cooker baskets kit – 2x1/2	19036340	-

Tall chimney kit

DESCRIPTION	CODE	€
Tall chimney kit	19081001	-
 Tall chimney kit 1/4 M Kore 900 appliances	19080999	-
Tall chimney kit 1/2 M Kore 900 appliances	19080990	-
Tall chimney kit 1 M Kore 900 appliances	19081000	-

* Can be installed in all appliances except electric fryers.

Bain marie accessories

DESCRIPTION	CODE	€
 KORE filling tap kit left	19044981	-
KORE filling tap kit right	19044982	-

Machines with wheels

DESCRIPTION	CODE	€
 KORE kit of 4 wheels	19044983	-
KORE kit of 2 fixed wheels	19044985	-

Transformations to other voltages - "marine" version (*)

Machines destined for ships, 440 V - 3 Phase, should be requested in the order indicating these data:

- Code for the standard appliance 400 V 3+N.

- Note for assembly 440 V - 3 phases without neutral.

DESCRIPTION	CODE	€
MARINE - Tilting bratt pans and boiling pans - Transformation for ship - 440 III	19057294	-
MARINE - Other appliances - Transformation for ship - 440 III	(*)	-
230 III - Transformation to 230 V three-phase without neutral	(*)	-
230 1N - Transformation to 230 V single-phase	(*)	-

(*): Consult the existence of a version for this voltage



Maximum performance in reduced spaces.



Find out more!



Access the website



Comercial video



Sales brochure

700 Series

Gas cookers.....	047
Gas solid tops with open burners.....	049
Gas solid tops.....	050
Paella cookers.....	051
Electric cookers.....	052
Electric solid tops.....	053
Induction cookers.....	054
Fry-tops.....	055
Grills.....	057
Pasta cookers.....	059
Boiling pans.....	060
Fryers.....	061
Chips scuttle.....	062
Tiling bratt pans.....	063
Bain marie.....	064
Neutral elements.....	065
Stands.....	066
Refrigerated stands.....	067
Kore 700 blocks and verticality.....	068
Accessories.....	077

All gas cooking equipment
 should be fitted with gas governors:
 LPG: 37 g/cm²
 Natural Gas: 20 g/cm²

Gas cookers



General characteristics

- Stamped surface tops manufactured in 1.5 mm thick AISI-304 stainless steel
- Laser-cut joints and automatic welding. Hidden screws
- 397 x 580 mm double grates (397 x 290 mm for each burner) enabling the use of large pots and pans. The reduced distance of 75 mm between the central bars makes it possible to use pots with a very small diameter (8 cm), avoiding the risk of smaller pans tipping over.
- The grates are made of RAAF enamelled cast iron (resistant to alkaline and acid products, fire and high temperatures).
- Double-crown burners and diffusers made of nickel-plated cast iron which guarantee an even distribution of heat from the flame to the base of the pans, even for large pans. This therefore prevents heat from building up in a specific point and optimises energy transfer to the product.
- Burners of different strengths to adapt to containers and for use with different foods:
 - 5.25 kW (Ø 100 mm),
 - 8.0 kW (Ø 120 mm),
- Burners are easy to position
- Low-consumption pilot light and thermocouple located within the body of the burner for greater protection.
- Flexible stainless-steel gas pipes, facilitating internal manipulations in order to make repairs easier.

- Controls with a protective support base and system to prevent water infiltration.
- High-temperature enamelled cast iron flue protector which is flush with the grates therefore improving manoeuvrability, supporting larger containers and increasing the usable surface area.
- Access to components from the front.

OVEN

- Possibility of choosing between a static gas oven with dimensions NG 2/1 or a side-opening English-style oven with dimensions 860 x 570 x 410 mm with a side-opening double door; or an electric oven with dimensions NG 2/1.
- Cooking chamber made entirely of stainless steel which makes cleaning easier and ensures greater hygiene.
- Trays are inserted sideways which improves manoeuvrability.
- Heating:
 - Gas: Tubular stainless-steel burner with pilot light and thermocouple and piezoelectric ignition.
 - Electric: Heating through stainless steel heating elements with selector switch for operation of the upper and/or inner part.
- Thermostatic valve for temperature control (125 - 310 °C).

- Rails on three height levels to offer different cooking options.
- Rails with anti-tipping system to prevent trays from overturning.
- Cast iron oven floor which guarantees better performance and uniform heat distribution.
- Fibreglass closing seal to improve the thermal efficiency of the oven and ensure its durability.
- Stamped oven frame and inner door, ensuring a better oven closure.
- Detachable oven door to facilitate repairs.

Optional accessories (See accessories page at the end of the chapter)

- Frying plate to place on 5.25 kW burners.
- Water column.

MODEL	GAS	CODE	GRILLS (mm)	BURNERS		OVEN		TOTAL POWER(KW)	DIMENSIONS	€
				5,25 KW	8 KW	SIZE	POWER (KW)			
TOP										
 C-G720	LPG	19068008	397x290	2	-	-	-	10,50	400x730x290	-
	NG	19074175								
 C-G720 H	LPG	19068057	397x290	-	2	-	-	16,00	400x730x290	-
	NG	19074760								
 C-G740	LPG	19060614	397x290	3	1	-	-	23,75	800x730x290	-
	NG	19073557								
 C-G740 H	LPG	19068058	397x290	-	4	-	-	32,00	800x730x290	-
	NG	19074761								
 C-G760	LPG	19068059	397x290	4	2	-	-	37,00	1200x730x290	-
	NG	19074762								
 C-G760 H	LPG	19068110	397x290	-	6	-	-	48,00	1200x730x290	-
	NG	19074763								
GAS STATIC OVEN NG 2/1										
 C-G741	LPG	19058530	397x290	3	1	NG-2/1	8,60	32,35	800x730x850	-
	NG	19073558								
 C-G741 H	LPG	19068112	397x290	-	4	NG-2/1	8,60	40,60	800x730x850	-
	NG	19074765								
 C-G761	LPG	19071404	397x290	4	2	NG-2/1	8,60	45,60	1200x730x850	-
	NG	19073560								
 C-G761 H	LPG	19071463	397x290	-	6	NG-2/1	8,60	56,60	1200x730x850	-
	NG	19074766								
BRITISH STYLE GAS OVEN										
 C-GB761	LPG	19074812	397x290	4	2	860X570X410	8,60	45,60	1200x730x850	-
	NG	19074813								
 C-GB761 R	LPG	19074814	397x290	4	2	860X570X410	8,60	45,60	1200x730x850	-
	NG	19074815								
 C-GB761 H	LPG	19074816	397x290	-	6	860X570X410	8,60	56,60	1200x730x850	-
	NG	19074817								
 C-GB761 RH	LPG	19074819	397x290	-	6	860X570X410	8,60	56,60	1200x730x850	-
	NG	19074820								
ELECTRIC STATIC OVEN NG 2/1										
 C-GE741	LPG	19074821	397x290	3	1	NG-2/1	6,00	29,75	800x730x850	-
	NG	19074822								
 C-GE741 H	LPG	19074823	397x290	-	4	NG-2/1	6,00	38,00	800x730x850	-
	NG	19074824								

H MODELS: With high-power burners
R MODELS: With wheels

Gas solid tops with open burners



General characteristics

- Stamped surface tops manufactured in 1.5 mm thick AISI-304 stainless steel.
- Laser-cut joints and automatic welding. Hidden screws.
- 397 x 580 mm double grates (397 x 290 mm for each burner) enabling the use of large pots and pans. The reduced distance of 75 mm between the central bars makes it possible to use pots with a very small diameter (8 cm), avoiding the risk of smaller pans tipping over.
- The grates are made of RAAF enamelled cast iron (resistant to alkaline and acid products, fire and high temperatures).
- Double-crown burners and diffusers made of nickel-plated cast iron which guarantee an even distribution of heat from the flame to the base of the pans, even for large pans. This therefore prevents heat from building up in a specific point and optimises energy transfer to the product.
- Burners of different strengths to adapt to containers and for use with different foods:
 - 5.25 kW (Ø 100 mm),
 - 8.0 kW (Ø 120 mm),
- Burners are easy to position.

- 10 mm-thick cast iron plate with rounded corners, 400 x 580 mm, and shield with 210 mm diameter.
- 5.25 kW burner beneath fry top.
- Low-consumption pilot light and thermocouple located within the body of the burner for greater protection.
- Flexible stainless-steel gas pipes, facilitating internal manipulation in order to make repairs easier.
- Controls with a protective support base and system to prevent water infiltration.
- High-temperature enamelled cast iron flue protector which is flush with the grates therefore improving manoeuvrability, supporting larger containers and increasing the usable surface area.

OVEN

- Static oven size NG 2/1.
- Cooking chamber made entirely of stainless steel which makes cleaning easier and ensures greater hygiene.
- Trays are inserted sideways which improves manoeuvrability.
- Rails on three height levels to offer different cooking options.
- Rails with anti-tipping system to prevent trays from overturning.
- Thermostatic valve for temperature control (125 - 310 °C).
- Tubular stainless-steel burner with pilot light and thermocouple and piezoelectric ignition.
- Cast iron oven floor which guarantees better performance and uniform heat distribution.

- Fibreglass closing seal to improve the thermal efficiency of the oven and ensure its durability.
- Stamped oven frame and inner door, ensuring better oven closure.
- Detachable oven door to facilitate repairs.

Optional accessories (see accessories page at the end of the chapter)

- Frying plate to place on 5.25 kW burners
- Water column

MODEL	GAS	CODE	BURNERS		SOLID TOP 5,25 kW	OVEN 8,6 kW	TOTAL POWER (kW)	STANDS	DIMENSIONS	€
			5,25 kW	8 kW						
TOP										
C-G730-I	LPG	19073679	1	1	Left	-	18,50	-	800x730x290	-
	NG	19074769								
C-G730-D	LPG	19073680	1	1	Right	-	18,50	-	800x730x290	-
	NG	19074771								
C-G750	LPG	19070794	2	2	Centre	-	31,75	-	1200x730x290	-
	NG	19074772								
WITH OVEN										
C-G731-I	LPG	19073681	1	1	Left	1	27,1	-	800x730x850	-
	NG	19074773								
C-G731-D	LPG	19073682	1	1	Right	1	27,1	-	800x730x850	-
	NG	19074775								
C-G751	LPG	19074776	2	2	Centre	1	40,35	1	1200x730x850	-
	NG	19074777								

Gas solid tops



General characteristics

- Surface tops manufactured in 1.5 mm thick AISI-304 stainless steel.
- Laser-cut joints and automatic welding. Hidden screws.
- 10 mm-thick cast iron plate with rounded corners.
- Fry-top dimensions: 800 x 580 mm.
- Shield with 300 mm diameter.
- Refractory brick inside for improved heat use and distribution.
- Differentiated usage temperatures: 500 °C at the centre and 200 °C at the edges.
- Double-crown burner and diffuser made of cast iron which guarantee an even distribution of heat from the flame.
- Burner power: 8.4 kW.
- Low-consumption pilot light and thermocouple located within the body of the burner for greater protection.
- Flexible stainless-steel gas pipes, facilitating internal manipulation in order to make repairs easier.

- Controls with a protective support base and system to prevent water infiltration.
- High-temperature enamelled cast iron flue protector which is flush with the grates therefore improving manoeuvrability, supporting larger containers and increasing the usable surface area.
- Access to components from the front.

OVEN

- Easy-to-use NG 2/1 static oven with controls located on the upper panel for improved ergonomics.
- Cooking chamber made entirely of stainless steel which makes cleaning easier and ensures greater hygiene.
- Trays are inserted sideways which improves manoeuvrability.
- Rails on three height levels to offer different cooking options.
- Rails with anti-tipping system to prevent trays from overturning.

- Thermostatic valve for temperature control (125 - 310 °C).
- Tubular stainless-steel burner with pilot light and thermocouple and piezoelectric ignition.
- Cast iron oven floor which guarantees better performance and uniform heat distribution.
- Fibreglass closing seal to improve the thermal efficiency of the oven and ensure its durability.
- Stamped oven frame and inner door, ensuring better oven closure.
- Detachable oven door to facilitate repairs.

MODEL	GAS	CODE	SOLID TOP (mm)	BURNER 8,4 kW	OVEN		TOTAL POWER (kW)	DIMENSION S	€
					DIMENSIONS	POWER (kW)			
TOP									
C-G710	LPG	19070754	800x580	1	-	-	8,4	800x730x290	-
	NG	19073645							
WITH OVEN									
C-G711	LPG	19073088	800x580	1	NG-2/1	8,60	17	800x730x850	-
	NG	19074767							



Paella cookers



General characteristics

- Surface tops manufactured in 1.5 mm thick AISI-304 stainless steel.
- Laser-cut joints and automatic welding. Hidden screws.
- Double-crown burner with four rows of flames per crown, guaranteeing an even distribution of heat from the flame to the bottom of the paella.
- Low-consumption pilot light and thermocouple.
- Flexible stainless-steel gas pipes, facilitating internal manipulation in order to make repairs easier.
- Controls with a protective support base and system to prevent water infiltration.

- High-temperature enamelled cast iron flue protector which is flush with the grates therefore improving manoeuvrability, supporting larger containers and increasing the usable surface area.
- Access to components from the front.

PAELLA OVEN.

- 665 x 665 x 325 mm static paella oven with controls located on the upper panel.
- Cooking chamber made entirely of stainless steel which makes cleaning easier and ensures greater hygiene.
- Thermostatic valve for temperature control

(125 - 310 °C).

- Tubular stainless-steel burner in the rear part; operation with temperature gradient. Operation pilot light, piezoelectric ignition and thermocouple.
- Side-opening double door.

MODEL	GAS	CODE	BURNERS			OVEN		TOTAL POWER (kW)	DIMENSIONS	€
			OUTER	INNER	POWER (kW)	DIMENSIONS	POWER (kW)			
TOP										
C-GP710	LPG	19074804	450	330	27	-	-	27,00	800x730x290	-
	NG	19074806								
WITH OVEN										
C-GP711	LPG	19074808	450	330	27	665x665x325	7,30	34,30	800x730x850	-
	NG	19074811								

Electric cookers



General characteristics

- Pressed surface tops manufactured in 1.5 mm thick AISI-304 stainless steel, with rounded edges, designed to prevent spilled liquid from pans from entering the interior of the oven.
- Stamped surface top with rounded corners for easy cleaning.
- Laser-cut joints and automatic welding. Hidden screws.
- Cast iron hot plates,
 - ROUND, 223 Ø (2.6 kW), hermetically fixed to the stamped surface top
 - SQUARE, 230 x 230 (2.6 kW), hermetically fixed to the stamped surface top
- Power regulation via selector with 7 positions
- Protection against overheating for each plate.
- High-temperature enamelled cast iron flue protector.
- Access to components from the front
- Easy connection and compliant with health standards.







- Machines with IPX5 grade water protection.

OVEN

- Easy-to-use NG 2/1 static oven with controls located on the upper panel for improved ergonomics.
- Cooking chamber made entirely of stainless steel which makes cleaning easier and ensures greater hygiene.
- Trays are inserted sideways which improves manoeuvrability.
- Rails on three height levels to offer different cooking options.

- Rails with anti-tipping system to prevent trays from overturning.
- Thermostatic temperature control (125 - 310 °C).
- Heating through stainless steel heating elements with selector switch for operation of the upper and/or lower area.
- Cast iron oven floor which guarantees better performance and uniform heat distribution.
- Fibreglass closing seal to improve the thermal efficiency of the oven and ensure its durability.

- Stamped oven frame and inner door, ensuring better oven closure.
 - Detachable oven door to facilitate repairs.
- Voltage
- 400 V 3+N
 - For other voltages, consult the options at the end of the chapter.

MODEL	CODE	PLATES		OVEN		TOTAL POWER (kW)	NEUTRAL CABINET	DIMENSIONS	€
		(mm)	2,6 kW	DIMENSIONS	POWER (kW)				
ROUND PLATES									
TOP									
 C-E720	19068321	223	2	-	-	5,20	-	400x730x290	-
 C-E740	19067975	223	4	-	-	10,40	-	800x730x290	-
C-E760	19068322	223	6	-	-	15,60	-	1200x730x290	-
WITH OVEN									
 C-E741	19068498	223	4	NG-2/1	6	16,40	-	800x730x850	-
C-E761	19068645	223	6	NG-2/1	6	21,60	1	1200x730x850	-
SQUARE PLATES									
TOP									
 C-E720Q	19072313	230x230	2	-	-	5,20	-	400x730x290	-
 C-E740Q	19072312	230x230	4	-	-	10,40	-	800x730x290	-
WITH OVEN									
 C-E741Q	19071619	230x230	4	NG-2/1	6	16,40	-	800x730x850	-

Electric solid tops with 4 cooking zones



General characteristics

- Pressed surface tops manufactured in 1.5 mm thick AISI-304 stainless steel, with rounded edges, designed to prevent spilled liquid from pans from entering the interior of the oven.
- Stamped surface top with rounded corners for easy cleaning.
- Laser-cut joints, automatic welding and polishing. Hidden screws.
- "Solid top" model with four elements underneath the 16 mm-thick, 13CrMo4 plate, distributed so that they independently heat the four quarters of the plate. Solid-top dimensions: 720 x 455 mm.
- Power control with 7 positions for each heating element which makes it possible to work with different temperature gradients on the plate.
- 2.6 kW heating power for each heat point.
- Protection in the event of overheating of each heat source.
- Thermostat that activates the cooling fan for the electric components.

- Safety thermostat that ensures that the machine does not operate in the event of the overheating of the components.
- High-temperature enamelled cast iron flue protector.
- Access to components from the front.
- Easy connection and compliant with health standards.
- Machines with IPX5 grade water protection.

OVEN

- Easy-to-use NG 2/1 static oven with controls located on the upper panel for improved ergonomics.
- Cooking chamber made entirely of stainless steel which makes cleaning easier and ensures greater hygiene.
- Trays are inserted sideways which improves manoeuvrability.
- Rails on three height levels to offer different cooking options.
- Rails with anti-tipping system to prevent trays from overturning.

- Thermostatic temperature control (125 - 310 °C).
- Heating through stainless steel heating elements with selector switch for operation of the upper and/or lower area.
- Cast iron oven floor which guarantees better performance and uniform heat distribution.
- Fibreglass closing seal to improve the thermal efficiency of the oven and ensure its durability.
- Stamped oven frame and inner door, ensuring better oven closure.
- Detachable oven door to facilitate repairs.

VOLTAGE

- 400 V 3+N
- For other voltages, consult the options at the end of the chapter.

MODEL	CODE	SOLID TOP			OVEN		TOTAL POWER (kW)	DIMENSIONS	€
		MEASUREMENTS	COOKING AREAS	POWER (kW)	SIZE	POWER (kW)			
TOP									
C-E710	19068530	720 x 455	4	4X2,60	-	-	10,40	800x730x290	-
WITH OVEN									
C-E711	19068566	720 x 455	4	4X2,60	NG-2/1	6,00	16,40	800x730x850	-

Induction cookers



General characteristics

- 6 mm thick vitro ceramic glass, hermetically sealed in the 1.5 mm thick AISI-304 stainless steel surface top.
- Laser-cut joints and automatic welding. Hidden screws.
- Cooking areas demarcated by a circular Ø 260 mm screen print, with 5 kW power in each area, quick heating and ideal for à la carte service.
- Perfect control of cooking thanks to the energy regulator with 10 power levels which makes it possible to work at low temperatures for delicate recipes or at the highest temperature for quick service.
- Energy is only transferred to the area below the container and the rest of the vitro ceramic surface remains cold.
- It operates when it detects the presence of the container. When the container is removed, it stops heating.
- Consequently, it provides considerable energy savings (energy use is reduced by around 50% compared to gas burners).
- The working environment and atmosphere are more comfortable since the energy is concentrated at the base of the pan, heat radiation and dispersal are reduced and the cooking temperature is reached quickly.
- Safety against overheating. Error messages shown through flashing lights.
- High-temperature enamelled cast iron flue protector.
- Access to components from the front.
- Machines with IPX5 grade water protection.

VOLTAGE

- 400 V 3ph-
- For other voltages, consult the options at the end of the chapter.

MODEL	CODE	PLATES		TOTAL POWER (kW)	DIMENSIONS	€
		(Ø mm)	5,0 kW			
Induction panels						
C-I725	19057292	300	2	10,00	400x730x290	-
C-I745	19057293	300	4	20,00	800x730x290	-
Wok						
W-I705	19074716	300	1	5,00	400x730x290	-

Fry-tops







General characteristics

- Stamped surface tops manufactured in 1.5 mm thick AISI-304 stainless steel.
 - Laser-cut joints, automatic welding and polishing. Hidden screws.
 - 12 or 15 mm thick mild steel fry tops which are quick-heating and high power.
 - Models with smooth, grooved and mixed hot plates (2/3 smooth + 1/3 grooved).
 - Versions with 50-micron thick chrome surface for the three hot plate types.
 - Electrically heated models with stainless steel heating elements; thermostatic temperature control, between 100 and 300 °C.
 - Gas heated models with high efficiency burners (separate burners for whole-module models).
 - Gas heated models with thermostatic temperature control (between 100 and 300 °C) or operation via safety thermostat with thermocouple.
 - Burner ignition through electronic spark igniter. Therefore, the gas models do not need electricity for installation. With an access tube for manual ignition.
 - Whole-module fry tops have two separate heating areas.
 - Rapid reaction and recovery times of the fry-top temperature.
 - The fry tops are welded to the stamped surface top.
 - The stamped shell and its rounded edges and corners make cleaning much easier.
 - The fry top is tilted towards the front to make it easier to collect grease and liquids.
 - Fitted with an opening to collect cooking grease and a tray to store it which has capacity to store up to 2 litres depending on the model.
 - Optional anti-splash side and rear guards, easy to remove.
 - High-temperature enamelled cast iron flue protector.
 - Access to components from the front.
 - Machines with IPX5 grade water protection.
- Optional accessories (See accessories page at the end of the chapter)
- Scraper (*)
 - Anti-splash guard (in three parts to make cleaning easier).
- (*) The models with a chrome surface include the scraper as standard.
- Voltage of electric models
- 400 V 3+N. For other voltages, consult the options at the end of the chapter.



(*) Models with chrome surface, scraper included

Foodservice | Cooking Kore 700

MODEL	GAS	CODE	PLATES				TOTAL POWER (kW)	DIMENSIONS (mm)	€
			TYPE	AREAS	(mm)	dm ²			
GAS FRY TOP									
Max-min valve									
 FT-G705 V L	LPG	19068811	L	1	328x468	15,40	7,50	400x730x290	-
	NG	19074756							
 FT-G710 V L	LPG	19068518	L	2	728x468	34,10	15,00	800x730x290	-
	NG	19074757							
 FT-G705 V R	LPG	19073230	R	1	328x468	15,40	7,50	400x730x290	-
	NG	19076381							
FT-G710 V R	LPG	19073233	R	2	728x468	34,10	15,00	800x730x290	-
	NG	19074830							
FT-G710 V L+R	LPG	19074841	L+R	2	728x468	34,10	15,00	800x730x290	-
	NG	19074842							
Control by thermostat									
 FT-G705 L	LPG	19030765	L	1	328x468	15,40	7,50	400x730x290	-
	NG	19074843							
 FT-G710 L	LPG	19029450	L	2	728x468	34,10	15,00	800x730x290	-
	NG	19074844							
FT-G705 R	LPG	19074845	R	1	328x468	15,40	7,50	400x730x290	-
	NG	19073228							
FT-G710 R	LPG	19073231	R	2	728x468	34,10	15,00	800x730x290	-
	NG	19074758							
 FT-G710 L+R	LPG	19073232	L+R	2	728x468	34,10	15,00	800x730x290	-
	NG	19074846							
Control by thermostat and chromium hot-plate									
 FT-G705 C L	LPG	19073059	L/C	1	328x468	15,40	7,50	400x730x290	-
	NG	19073189							
 FT-G710 C L	LPG	19072626	L/C	2	728x468	34,10	15,00	800x730x290	-
	NG	19073222							
FT-G705 C R	LPG	19073210	R/C	1	328x468	15,40	7,50	400x730x290	-
	NG	19073221							
FT-G710 C R	LPG	19073211	R/C	2	728x468	34,10	15,00	800x730x290	-
	NG	19073223							
FT-G710 C L+R	LPG	19073212	L+R/C	2	728x468	34,10	15,00	800x730x290	-
	NG	19073224							
ELECTRIC FRYTOPS									
Control by thermostat									
 FT-E705 L	-	19058922	L	1	328x468	15,40	5,00	400x730x290	-
 FT-E710 L	-	19029261	L	2	728x468	34,10	10,00	800x730x290	-
FT-E705 R	-	19074847	R	1	328x468	15,40	5,00	400x730x290	-
 FT-E710 R	-	19074848	R	2	728x468	34,10	10,00	800x730x290	-
FT-E710 L+R	-	19073218	L+R	2	728x468	34,10	10,00	800x730x290	-
Control by thermostat and chromium hot-plate									
FT-E705 C R	-	19074850	R/C	1	328x468	15,40	5,00	400x730x290	-
 FT-E710 C R	-	19074852	R/C	2	728x468	34,10	10,00	800x730x290	-
 FT-E705 C L	-	19074849	L/C	1	328x468	15,40	5,00	400x730x290	-
FT-E710 C L	-	19074851	L/C	2	728x468	34,10	10,00	800x730x290	-
FT-E710 C L+R	-	19074853	L+R/C	2	728x468	34,10	10,00	800x730x290	-

Grills



General characteristics

- Stamped surface tops manufactured in 1.5 mm thick AISI-304 stainless steel
- Laser-cut joints and automatic welding. Hidden screws
- Mild steel grills, dismountable without the need for tools, in 170 mm wide sections.
- The mild steel grills are reversible, with different finishes on each side:
 - Tilted and grooved with ridges for meat
 - Horizontal and flat for fish and vegetables
- These grills reach a very high temperature (400 °C), meaning that the surface of the product is quickly sealed and inside it remains much juicier.
- The models with stainless steel grills are manufactured using "Z" shaped AISI-304 stainless steel slats to make cleaning easier.
- Fitted with an opening to collect cooking grease and a tray to store it.
- Machines are fitted with removable 130 mm high guards to prevent splashes, made of stainless steel.

ELECTRIC COUNTERTOP MODELS

- Groups of stainless steel covered elements upon which you can cook food directly (a group of 3 elements for half-sized module models and 2 groups for whole module models).
- Water tray for safety. It also allows an adequate level of humidity to be reached for optimum cooking conditions.

ELECTRIC FLOOR MODELS

- Groups of three stainless steel elements under the roasting rack, with radiant deflector (a group of three elements for half-sized module models, two groups for whole module models).
- Independent control for each group of elements via an energy regulator.
- The fat collection trays provide the option of adding water into them, and thanks to heat radiated from the gas burners or electrical elements, a low intensity steam is generated, causing the roast to be carried out in a humid environment.

GAS COUNTERTOP MODELS

- Groups of high-efficiency tube burners, (a group of two burners for half-sized module models, two groups for whole module models).
- Independent control for each group of burners via a safety valve with a thermocouple.
- Burners turned on using Piezo electric ignition.
- The burners heat ceramic stones that sit on a supporting rack, so that they can then heat food on the grill.

GAS FLOOR MODELS

- Groups of three high-efficiency tube burners, with a radiant deflector (a group of three burners for half-sized module models, two groups for whole module models).

- Independent control for each group of burners via a safety valve with a thermocouple.
- Burners turned on using electric multi-spark ignition. With an access tube for manual ignition.
- The fat collection trays provide the option of adding water into them, and thanks to heat radiated from the gas burners or electrical elements, a low intensity steam is generated, causing the roast to be carried out in a humid environment.

Optional accessories: (See accessories page at the end of the chapter)



Special scraper with two profiles for models with cast iron grill.

Special scraper adapted for models with stainless steel grill.

MODEL	GAS	CODE	GRIDS					TOTAL POWER (kW)	DIMENSIONS (mm)	€
			TYPE	AREAS	QUANTITY	(mm)	dm ²			
GAS GRILLS										
Countertop										
B-G705 I	LPG	19074781	Inox	1	1	515x344	17,72	8,10	400x730x290	-
	NG	19074782								
B-G705	LPG	19074120	Mild steel	1	2	515x172	17,72	8,10	400x730x290	-
	NG	19074779								
B-G710 I	LPG	19072463	Inox	2	2	515x344	35,43	16,20	800x730x290	-
	NG	19074784								
B-G710	LPG	19067288	Mild steel	2	4	515x172	35,43	16,20	800x730x290	-
	NG	19074783								
Ground										
B-G7051 I	LPG	19078755	Inox	1	1	515x344	17,72	8,1	400x730x850	-
	NG	19081688								
B-G7051	LPG	19078909	Mild steel	1	2	515x172	17,72	8,1	400x730x850	-
	NG	19081687								
B-G7101 I	LPG	19078771	Inox	2	2	515x344	35,43	16,2	400x730x850	-
	NG	19081689								
B-G7101	LPG	19078905	Mild steel	2	4	515x172	35,43	16,2	400x730x850	-
	NG	19081700								
Electric grills										
Countertop										
B-E705 I	-	19074788	Inox	1	1	270x430	11,61	4,08	400x730x290	-
B-E710 I	-	19070294	Inox	2	1	545x430	23,44	8,16	800x730x290	-



New

Pasta cookers



General characteristics

- Surface tops manufactured in 1.5 mm thick AISI-304 stainless steel.
- Laser-cut joints, automatic welding and polishing. Hidden screws.
- 1.5 mm thick AISI-316L stainless steel wells built into the surface top.
- 2 well sizes (they can be used with different positions of baskets of different sizes):
 - GN-2/3 wells, with 26 litre capacity
 - GN-1/1 wells, with 40 litre capacity
- The well is filled through the inlet solenoid valve with a two-position switch: average and high-speed filling.
- Well drainage through a mechanical ball valve which is resistant to high temperatures and has a safety overflow.

- Automatic safety system to stop the current if the water runs out.
- Controls with a protective support base and system to prevent water infiltration.
- Machines with IPX5 grade water protection.

GAS MODELS

- High-performance stainless-steel burner located outside of the well with a combustion chamber that enables heating of the base and sides of the well (up to the minimum filling level)
- Burner ignition through electronic spark igniter. With an access tube for manual ignition
- Heating controlled through safety valve.

ELECTRIC MODELS

- AISI 304 stainless-steel heating elements located inside the well to directly heat the water.
- Heating controlled through energy regulator.
- Voltage: 400 V 3+N. For other voltages, consult the options at the end of the chapter.

Standard provision

- 26 L models: 2 x 1/3 baskets per well
- 40 L models: 3 x 1/3 baskets per well

Optional accessories: (See accessories page at the end of the chapter)

- 6 x 1/6 square baskets kit
- 6 x 1/6 round baskets kit
- 4 x 1/4 baskets kit
- 2 x 1/2 baskets kit

MODEL	GAS	CODE	QUANTITY	WELL		TOTAL POWER (kW)	DIMENSIONS (mm)	€
				SIZE	BASKETS (1/3)			
Gas pasta cookers								
CP-G7126	LPG	19071621	1	NG-2/3	2	10,00	400x730x850	-
	NG	19074728						
CP-G7226	LPG	19071360	2	NG-2/3	4	20,00	800x730x850	-
	NG	19074729						
CP-G7140	LPG	19074764	1	NG-1/1	3	16,50	400x730x850	-
	NG	19074770						
CP-G7240	LPG	19074774	2	NG-1/1	6	33,00	800x730x850	-
	NG	19074778						
Electric pasta cookers								
CP-E7126	-	19071569	1	NG-2/3	2	9,00	400x730x850	-
CP-E7226	-	19072437	2	NG-2/3	4	18,00	800x730x850	-
CP-E7140	-	19074747	1	NG-1/1	3	12,00	400x730x850	-
CP-E7240	-	19074780	2	NG-1/1	6	24,00	800x730x850	-

Boiling pans



General characteristics

- Surface tops manufactured in 1.5 mm thick AISI-304 stainless steel.
- Laser-cut joints, automatic welding and polishing. Hidden screws.
- Lid with a front handle designed to prevent burns. Diagonal 70° opening.
- Drainage hole to redirect possible liquid spillages.
- 80-litre AISI-304 stainless-steel well built into the surface top using robotic welding, with a 2 mm-thick AISI 316L stainless steel well base.
- Well filled with cold or hot water through solenoid valves activated by a single switch located on the front panel.
- Well drainage through G1-1/2" UNI ISO 228 safety valve with athermic handle, safe and effortless.
- Filter for well drainage made of AISI-304 stainless-steel which is robust, reliable and easy to remove.

- Controls with a protective support base and system to prevent water infiltration.
- Indicator light to show when the machine is connected and when it is heating.
- IPX5 level protection.

DIRECT FLAME MODELS

- High-performance stainless-steel tubular burner with optimised combustion and sequential operation. Controlled by an energy regulator which enables slower cooking.
- Heating of the burner at the base of the boiling pan is evenly distributed, resulting in gradual heating of the contents of the well.
- Possibility of regulating heating of the burner since there are different levels of power.

- Burner is lit by spark ignition. Indirect flame models or bain-marie
- Bain-marie chamber surrounding the well with an automatic filling system
- Automatic control of the level of the chamber with three-way safety system: pressure switch to control pressure in the chamber, limiter thermostat to prevent overheating of the chamber and overpressure safety valve.
- Automatic clearing of the chamber.
- Heating at the base of the boiling pan acts on the water in the surrounding chamber so that the saturated steam produced at a temperature of 107 °C evenly heats the base and sides of the well.

GAS MODELS

- High-performance stainless-steel tubular burner with optimised combustion.
- Controlled by energy regulator and pressure switch enabling lower energy and water use.
- Burner is lit by spark ignition.

ELECTRIC MODELS

- Heating through heating elements located in the lower part of the bain-marie chamber.
- Heating controlled through energy regulator and pressure switch.
- Voltage: 400 V 3+N. For other voltages, consult the options at the end the chapter.

MODEL	HZ	CODE		TANKS		TOTAL POWER (kW)	DIMENSIONS (mm)	€
		LPG	NG	D X H	VOLUME (L)			
GAS BOILING PANS								
Direct fire								
M-G710	50	19061151	19074790	Ø420x605	80	17,00	800x730x850	-
	60	19074792	19074793					
Indirect heating or bain marie								
M-G710 BM	50	19066324	19074807	Ø420x605	80	17,00	800x730x850	-
	60	19074809	19074810					
ELECTRIC BOILING PANS								
Indirect heating or bain marie								
M-E710 BM	-	19067268		Ø420x605	80	9,00	800x730x850	-

Fryers



General characteristics

- Surface tops manufactured in 1.5 mm thick AISI-304 stainless steel.
- Laser-cut joints, automatic welding and polishing Hidden screws.
- 8 L electric countertop models and 15 L gas and electric floor models.
- Wells built into the surface top with robotic welding and polishing.
- Cold area in the lower part of the well which helps to preserve the characteristics and quality of the oil used for longer.
- Thermostatic temperature control, between 60 and 200 °C.
- Safety thermostat in all models.
- Fitted with individual lids for each well.
- Drainage of oil from the well through a mechanical ball valve which is robust, reliable and resistant to high temperatures. For 8 L models, the discharge control is

located in the control panel.
- High power machines that heat up quickly and have a high power - litre ratio (up to 1.00 kW/litre).

GAS MODELS

- Gas models with three longitudinal heat transfer tubes built into the well.
- High-efficiency gas burners
- Flue flush with the rest of the machines thanks to the perfect combustion achieved.

ELECTRIC MODELS

- Electric models with AISI 304 stainless steel heating elements located inside the well which can be tilted by over 90° to ensure perfect cleaning.

- Voltage: 400 V 3+N. For other voltages, consult the options at the end of the chapter.

Baskets provided:

- 8 L fryers: 1 small basket per well (125 x 280 x 100 mm)
- 15 L fryers: 1 large basket per well (250 x 280 x 100 mm).

Optional accessories:

- (See accessories page at the end of the chapter)
- 15 L fryers: small basket (125 x 280 x 100 mm).

MODEL	HZ	CODE		TANKS	TOTAL POWER (kW)	DIMENSIONS (mm)	€		
		LPG	NG						
				QUANTITY	VOLUME (L)	BASKETS			
GAS FRYERS									
F-G7115	50	19074143	19074785	1	1x15	1 large	15,00	400x730x850	-
	60	19074786	19074787						
F-G7215	50	19074791	19074794	2	2x15	2 larges	30,00	800x730x850	-
	60	19074795	19074796						
ELECTRIC FRYERS									
F-E7108	-	19072100		1	1x8	1 small	6,00	400x730x290	-
F-E7208	-	19072444		2	2x8	2 smalls	12,00	800x730x290	-
F-E7115	-	19071300		1	1x15	1 large	12,00	400x730x850	-
F-E7215	-	19071455		2	2x15	2 larges	24,00	800x730x850	-

Chips scuttle



General characteristics

- Half-module electrically heated machine, heated by infrared light located at the back of the machine which is activated by the ON/OFF switch.
- Surface top manufactured in 1.5 mm thick AISI-304 stainless steel.
- Laser-cut joints, automatic welding and polishing. Hidden screws.
- Well built into the surface top with capacity for 150 mm high Gastronorm NG-1/1 recipient.
- Fitted with a removable, perforated, stainless-steel filter which is tilted to remove excess oil from the fryer.
- Controls with a system to prevent water infiltration, IPX5 grade protection.

MODEL	CODE	WELLS	TOTAL POWER (kW)	DIMENSIONS (mm)	€
 MF-E705	19072598	NG-1/1	1,00	400x730x290	-

Tilting bratt pans





General characteristics

- Laser-cut joints, automatic welding and polishing. Hidden screws.
- Lever system to raise the well. The well can be raised until it is vertical to completely drain it.
- Entire machine structure made of stainless steel.
- Well designed with rounded corners and no edges, with a large opening for unloading to facilitate all cooking and cleaning operations.
- The great thickness of the well base (10 mm) guarantees even heat distribution.
- Well filled with water through a solenoid valve which is operated by a switch on the front of the machine. The filling pipe is located at the back of the machine.
- Double-walled lid with a draining rack at the back to redirect condensation water towards the well interior.
- The closed lid is the same height as surface tops of the range and since it does not require any protruding element or reinforcement, it can be used as a worktop.
- Compensation system to prevent sharp falls.
- Front access lid handle.
- Electrically heated using stainless steel heating elements located below the base of the well.
- Gas heating with high-efficiency stainless steel burners made of four tubes which are activated and controlled by a safety valve with a thermocouple.
- Thermostatic temperature control of the well floor, between 50 and 300 °C.
- Heating through burner tubes or electric heating elements located in the base of the well itself which, together with the great thickness of the well base, ensure maximum uniformity in heat distribution in all cases, guaranteeing consistent cooking.

Voltage of electric models

- 400 V 3+N. For other voltages, consult the options at the end of the chapter.

MODEL	HZ	CODE		RAISING SYSTEM	TANK TYPE	CAPACITY (L)	SURFACE		TOTAL POWER (kW)	DIMENSIONS (mm)	€
		LPG	NG				(mm)	(dm ²)			
Gas tilting bratt pans											
 SB-G710	50-60	19058021	19074854	Manual	Inox	60	734x464	34	15	800x730x850	-
Electric tilting bratt pans											
 SB-E710	-	19057670		Manual	Inox	60	734x464	34	10	800x730x850	-

Bain maries



General characteristics

- Surface tops manufactured in 1.5 mm thick AISI-304 stainless steel.
- Laser-cut joints, automatic welding and polishing. Hidden screws.
- Wells that can be used with different types of Gastronorm containers of different sizes, 150 mm high, and with the following dimensions:
- Half-module: NG-1/1, with 17 litre capacity.
- Whole-module: NG-2/1, with 30 litre capacity.
- AISI-304 stainless steel wells built into the surface top.
- Gravity drainage: simple well drainage

- through removal of the overflow pipe.
- Thermostatic temperature control of the water, between 30 and 90 °C.
- Controls with a protective support base and system to prevent water infiltration (IPX5 protection).

GAS MODELS

- Insulated combustion chamber which reduces heating of the components.
- High-efficiency stainless steel burner located outside the well.
- Pilot light via piezo ignition.
- Tube for alternative manual ignition.

- Does not require electrical installation.

ELECTRIC MODELS

- AISI 304 stainless steel heating elements located outside the well.
- Safety thermostat.

Standard provision:

- 2 crossbars to support Gastronorm containers.
- Containers not included.

Accessory (See accessories page at the end of the chapter)

- Filling valve.

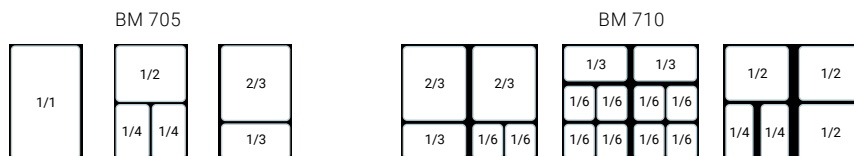

MODEL	GAS	CODE	TANK		TOTAL POWER (kW)	DIMENSIONS (mm)	€
			SIZE	VOLUME (L)			
Gas Bain maries							
BM-G705	LPG	19069826	NG-1/1	17	3,20	400x730x290	-
	NG	19073060					
BM-G710	LPG	19071631	NG-2/1	30	6,40	800x730x290	-
	NG	19074727					
Electric Bain maries							
BM-E705	-	19071437	NG-1/1	17	2,00	400x730x290	-
BM-E710	-	19071800	NG-2/1	30	6,00	800x730x290	-







Neutral elements



General characteristics

- Surface top manufactured in 1.5 mm thick AISI-304 stainless steel.
- Laser-cut joints and automatic welding.
- Hidden screws.
- Machines designed to attach to a filling valve or water column at the back.
- High-temperature enamelled cast iron flue trim.

	MODEL	CODE	DRAWERS		DIMENSIONS (mm)	€
			QUANTITY	(mm)		
	EN-7025	19076626	-	-	200x730x290	-
	EN-705	19056719	-	-	400x730x290	-
	EN-710	19056790	-	-	800x730x290	-
	EN-705 C	19068696	1	300x590x105 (válido GN-1/1)	400x730x290	-
	EN-710 C	19068697	1	700x590x105	800x730x290	-



* It can only be placed in central blocks or murals without verticality.

Stands



General characteristics

- Manufactured with a solid structure in AISI-304 stainless steel.
- Hidden screws.
- Can be quickly connected to serve as a support for surface top elements from the KORE 700 range.
- Can be used as an open storage element.
- Designed to be attached to optional kits:
 - Doors.
 - 2 NG drawers (for MB-705 model).
 - Rails for NG containers, 5 levels (for MB-705 model, compatible with the doors kit).

MODEL	CODE	DOORS IN OPTION (NOT INCLUDED)	DRAWERS	GUIDES (5 LEVELS)	DIMENSIONS (mm)	€
MB-7025	19076625	-	-	-	200x660x560	-
 MB-705	19057229	1	-	-	400x660x560	-
MB-705 C	19067227	-	2	-	400x660x560	-
MB-705 G	19074825	1	-	1	400x660x560	-
 MB-710	19057290	2	-	-	800x660x560	-
 MB-715	19057291	3	-	-	1200x660x560	-

Kits for stands





CODE	DESCRIPTION	€
 19040900	DOOR KIT: The kit allows the door to be reversible, so that it can be assembled opening to the left or to the right. The number of doors depends on the stand to which they are to be mounted.	-

Refrigerated stands



General characteristics

- Sealed compressor with ventilated condenser.
 - Copper pipe evaporator with aluminum wings.
 - 50 mm injected polyurethane insulation with a density of 40kg/m³.
 - BP models with panoramic door opening and automatic closing device with stay open feature above 90°.
 - Height adjustable stainless-steel legs (from 130mm to 190mm) allows adjusting the overall height of the counter from 580 to 640mm.
 - Forced air refrigeration system.
 - Working temperature: -2 °C, +8 °C, at room temperature of 38 °C.
 - Climate Class 4.
 - Electronic temperature and defrosting control and display.
 - BP model with doors and B model with GN 2/3 holding capacity drawers.
 - BH model with a full-length flat drawer with 2XGN2/3 holding capacity and equipped with 5 crosspieces to support different combinations of GN containers.
- Options:
- Kit of 6 castors (2 with brakes). Factory fitted.
 - Heated door frame to avoid condensation in high humidity environments.
 - Locks on doors.
 - 60Hz.

MODEL	COOLANT	HZ.	CODE	N. DOORS AND DRAWERS	ENERGY EFFICIENCY CLASS	GROSS CAPACITY (L)	ANNUAL ENERGY CONSUMPTION (KW-H)	ELECTRIC POWER(W)	DIMENSIONS (MM)	€
MODELS WITH DOORS										
 EMFP7-120 BP	R-290	50	19074945	2	C	110	657	250	1200x630x590	-
 EMFP7-160 BP	R-290	50	19076353	3	C	169	1113	250	1.600x630x590	-
MODELS WITH 2/3 DRAWERS										
 EMFP7-120 B	R-290	50	19074943	2 x GN 2/3	C	110	657	250	1200x630x590	-
 EMFP7-160 B	R-290	50	19076352	3 x GN 2/3	C	169	1113	250	1.600x630x590	-
MODELS WITH FULL LENGTH FLAT DRAWERS										
 EMFP7-120 BH	R-290	50	19075072	2 x GN 4/3	c	110	777	250	1200x630x590	-

Kore 700 blocks





Central or wall block

Non-vertical blocks







Finishings

TYPE	BLOCK TYPE	DESCRIPTION	CODE	€
Single smooth panel for machinery 	CENTRAL OR WALL BLOCK	Left smooth panel	19081813	-
		Right smooth panel	19081814	-
		Left smooth panel for block with a tilting bratt pan on the end.	19081815	-
		Right smooth panel for block with a tilting bratt pan on the end.	19081816	-
		Double wall trimming for each side block 	CENTRAL BLOCK	Side trim for Kore 700 block
		Side trim for mixed Kore 900 + Kore 700 block Left Kore 700 and Right Kore 900.	19081827	-
		Side trim for mixed Kore 900 + Kore 700 block Left Kore 700 and Right Kore 900.	19081828	-
	WALL BLOCK	Left side trim	19081821	-
		Right side trim	19081822	-

*You cannot put trimming on if a tilting bratt pan is attached to the end.

Burner base

TIPE	DESCRIPTION	CODE	€
GAS* 	Gas burner base 1 M	19081800	-
	Gas burner base 1,5 M	19081789	-
	Gas burner base 2 M	19081788	-
	Gas burner base 2,5 M	19081787	-
	Gas burner base de 3 M	19081786	-
	Gas burner base 3,5 M	19081785	-
	Gas burner base 4 M	19081784	-
	Gas burner base 4,5 M	19081783	-
	Gas burner base 5 M	19081782	-
	ELECTRIC 	Electric burner base 1 M	19081809
Electric burner base 1,5 M		19081808	-
Electric burner base 2 M		19081807	-
Electric burner base 2,5 M		19081806	-
Electric burner base 3 M		19081805	-
Electric burner base 3,5 M		19081804	-
Electric burner base 4 M		19081803	-
Electric burner base 4,5 M		19081802	-
Electric burner base 5 M		19081801	-



Non-vertical blocks

Supports

TIPE	DESCRIPTION	CODE	€
 Neutral elements	Standard	19075224	-
	Standard with plug	19075225	-
	Standard with tap	19075226	-
 For machinery*	For optima oven	19075227	-
	For salamander	19075228	-





* Not suitable for suspended wall blocks. Must be placed on neutral parts measuring 1 M on both sides.

Racks and shelves

TIPE	TIPE SOPORTE	LARGURA BLOQUE					
		2M	2 1/2M	3M	3 1/2M	4M	4 1/2M
SUSPENDED CENTRAL BLOCK							
 Rack	For two standard elements	19075398 -	19075399 -	19075400 -	19075401 -	19075402 -	19075403 -
	For 1 standard support + 1 machinery support	19075405 -	19075406 -	19075407 -	19075408 -	19075409 -	19075420 -
	For 2 machinery supports	- -	19075423 -	19075424 -	19075425 -	19075426 -	19075427 -
 Shelf	For two standard elements	19075436 -	19075437 -	19075438 -	19075439 -	19075440 -	19075441 -
	For 1 standard support + 1 machinery support	19075443 -	19075444 -	19075445 -	19075446 -	19075447 -	19075448 -
	For 2 machinery supports	- -	19075453 -	19075454 -	19075455 -	19075456 -	19075457 -
SUSPENDED WALL BLOCK							
 Rack	For two standard elements	19075429 -	19075430 -	19075431 -	19075432 -	19075433 -	19075434 -
 Shelf	For two standard elements	19075459 -	19075460 -	19075461 -	19075462 -	19075463 -	19075464 -





Finishings

TIPE	DESCRIPTION	CODE	€
CENTRAL BLOCK			
Single smooth panel for machinery 	Left smooth panel	19081760	-
	Right smooth panel	19081761	-
	Left smooth panel for block with a tilting bratt pan on the end	19081762	-
	Right smooth panel for block with a tilting bratt pan on the end	19081763	-
Double trim for each side block * 	Side trim for Kore 700 central block	19081775	-
	Side trim for mixed Kore 900 + Kore 700 central block: Left Kore 700 right Kore 900	19081779	-
	Side trim for mixed Kore 900 + Kore 700 central block: Right Kore 700 left Kore 900	19081780	-
WALL BLOCK			
Single smooth panel for machinery 	Left smooth panel	19081755	-
	Right smooth panel	19081757	-
	Left smooth panel for block with a tilting bratt pan on the end	19081758	-
	Right smooth panel for block with a tilting bratt pan on the end	19081759	-
Double trim for each side block * 	Left side trim	19081773	-
	Right side trim	19081774	-

*You cannot put trimming on if a tilting bratt pan is attached to the end.

Burner base

TIPE	DESCRIPTION	CODE	€
GAS* 	Gas burner base 1 M	19081800	-
	Gas burner base 1,5 M	19081789	-
	Gas burner base 2 M	19081788	-
	Gas burner base 2,5 M	19081787	-
	Gas burner base de 3 M	19081786	-
	Gas burner base 3,5 M	19081785	-
	Gas burner base 4 M	19081784	-
	Gas burner base 4,5 M	19081783	-
	Gas burner base 5 M	19081782	-
ELÉCTRICO 	Electric burner base 1 M	19081809	-
	Electric burner base 1,5 M	19081808	-
	Electric burner base 2 M	19081807	-
	Electric burner base 2,5 M	19081806	-
	Electric burner base 3 M	19081805	-
	Electric burner base 3,5 M	19081804	-
	Electric burner base 4 M	19081803	-
	Electric burner base 4,5 M	19081802	-
	Electric burner base 5 M	19081801	-

*If one appliance on the block uses gas, select gas burners bases.

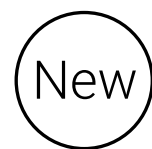

Suspended central or wall block

Non-vertical blocks



Each kit below contains:

- Support modules built with 4 mm AISI-304 stainless steel frames.
- Support arms to hold the machines in place, made from AISI-304 stainless steel.
- Rear supports also made from AISI-304.
- Smooth closure panels at the side as well as the front (if you want a finish with side trim instead of a flat panel, request the kit and check).
- Supporting feet.

*All these parts will be provided after receiving the machinery plan.

TIPE	DESCRIPTION	CODE	€
ASSEMBLY KITS WITH SMOOTH PANEL FINISH.			
Cantilever central block	Kore central cantilever kit 1,5 M	19076835	-
	Kore central cantilever kit 2 M	19076836	-
	Kore central cantilever kit 2,5 M	19076837	-
	Kore central cantilever kit 3 M	19076838	-
	Kore central cantilever kit 3,5 M	19076839	-
	Kore central cantilever kit 4 M	19076840	-
	Kore central cantilever kit 4,5 M	19076841	-
	Kore central cantilever kit 5 M	19076842	-
	Kore central cantilever kit 5,5 M	19076843	-
	Kore central cantilever kit 6 M	19076844	-
Cantilever wall block	Kore central cantilever kit 1,5 M	19076825	-
	Kore central cantilever kit 2 M	19076826	-
	Kore central cantilever kit 2,5 M	19076827	-
	Kore central cantilever kit 3 M	19076828	-
	Kore central cantilever kit 3,5 M	19076829	-
	Kore central cantilever kit 4 M	19076830	-
	Kore central cantilever kit 4,5 M	19076831	-
	Kore central cantilever kit 5 M	19076832	-
	Kore central cantilever kit 5,5 M	19076833	-
	Kore central cantilever kit 6 M	19076834	-
SIDE TRIM FINISHING			
Cantilever central or wall block	Kit to provide a cantilever block with lateral supports and side trim*	Consult	

* Add to the kit order.



Vertical blocks

Supports

TIPE	DESCRIPTION	CODE	€
 Neutral elements	Standard	19075392	-
	Standard with plug	19075393	-
	Standard with tap	19075394	-
 Para maquinaria*	Para horno optima	19075395	-
	Para salamandra	19075396	-

* Not suitable for suspended wall blocks. Must be placed on neutral parts measuring 1 M on both sides.

Racks and shelves

TIPE	TIPE SOPORT	LARGURA BLOQUE					
		2M	2 1/2M	3M	3 1/2M	4M	4 1/2M
SUSPENDED CENTRAL BLOCK							
 Rack	For two standard elements	19075398 -	19075399 -	19075400 -	19075401 -	19075402 -	19075403 -
	For 1 standard support + 1 machinery support	19075405 -	19075406 -	19075407 -	19075408 -	19075409 -	19075420 -
	For 2 machinery supports	- -	19075423 -	19075424 -	19075425 -	19075426 -	19075427 -
 Shelf	For two standard elements	19075436 -	19075437 -	19075438 -	19075439 -	19075440 -	19075441 -
	For 1 standard support + 1 machinery support	19075443 -	19075444 -	19075445 -	19075446 -	19075447 -	19075448 -
	For 2 machinery supports	- -	19075453 -	19075454 -	19075455 -	19075456 -	19075457 -
SUSPENDED WALL BLOCK							
 Rack	For two standard elements	19075429 -	19075430 -	19075431 -	19075432 -	19075433 -	19075434 -
 Shelf	For two standard elements	19075459 -	19075560 -	19075561 -	19075562 -	19075563 -	19075564 -



Bridge block

Finishings

Each kit below contains:

- Support modules built with 4 mm AISI-304 stainless steel frames.
- Support arms to hold the machines in place, made from AISI-304 stainless steel.
- Rear supports also made from AISI-304.

- Smooth closure panels at the side as well as the front (if you want a finish with side trim instead of a flat panel, request the kit and check).
- Supporting feet.
- * All these parts will be provided after receiving the machinery plan.

TYPE	DESCRIPTION	CODE	€
ASSEMBLY KITS WITH SMOOTH PANEL FINISH.			
Cantilever central block	Kore central cantilever kit 1,5 M	19076835	-
	Kore central cantilever kit 2 M	19076836	-
	Kore central cantilever kit 2,5 M	19076837	-
	Kore central cantilever kit 3 M	19076838	-
	Kore central cantilever kit 3,5 M	19076839	-
	Kore central cantilever kit 4 M	19076840	-
	Kore central cantilever kit 4,5 M	19076841	-
	Kore central cantilever kit 5 M	19076842	-
	Kore central cantilever kit 5,5 M	19076843	-
	Kore central cantilever kit 6 M	19076844	-
Cantilever wall block	Kore central cantilever kit 1,5 M	19076825	-
	Kore central cantilever kit 2 M	19076826	-
	Kore central cantilever kit 2,5 M	19076827	-
	Kore central cantilever kit 3 M	19076828	-
	Kore central cantilever kit 3,5 M	19076829	-
	Kore central cantilever kit 4 M	19076830	-
	Kore central cantilever kit 4,5 M	19076831	-
	Kore central cantilever kit 5 M	19076832	-
	Kore central cantilever kit 5,5 M	19076833	-
	Kore central cantilever kit 6 M	19076834	-
SIDE TRIM FINISHING			
Cantilever central or wall block	Kit to provide a cantilever block with lateral supports and side trim*	Consult	-

* Add to the kit order.



Bridge block



Finishings

Each kit below contains:

- Support modules built with 4 mm AISI-304 stainless steel frames.
- Support arms to hold the machines in place, made from AISI-304 stainless steel.
- Rear supports also made from AISI-304.

- Smooth closure panels at the side as well as the front (if you want a finish with side trim instead of a flat panel, request the kit and check).

- Supporting feet.

*All these parts will be provided after receiving the machinery plan.

TYPE	DESCRIPTION	CODE	€
ASSEMBLY KITS			
	Bridge kit for Kore block 1 M	19044954	-
	Bridge kit for Kore block 1,5 M	19044955	-
	Bridge kit for Kore block 2 M	19044956	-
	Bridge kit for Kore block 2,5 M	19044957	-
	Bridge kit for Kore block 3 M	19044958	-
	Bridge kit for Kore block 3,5 M	19044959	-
	Bridge kit for Kore block 4 M	19044960	-
EXTERNAL TERMINATION			
Single smooth panel for machinery	Left smooth panel	19081813	-
	Right smooth panel	19081814	-
	Left smooth panel for block with a tilting bratt pan on the end	19081815	-
	Right smooth panel for block with a tilting bratt pan on the end	19081816	-
Double trim for each side block *	Left side trim	19081821	-
	Right side trim	19081822	-
INTERIOR TERMINATION			
	Interior individual panel for bridge block	19081993	-

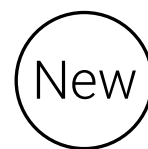



Burner base

TYPE	DESCRIPTION	CODE	€
GAS	Gas burner base 0,5 M	19081990	-
	Gas burner base 1 M	19081800	-
	Gas burner base 1,5 M	19081789	-
	Gas burner base 2 M	19081788	-
	Gas burner base 2,5 M	19081787	-
	Gas burner base de 3 M	19081786	-
	Gas burner base 3,5 M	19081785	-
	Gas burner base 4 M	19081784	-
	Gas burner base 4,5 M	19081783	-
	Gas burner base 5 M	19081782	-
	ELECTRIC	Electric burner base 0,5 M	19081991
Electric burner base 1 M		19081809	-
Electric burner base 1,5 M		19081808	-
Electric burner base 2 M		19081807	-
Electric burner base 2,5 M		19081806	-
Electric burner base 3 M		19081805	-
Electric burner base 3,5 M		19081804	-
Electric burner base 4 M		19081803	-
Electric burner base 4,5 M		19081802	-
Electric burner base 5 M		19081801	-

*If one appliance on the block uses gas, select gas burners bases.

Accessories



Cooker accessories

	DESCRIPTION	CODE	€
	KORE water column kit left	19076661	-
	KORE water column kit right	19076662	-
	Kore smooth fry-top (350 x 300 mm)	19078476	-
	Wok pan adaptor	19078477	-
	Kit 2 brass transmitters (1 x 5.25 kW + 1 x 8 Kw) C-G720	19084557	-
	Kit 2 high power brass transmitters (1 x 8 kW + 1 x 10.2 Kw) C-G720 H	19084558	-
	Kit 4 brass transmitters (2 x 5.25 kW + 1 x 8 kW + 1 x 10.2 kW) C-G740, C-G741, C-GE741	19084559	-
	Kit 4 high power brass transmitters (3 x 8 kW + 1 x 10.2 kW) C-G750, C-G751	19084571	-
	Kit 6 brass transmitters (3 x 5.25 kW + 2 x 8 kW + 1 x 10.2 kW) C-G740 H, C-G741 H, C-GE741 H	19084570	-
	Kit 6 high power brass transmitters (5 x 8 kW + 1 x 10.2 kW) C-G760, C-G761, C-GB761, C-GB761 R	19084572	-
	Kit 6 difusores de latón alta potencia (6 x 8 kW) C-G760H, C-G761 H, C-GB761 H, C-GB761 RH	19084573	-

Fryer accessories

	DESCRIPTION	CODE	€
	15L small fryer basket	19078478	-

Fry-top accessories

	DESCRIPTION	CODE	€
	KORE 0.5M fry-top guard	19078921	-
	KORE 1M fry-top guard	19078920	-
	Fry-top scraper	19045083	-

Accessories for charcoals

	DESCRIPTION	CODE	€
	KORE charcoal scraper - FE Grill	19045084	-
	KORE charcoal scraper - Stainless steel Grill	19058313	-

Bain marie accessories

	DESCRIPTION	CODE	€
	KORE filling tap kit	19074221	-

Machines with wheels

	DESCRIPTION	CODE	€
	KORE kit of 4 wheels	19044983	-
	KORE kit of 2 fixed wheels	19044985	-

Pasta cooker accessories

DESCRIPTION	CODE	€
 Pasta cooker baskets kit 40 L – 6x1/6 square	19036341	-
 Pasta cooker baskets kit 40 L – 6x1/6 round	19036342	-
 Pasta cooker baskets kit 40 L – 4x1/4	19036344	-
 Pasta cooker baskets kit 40 L – 2x1/2	19036340	-
 Pasta cooker baskets kit 26 L – 4x1/6 square	19076807	-
 Pasta cooker baskets kit 26 L – 4x1/6 round	19076809	-

Tall chimney kit

DESCRIPTION	CODE	€
Tall chimney kit 1/4 M Kore 900 appliances	19081001	-
 Tall chimney kit 1/2 M Kore 900 appliances	19080999	-
Tall chimney kit 1 M Kore 900 appliances	19080990	-
Tall chimney kit 1 1/4 M Kore 900 appliances	19081000	-

* Can be installed in all appliances except electric fryers.

Transformations to other voltages - "marine" version (*)

Machines destined for ships, 440 V - 3 Phase, should be requested in the order indicating these data:

- Code for the standard appliance 400 V 3+N.

- Note for assembly 440 V - 3 phases without neutral.

DESCRIPTION	CODE	€
MARINE - Tilting bratt pans and boiling pans - Transformation for ship - 440 III	19057294	-
MARINE - Other appliances - Transformation for ship - 440 III	(*)	-
230 III - Transformation to 230 V three-phase without neutral	(*)	-
230 1N - Transformation to 230 V single-phase	(*)	-

(*): Consult the existence of a version for this voltage



The answer to
all the cooking needs
of small establishments.



Find out more!



Access the website



Sales brochure



600 Series

Open burner gas cookers	082
Glass ceramic cookers	082
Fry-tops	083
Pasta cooker.....	085
Electric bratt pan	085
Fryers	086
Chips scuttle.....	087
Bain marie.....	087
Grills	088
Neutral elements	088
Stands and doors	089
Tables-supports.....	090

Gas appliances are prepared to be connected using
the indicated pressures:
LPG: 37 g/cm²
Natural Gas: 20 g/cm²

Open burner gas cookers



General characteristics









- Stamped stainless steel surface top.
- Double grill and nickel-plated burners.
- Dimensions of the double grill: 286 x 534 mm.
- Open burners with safety valve and thermocouples.
- Piezoelectric ignition of the burners.

- Controls with a protective support base and system to prevent water infiltration.
- Access to the components from the front.

OVEN

- Possibility of choosing between a stainless steel gas or electric static oven measuring 450 x 420 x 300 mm.

- Gas oven with 5.2 kW tubular burner with pilot flame and thermocouple.
- Electric oven with two 3 kW heating elements, one in the base and one at the top.
- Temperature controlled by thermostatic valve (120 – 350 °C).



	MODEL	GAS	CODE	BURNERS		OVEN	TOTAL POWER (KW)	DIMENSIONS (MM)	€
				3 KW	KW				
		C-G620	LPG	19080713	2	-	6,00	400x650x290	-
			NG	19080714					
		C-G640	LPG	19080715	4	-	12,00	600x650x290	-
			NG	19080716					
		C-G641	LPG	19080718	4	5,20	17,20	600x650x850	-
			NG	19080719					
		C-GE641	LPG	19080723	4	6,00	18,00	600x650x850	-
			NG	19080724					

Electric cookers



General characteristics

- Stamped stainless steel surface top.
- Cast iron electric plates with built-in heating elements controlled by 7-position switches.
- Controls with a protective support base and system to prevent water infiltration.
- Access to the components from the front. OVEN
- Stainless steel electric static oven measuring 450 x 420 x 300 mm.
- Heating element in the base (3 kW) and upper part (3 kW).
- Temperature controlled by thermostatic valve (50 – 350 °C).



MODEL	CODE	PLATES		OVEN 3+3 KW	TOTAL POWER (KW)	DIMENSIONS (MM)	€
		2,0 KW	1,5 KW				
 C-E620	19080720	2	-	-	4,00	400x650x290	-
 C-E640	19080721	3	1	-	7,50	600x650x290	-
 C-E641	19080722	3	1	1	13,50	600x650x850	-

Glass-ceramic cookers



General characteristics

- Stainless steel surface top.
- Two circular radiant heating element, one with a power of 1.5 kW and a circumference of 80 mm, and another of 2 kW and 210 mm.
- Power controlled by an 8-position switch.
- Controls with a protective support base and system to prevent water infiltration.

MODEL	CODE	PLATES		SURFACE (MM)	TOTAL POWER (KW)	DIMENSIONS (MM)	€
		2 KW	1,5 KW				
 C-V620	19080725	1	1	315x545	3,50	400x650x290	-
 C-V640	19080726	2	2	515x545	7,00	600x650x290	-

Fry-tops



General characteristics

- Models with flat, grooved or mixed stovetop (1/2 flat and 1/2 grooved).
- Gas: Stainless steel burner with pilot flame for ignition.
- One type of grill offers two separate heating areas.
- Electric models: Electric-heating models with embedded stainless steel heating elements and thermostat temperature control, from 50 to 310 °C.
- Versions featuring galvanised carbon steel valve or safety valve with thermocouple.
- Removable grease collection drawer.

	MODEL	GAS	CODE	TYPE	PLATE AREAS	(DM ²)	GAS POWER (kW)	DIMENSIONS (mm)	€
GAS FRY TOP									
Models with max-min valve									
	FT-G605 V L	LPG	19080739	L	1	20	4,70	400x650x290	-
		NG	19080750						
	FT-G605 V R	LPG	19080751	R	1	20	4,70	400x650x290	-
		NG	19080752						
	FT-G610 V L	LPG	19080758	L	2	30	7,00	600x650x290	-
		NG	19080759						
	FT-G610 V R	LPG	19080762	R	2	30	7,00	600x650x290	-
		NG	19080763						
	FT-G610 V L+R	LPG	19080760	L+R	2	30	7,00	600x650x290	-
		NG	19080761						
Models with chromium plate and thermostat (120 °C - 310 °C)									
	FT-G605 C L	LPG	19080736	C L	1	20	4,00	400x650x290	-
		NG	19080738						
	FT-G610 C L	LPG	19080753	C L	2	30	7,00	600x650x290	-
		NG	19080754						
	FT-G610 C L+R	LPG	19080755	C L+R	2	30	7,00	600x650x290	-
		NG	19080756						
ELECTRIC FRY-TOPS									
Control by thermostat (120 °C - 310 °C)									
	FT-E605 L	-	19080765	L	1	20	4,80	400x650x290	-
	FT-E605 R	-	19080766	R	1	20	4,80	400x650x290	-
	FT-E610 L	-	19080769	L	1	30	6,40	600x650x290	-
	FT-E610 R	-	19080771	R	1	30	6,40	600x650x290	-
	FT-E610 L+R	-	19080770	L+R	1	30	6,40	600x650x290	-
Control by thermostat and chromium hot-plate									
	FT-E605 C L	-	19080764	C L	1	20	4,80	400x650x290	-
	FT-E610 C L	-	19080767	C L	1	30	6,40	600x650x290	-
	FT-E610 C L+R	-	19080768	C L+R	1	30	6,40	600x650x290	-

TYPE OF PLATES: L: Smooth hot-plate. / R: Ribbed hot-plate. / L+R: 1/2 smooth hot-plate - 1/2 ribbed hot-plate. / C: 50 microns thickness chromium coated steel sheeting hot-plate.

Electric pasta cooker



General characteristics

- Well stamped in AISI-316 stainless steel integrated into the stainless steel surface top.
- 15-litre capacity well.
- Heating controlled by energy regulator with 8 positions.
- Lever tap to empty the well.
- Controls with a protective support base and a system that prevents water infiltration.
- Well dimensions: 250 x 350 x 130 mm.
- Equipment included: 4 baskets (120 x 160 x 120 mm).

MODEL	CODE	TANK		POWER (KW)	DIMENSIONS (MM)	€
		DIMENSIONS (MM)	(L)			
 CP-E605	19080710	250x350	15	6,00	400x650x290	-

Electric bratt pan



General characteristics

- Versatile machine that can be used as:
 - Roasting grill
 - Frying meal pan.
 - Pot to cook with liquid.
 - Bain-Marie.
- Made of stainless steel, with integrated well, GN-1/1 dimensions.
- Heating resistors hidden under the bottom of the well, controlled by a thermostat regulating the temperature between 50 °C - 250 °C.
- Lever tap to empty the well.
- Container to collect draining water from the well, located in the lower furniture, 200 mm deep.
- Also in Monophase version - 230 V - 1+N.









MODEL	CODE	TANK		ELECTRIC POWER (KW)	DIMENSIONS (MM)	€
		SIZE	(L)			
 CMF6-05	19080711	GN-1/1	15	3,20	400x650x850	-

Fryers



General characteristics

- Well stamped in stainless steel integrated into the stainless steel surface top.
- Thermostatic temperature control between 60 and 200 °C.
- Safety thermostat.
- Gas models: automatic ignition of burners using electromagnetic valve with pilot and thermocouple.
- Electric models: swivelling heating element making it easier to clean inside the well.
- Lever tap to empty the well located in the control panel.
- Basket dimensions: 200 x 250 x 100 mm.
- Built-in well cover.
- Controls with a protective support base and system to prevent water infiltration.

	MODEL	GAS	CODE	TANKS			POWER (kW)	DIMENSIONS (mm)	€	
				QUANTITY	VOLUMEN (L)	BASKETS				
GAS FRYERS										
		F-G6108	LPG	19080729	1	8	1	7	400x650x290	-
			NG	19080730						
		F-G6208	LPG	19080731	2	2x8	2	14	600x650x290	-
			NG	19080732						
ELECTRIC FRYERS										
		F-E6108	-	19080734	1	8	1	6	400x650x290	-
		F-E6208	-	19080735	2	2x8	2	12	600x650x290	-

Chips scuttle



General characteristics

- Made of stainless steel with a removable GN-1/1-size well.
- Removable filter.
- Upper 1 kW ceramic heating element.
- On/off switch.

MODEL	CODE	TANK		POWER (KW)			DIMENSIONS (MM)	€
		CONTAINER	(DM ³)	UPPER	LOWER	TOTAL		
 MF-E605	19080772	GN-1/1	20	1,00	-	1,00	400x650x290	-

Bain marie



General characteristics

- Integrated stainless-steel stamped well in GN-1/1 size with a depth of 150 mm.
- Silicone heating elements hidden underneath the well.
- Thermostatic temperature control between 30 and 90 °C.
- Safety thermostat.
- Lever tap to empty the well.
- Containers not included.
- Controls with a protective support base and system to prevent water infiltration.

MODEL	CODE	TANK		ELECTRIC POWER (KW)	DIMENSIONS (MM)	€
		SIZE	(L)			
 BM-E605	19080577	GN-1/1	15	1,60	400x650x290	-

Gas charcoal grills



General characteristics

- Tabletop appliances.
- Stainless-steel grill with adjustable height.
- Grill dimensions: 400 x 500 mm
- Heating the volcanic rocks through stainless-steel tubular burners.
- Burner ignition through electronic spark igniter
- Appliances fitted with stainless-steel rear plate to prevent splashes.
- Removable grease collection drawer.
- Controls with a protective support base and a system that prevents water infiltration.

MODEL	GAS	CODE	GRIDS			GAS POWER		DIMENSIONS (MM)	€
			TYPE	QUANTITY	(DM ²)	(KCAL/H)	(KW)		
B-G605 I	LPG	19080578	Stainless Steel	1	20	6.000	6,98	400x650x440	-
	NG	19080579							



Neutral elements



General characteristics

- Removable stainless steel surface top.





MODEL	CODE	DIMENSIONS (MM)	€
EN-605	19080727	400x650x290	-
EN-610	19080728	600x650x290	-



Stands and doors

- Manufactured with a stainless-steel solid structure.
- Can be quickly connected to serve as a support for surface-top elements from the 600 range.
- Can be used as an open storage element.
- Designed for the attachment of doors to turn them into closed cupboards.







MODEL	CODE	DOORS OPTIONAL (NOT INCLUDED)	DIMENSIONS (MM)	€	
STANDS					
 	MB-605	19004904	Kit Door 400	400x650x560	-
 	MB-610	19004987	Kit Door 600	600x650x560	-
DOORS					
	KIT DOOR 600	19004430	Complete door (2 pieces) for MB6-10 stand	2 (300x560)	-
	KIT DOOR 400	19004581	Single right or left door for MB6-05 stand	400x560	-
	600 RANGE JOINT	19004478	Module joint 600 range		-

Tables - supports



General characteristics

- Made of stainless steel.
- Low rack.





MODEL	CODE	DIMENSIONS (MM)	€
 MNB-120	19006348	1.200x700x600	-
 MNB-140	19006462	1.400x700x600	-
 MNB-160	19006564	1.600x700x600	-
 MNB-180	19006782	1.800x700x600	-
 MNB-200	19007021	2.000x700x600	-

Tables - supports with doors



General characteristics

- Made of stainless steel.
- Sliding doors.

MODEL	CODE	DIMENSIONS (MM)	€
 ANB-120	19006349	1.200x700x600	-
 ANB-140	19006463	1.400x700x 600	-
 ANB-160	19006565	1.600x700x600	-
 ANB-180	19006783	1.800x700x600	-
 ANB-200	19007022	2.000x700x600	-



Large capacity
cooking
equipment.



Find out more!



Access the website



Large capacity cooking equipment

Boiling pans

Fixed cylindrical boiling pans.....	093
Fixed cylindrical boiling pans with mixer	095
Tilting cylindrical boiling pans	097
Fixed rectangular boiling pans	099
Fixed Gastronorm rectangular boiling pans	101
Automatic tilting rectangular boiling pans with mixer and PLC monitor	103

Tilting bratt pans

Motorised tilting bratt pans.....	105
Automatic tilting bratt pans on frame....	107

Automatic cookers	109
-------------------------	-----

Fixed cylindrical boiling pans



General Characteristics

- Boiling pan with cylindrical structure and recipient, suitable for placement in transit areas with reduced dimensions where appliances with sharp edges and surfaces may cause ergonomic and movement problems, allowing it to be used comfortably from different angles.
- Well with AISI-316 stainless steel bottom with a thickness of between 20/10 and 40/10, suitable for products that are particularly acidic.
- AISI-304 stainless steel walls with a thickness of between 20/10 and 40/10. Double wall in indirect versions.
- AISI-304 stainless steel cover with a thickness of 15/10, balance springs and an athermic handle.
- Supporting structure in AISI-304 stainless steel.
- Satin AISI-304 exterior coating.
- Adjustable stainless-steel feet.
- Heat insulation guaranteed by high-density ceramic fibre plates.
- Tank drainage hole with a removable filter.
- Front drainage tap with an insulated athermic handle.
- Gauge for controlling pressure inside the double wall.
- Manual valve for emptying air in order to depressurise the chamber during heating.
- Water is added to the well through a tap with a moveable outlet.
- Heating:
 - . Gas:
 - High-performance stainless-steel tubular burners.
 - Manual piezoelectric ignition and pilot flame.
 - Smoke extraction grille.
 - Tap with safety valve and thermocouples (direct version).
 - . Indirect electric:
 - Heated by heating elements immersed in Incoloy alloy with adjustable power thanks to an energy variator.
- Safety thermostat which ensures that the machine does not operate in the event of overheating or insufficient water.
- Water control in the double wall with maximum/minimum taps and an automatic water load option.
- Standard operating voltage of 400V-3N-50Hz
 - . Indirect steam:
 - Heated by steam (from the user's connection) through a valve that allows steam to be added gradually into the liner.
 - Indirect heating equipment: pressure control in the double wall through a safety valve set to 0.5 bar, a manual depression valve and a gauge.
- The pressure or autoclave versions allow the cooking cycles to speed up through the day. They are fitted with a silicone rubber airtight joint and clamps to hermetically close it and a safety valve set to 0.05 bar.

MODEL	CODE	POWER (KW)	CAPACITY (L)	DIMENSIONS (mm)	€
CYLINDRICAL GAS BOILING PANS					
Directly heated gas					
MCG-300	19003043	39	300	1290x1391x950	-
MCG-500	19001445	55	500	1390x1479x1020	-
Directly pressure heated gas					
MCG-300 A	19003041	39	300	1290x1391x950	-
MCG-500 A	19001446	55	500	1390x1479x1020	-
Indirectly heated gas					
MCIG-200	19003078	39	200	1090x1195x900	-
MCIG-300	19001448	48	300	1290x1391x950	-
MCIG-500	19003079	55	500	1390x1479x1020	-
Indirectly pressure heated gas					
MCIG-200 A	19001447	39	200	1090x1195x900	-
MCIG-300 A	19001449	48	300	1290x1391x950	-
MCIG-500 A	19001450	55	500	1390x1479x1020	-
ELECTRIC CYLINDRICAL BOILING PANS					
Indirectly heated electric					
MCIE-200	19003076	24	200	1060x1000x900	-
MCIE-300	19001443	36	300	1260x1200x950	-
MCIE-500	19003077	48	500	1360x1300x1000	-
Indirectly pressure heated electric					
MCIE-200 A	19001442	24	200	1060x1000x900	-
MCIE-300 A	19003040	36	300	1260x1200x950	-
MCIE-500 A	19001444	48	500	1360x1300x1000	-
STEAM CYLINDRICAL BOILING PANS					
Indirectly heated steam					
MCIV-200	19003080	-	200	1095x1000x900	-
MCIV-300	19001453	-	300	1295x1200x950	-
MCIV-500	19003081	-	500	1395x1300x1000	-
Indirectly pressure heated steam					
MCIV-200 A	19001452	-	200	1095x1000x900	-
MCIV-300 A	19003051	-	300	1295x1200x950	-
MCIV-500 A	19001454	-	500	1395x1300x1000	-

Accessories

MODEL	CODE	DESCRIPTION	€
CM-2200	19084524	Kit 2 1/2 baskets for 200-litre boiling pan	-
CM-2300	19084525	Kit 2 1/2 baskets for 300-litre boiling pan	-
CM-4300	19084526	Kit 4 1/4 baskets for 300-litre boiling pan	-
CM-4500	19084527	Kit 4 1/4 baskets for 500-litre boiling pan	-
GF-M	19084528	Drainage tap with 2" AISI-316 clamp connection	-
VM-M	19084529	2.5" AISI-304 butterfly valve ISO DN50	-
TD-M	19084539	Flexible tube with shower	-
DA-M	19084530	Device for automatic drainage of air from double wall	-
CENA-M	19084531	Electronic control of water load in double wall	-
CECA-M	19084532	Electronic control of water load in the well with display and volumetric probe	-

Fixed cylindrical boiling pans with mixer



General Characteristics

- Well with AISI-316 stainless steel bottom with a thickness of between 20/10 and 40/10, suitable for products that are particularly acidic.
- AISI-304 stainless steel cooking well walls with thickness of between 20/10 and 25/10.
- Tank drainage hole with a removable filter.
- 2" front drainage tap with insulated athermic handle.
- Double wall with AISI-304 stainless steel bottom and walls.
- AISI-304 stainless steel cover with a thickness of 15/10, fitted with a chromed steel zip with preloading springs and an athermic handle.
- Gauge for controlling pressure inside the double wall.
- Manual air escape valve for depressurising the air produced in the double wall during the heating process.
- 2 versions:
 - . Normal version: safety valve with a spring set to 0.5 bar.
 - . Autoclave version: silicone rubber joint restraint, clamps to hermetically seal the cover and a safety valve set to 0.05 bar.
- Stainless steel supporting structure with a thickness of 30/10 fitted on steel feet with an adjustable height.
- AISI-304 satin stainless steel external walls with a thickness of 10/10.
- AISI-304 stainless steel satin shelf with a thickness of 15/10.
- Removable inner coating to enable easy inspection of internal parts.
- Heat insulation guaranteed by high-density ceramic fibre plates.
- Mixing system:
 - . AISI-316 stainless steel mixer with an adjustable rotation speed of between 7 and 28 g/m with a force of up to 386 N-m
 - . Possibility to reverse the operating direction with the electronic switch.
 - . Removable mixer to ease cleaning and product extraction.
 - . Mixer fitted with stainless steel radial arms and Teflon ceramic blades.
- Heating:
 - . Indirect electric with double wall:
 - Heated by heating elements immersed in Incoloy alloy with adjustable power thanks to an energy variator.
- Thermoregulation and electronic time delay of the temperature and process time.
- Heating elements fitted with a safety thermostat which ensures that the machine does not operate in the event of overheating or insufficient water.
- Water control in the double wall with maximum/minimum taps and an automatic water load option with probes.
- Pressure control of the double wall through a pressure switch and a safety valve set to 0.5 bar, a depression valve and a gauge.
- Standard operating voltage of 400V-3N-50Hz.
- . Indirect steam with double wall:
 - Heated by steam (from the user's connection) with a counter-pressure valve that allows steam to be added gradually to the double wall.
 - Pressure control in the double wall through the safety valve set to 0.5 bar, depression valve and gauge.
 - Standard operating voltage of 400V-3N-50Hz.

MODEL	CODE	POWER (KW)	CAPACITY (L)	DIMENSIONS (mm)	€
ELECTRIC CYLINDRICAL BOILING PANS WITH MIXER					
Indirectly heated electric					
MCIE-200 M	19084225	24.37	200	1120x1000x1000	-
MCIE-300 M	19084227	36.37	300	1320x1200x950	-
MCIE-500 M	19084231	48.37	500	1420x1300x1050	-
Indirectly pressure heated electric					
MCIE-200 A M	19084226	24.37	200	1120x1000x1000	-
MCIE-300 A M	19084229	36.37	300	1320x1200x950	-
MCIE-500 A M	19084232	48.37	500	1420x1300x1050	-
STEAM CYLINDRICAL BOILING PANS WITH MIXER					
Indirectly heated steam					
MCIV-200 M	19084233	0.37	200	1120x1000x1000	-
MCIV-300 M	19084235	0.37	300	1320x1200x950	-
MCIV-500 M	19084237	0.37	500	1420x1300x1050	-
Indirectly pressure heated steam					
MCIV-200 A M	19084234	0.37	200	1120x1000x1000	-
MCIV-300 A M	19084236	0.37	300	1320x1200x950	-
MCIV-500 A M	19084238	0.37	500	1420x1300x1050	-

Accessories

MODEL	CODE	DESCRIPTION	€
GF-M	19084528	Drainage tap with 2" AISI-316 clamp connection	-
VM-M	19084529	2.5" AISI-304 butterfly valve ISO DN50	-
TD-M	19084539	Flexible tube with shower	-
DA-M	19084530	Device for automatic drainage of air from double wall	-
CENA-M	19084531	Electronic control of water load in double wall	-
CECA-M	19084532	Electronic control of water load in the well with display and volumetric probe	-

Tilting cylindrical boiling pans



General Characteristics

- Automatic tilting boiling pan with lateral loading columns. The tilting of the well eases the transfer of solid foods. This is the quickest and easiest way of cooking high quantities.
 - Cooking well with an AISI-316 stainless steel bottom with a thickness of between 20/10 and 40/10, and an AISI-304 stainless steel double wall with thicknesses of between 20/10 and 25/10.
 - AISI-304 stainless steel cover with a thickness of 15/10, balance springs; an athermic handle and an insulated cover available upon request.
 - Gauge for controlling pressure inside the double wall.
 - Manual air escape valve for depressurising the air produced in the double wall during the heating process.
 - Adjustable chromed bronze mixer with hot and cold water.
 - Weight safety valve set to 0.5 bar.
 - Stainless steel supporting structure with a thickness of 30/10 fitted on a frame.
 - Fine satin AISI-304 exterior. Thermal insulation guaranteed by high-density ceramic fibre panels.
 - Automatic tilting system via a hydraulic cylinder.
 - Automatic shut-off system when inclined.
 - Heating:
 - GAS:
 - High-performance stainless-steel tubular burners.
 - Manual piezoelectric ignition and pilot flame.
 - Smoke extraction grille.
 - Tap with safety valve and thermocouples (direct version).
 - Indirect electric:
 - Heated by heating elements immersed in Incoloy alloy with adjustable power thanks to an energy variator.
 - Safety thermostat which ensures that the machine does not operate in the event of overheating or insufficient water.
 - Water control in the double wall with maximum/minimum taps and an automatic water load option.
 - Standard operating voltage of 400V-3N-50Hz
- INDIRECT STEAM:**
- Heated by steam (from the user's connection) through a valve that allows steam to be added gradually into the liner.
 - Indirectly heated equipment: pressure control in the double wall through the safety valve set to 0.5 bar, manual depression valve and gauge.

MODEL	CODE	POWER (KW)	CAPACITY (L)	DIMENSIONS (mm)	€
GAS TILTING CYLINDRICAL BOILING PANS					
Directly heated gas					
MCBG-100	19001283	26.4	100	1600x970x1050	-
MCBG-150	19001227	26.4	150	1600x970x1050	-
MCBG-200	19001284	39.4	200	1750x1135x1050	-
MCBG-300	19001228	39.4	300	1960x1325x1300	-
MCBG-500	19001285	55.4	500	2050x1475x1300	-
Indirectly heated gas					
MCBIG-100	19001229	26.4	100	1600x970x1050	-
MCBIG-150	19001286	26.4	150	1600x970x1050	-
MCBIG-200	19001230	39.4	200	1750x1135x1050	-
MCBIG-300	19001287	48.4	300	1960x1325x1300	-
MCBIG-500	19001231	55.4	500	2050x1475x1300	-
ELECTRIC TILTING CYLINDRICAL BOILING PANS					
Indirectly heated steam					
MCBIE-100	19001278	12.4	100	1600x885x1050	-
MCBIE-150	19003052	16.4	150	1600x885x1050	-
MCBIE-200	19001280	24.4	200	1750x1035x1050	-
MCBIE-300	19003053	36.4	300	1950x1230x1300	-
MCBIE-500	19001282	48.4	500	2050x1370x1300	-
STEAM TILTING CYLINDRICAL BOILING PANS					
Indirectly heated steam					
MCBIV-100	19003072	0.4	100	1600x885x1050	-
MCBIV-150	19001289	0.4	150	1600x885x1050	-
MCBIV-200	19003073	0.4	200	1750x1035x1050	-
MCBIV-300	19001291	0.4	300	1950x1230x1300	-
MCBIV-500	19003074	0.4	500	2050x1370x1300	-

Accessories

MODEL	CODE	DESCRIPTION	€
GF-M	19084528	Drainage tap with 2" AISI-316 clamp connection	-
VM-M	19084529	2.5" AISI-304 butterfly valve ISO DN50	-
TD-M	19084539	Flexible tube with shower	-
DA-M	19084530	Device for automatic drainage of air from double wall	-
CENA-M	19084531	Electronic control of water load in double wall	-
CECA-M	19084532	Electronic control of water load in the well with display and volumetric probe	-
FBM-150	19084533	Drainage filter nozzle for 100-150-litre boiling pan	-
FBM-200	19084534	Drainage filter nozzle for 200-litre boiling pan	-
FBM-300	19084535	Drainage filter nozzle for 300-litre boiling pan	-
FBM-500	19084536	Drainage filter nozzle for 500-litre boiling pan	-

Fixed rectangular boiling pans



General Characteristics

- Rectangular boiling pan with a cylindrical well. Can be assembled on its own or with other machines. Thanks to its rigidity and functionality, it is suitable for prolonged and continuous use.
 - Cooking well with an AISI-316 stainless steel bottom with a thickness of between 20/10 and 40/10, and AISI-304 stainless steel walls with thicknesses of between 20/10 and 25/10.
 - Tank drainage hole with a removable filter.
 - Front drainage tap with insulated athermic handle.
 - AISI-304 stainless steel cover with a thickness of 15/10, fitted with a chromed steel zip with preloading springs and an athermic handle.
 - Gauge for controlling pressure inside the double wall.
 - Manual air escape valve for depressurising the air produced in the double wall during the heating process.
 - 2 versions:
 - . Normal version: spring and weight safety valve (depending on the capacity of the machine) set to 0.5 bar.
 - . Autoclave version: silicone rubber joint restraint, clamps to hermetically seal the cover. Safety valve set to 0.05 bar.
 - Stainless steel supporting structure with a thickness of 30/10 fitted on steel feet with an adjustable height.
 - AISI-304 satin stainless steel external walls with a thickness of 10/10.
 - AISI-304 stainless steel satin shelf with a thickness of 15/10.
 - Heating:
 - GAS:
 - High-performance stainless-steel tubular burners.
 - Manual piezoelectric ignition and pilot flame.
 - Smoke extraction grille.
 - Tap with safety valve and thermocouples (direct version).
 - . Indirect electric:
 - Heated by heating elements immersed in Incoloy alloy with adjustable power thanks to an energy variator.
 - Safety thermostat which ensures that the machine does not operate in the event of overheating or insufficient water.
 - Water control in the double wall with maximum/minimum taps and an automatic water load option.
 - Standard operating voltage of 400V-3N-50Hz
- INDIRECT STEAM:**
- Heated by steam (from the user's connection) through a valve that allows steam to be added gradually into the liner.
 - Indirect heating equipment: pressure control in the double wall through a safety valve set to 0.5 bar, a manual depression valve and a gauge.

MODEL	CODE	POWER (KW)	CAPACITY (L)	DIMENSIONS (mm)	€
GAS RECTANGULAR BOILING PANS					
Directly heated gas					
MRG-300	19001273	39	300	1200x1270x900	-
MRG-500	19001418	55	500	1300x1400x1000	-
Directly pressure heated gas					
MRG-300 A	19003031	39	300	1200x1270x900	-
MRG-500 A	19001419	55	500	1300x1400x1000	-
Indirectly heated gas					
MRIG-200	19003091	39	200	1000x1150x850	-
MRIG-300	19001421	48	300	1200x1270x900	-
MRIG-500	19001272	55	500	1300x1400x1000	-
Indirectly pressure heated gas					
MRIG-200 A	19001420	39	200	1000x1150x850	-
MRIG-300 A	19003045	48	300	1200x1270x900	-
MRIG-500 A	19001422	55	500	1300x1400x1000	-
ELECTRIC RECTANGULAR BOILING PANS					
Indirectly heated electric					
MRIE-200	19001414	24	200	1000x1150x850	-
MRIE-300	19003082	36	300	1200x1270x900	-
MRIE-500	19001416	48	500	1300x1400x1000	-
Indirectly pressure heated electric					
MRIE-200 A	19001274	24	200	1000x1150x850	-
MRIE-300 A	19001415	36	300	1200x1270x900	-
MRIE-500 A	19001275	48	500	1300x1400x1000	-
STEAM RECTANGULAR BOILING PANS					
Indirectly heated steam					
MRIV-200	19001424	-	200	1000x1150x850	-
MRIV-300	19003087	-	300	1200x1270x900	-
MRIV-500	19001426	-	500	1300x1400x1000	-
Indirectly pressure heated steam					
MRIV-200 A	19003089	-	200	1000x1150x850	-
MRIV-300 A	19001425	-	300	1200x1270x900	-
MRIV-500 A	19003090	-	500	1300x1400x1000	-

Accessories

MODEL	CODE	DESCRIPTION	€
CM-2200	19084524	Kit 2 1/2 baskets for 200-litre boiling pan	-
CM-2300	19084525	Kit 2 1/2 baskets for 300-litre boiling pan	-
CM-4300	19084526	Kit 4 1/4 baskets for 300-litre boiling pan	-
CM-4500	19084527	Kit 4 1/4 baskets for 500-litre boiling pan	-
GF-M	19084528	Drainage tap with 2" AISI-316 clamp connection	-
VM-M	19084529	2.5" AISI-304 butterfly valve ISO DN50	-
TD-M	19084539	Flexible tube with shower	-
DA-M	19084530	Device for automatic drainage of air from double wall	-
CENA-M	19084531	Electronic control of water load in double wall	-
CECA-M	19084532	Electronic control of water load in the well with display and volumetric probe	-

Fixed Gastronorm rectangular boiling pans



General Characteristics

- Rectangular boiling pan with a Gastronorm rectangular well. Can be assembled on its own or with other machines. Thanks to its rigidity and functionality, it is suitable for prolonged and continuous use.
 - Cooking well with an AISI-316 stainless steel bottom with a thickness of 25/10 and AISI-304 stainless steel walls with thicknesses of between 20/10 and 25/10.
 - Front drainage tap with an insulated athermic handle.
 - AISI-304 stainless steel cover with a thickness of 15/10, balance springs; an athermic handle and an insulated cover available upon request.
 - Gauge for controlling pressure inside the double wall.
 - Manual air escape valve for depressurising the air produced in the double wall during the heating process.
 - Adjustable chromed bronze mixer with hot and cold water.
 - Weight safety valve set to 0.5 bar.
 - With a stainless steel supporting structure.
 - Equipped with stainless steel support feet with an adjustable height and a manually emptied liner filter.
 - AISI-304 exterior coating. Fine satin. Heat insulation guaranteed by high-density ceramic fibre plates.
 - Heating:
 - GAS:
 - High-performance stainless-steel tubular burners.
 - Manual piezoelectric ignition and pilot flame.
 - Smoke extraction grille.
 - Tap with safety valve and thermocouples (direct version).
 - Indirect electric:
 - Heated by heating elements immersed in Incoloy alloy with adjustable power thanks to an energy variator.
 - Safety thermostat which ensures that the machine does not operate in the event of overheating or insufficient water.
 - Water control in the double wall with maximum/minimum taps and an automatic water load option.
 - Standard operating voltage of 400V-3N-50Hz
- INDIRECT STEAM:**
- Heated by steam (from the user's connection) through a valve that allows steam to be added gradually into the liner.
 - Indirect heating equipment: pressure control in the double wall through a safety valve set to 0.5 bar, a manual depression valve and a gauge.

MODEL	CODE	POWER (KW)	CAPACITY (L)	DIMENSIONS (mm)	€
GAS GASTRONORM RECTANGULAR BOILING PANS					
Directly heated gas					
MGNG-280	19084264	35	280	1400x900x850	-
Indirectly heated gas					
MGNIG-180	19001394	29	180	1000x900x850	-
MGNIG-280	19003083	35	280	1400x900x850	-
MGNIG-400	19003084	45	400	2000x900x850	-
ELECTRIC GASTRONORM RECTANGULAR BOILING PANS					
Indirectly heated electric					
MGNIE-180	19003046	18	180	1000x900x850	-
MGNIE-280	19001312	24	280	1400x900x850	-
MGNIE-400	19001393	36	400	2000x900x850	-
STEAM GASTRONORM RECTANGULAR BOILING PANS					
Indirectly heated steam					
MGNIV-180	19001396	0.05	180	1000x900x850	-
MGNIV-280	19003049	0.05	280	1400x900x850	-
MGNIV-400	19003050	0.05	400	2000x900x850	-

Accessories

MODEL	CODE	DESCRIPTION	€
GF-M	19084528	Drainage tap with 2" AISI-316 clamp connection	-
VM-M	19084529	2.5" AISI-304 butterfly valve ISO DN50	-
TD-M	19084539	Flexible tube with shower	-
DA-M	19084530	Device for automatic drainage of air from double wall	-
CENA-M	19084531	Electronic control of water load in double wall	-
CECA-M	19084532	Electronic control of water load in the well with display and volumetric probe	-

Automatic tilting rectangular boiling pans with mixer and PLC monitor



General Characteristics

- AISI-316 lucid stainless steel recipient bottom, suitable for products that are particularly acidic, with a thickness of between 20/10 and 40/10.
- AISI-304 stainless steel cooking well walls with thickness of between 20/10 and 25/10.
- Double wall with AISI-304 stainless steel bottom and walls.
- Tank drainage hole with removable filter (optional).
- Front drainage tap with insulated athermic handle (optional).
- AISI-304 stainless steel cover with a thickness of 15/10, fitted with a steel zip with preloading springs and an athermic handle.
- Gauge for controlling pressure inside the double wall.
- Manual air escape valve for depressurising the air produced in the double wall during the heating process.
- Adjustable chromed bronze mixer with hot and cold water.
- Weight safety valve set to 0.5 bar.
- Stainless steel supporting structure with a thickness of 40/10 fitted on steel feet with an adjustable height and a clamp for attaching it to the floor.
- AISI-304 satin stainless steel external walls with a thickness of 10/10.
- AISI-304 stainless steel satin shelf with a thickness of 15/10.
- AISI-316 stainless steel removable mixer with an adjustable rotation speed of between 7 and 28 g/m with a force of up to 386 N·m.
- Possibility to reverse the operating direction with the electronic switch.
- Stainless steel radial arms and Teflon ceramic scraping blades.
- PLC monitor:
 - . Allows up to 100 modifiable cooking programmes that can be managed and personalised, even during cooking.
 - . Fitted with a touch screen and manual controls for operation, water load, inclination and movement of the mixer.
 - . Fitted with acoustic warning message indicators (yellow) for correct functioning or alarms (red) in case of incorrect functioning.
 - . All of the settings are customisable and can be viewed and modified even during cooking (name, wait, water load, times, temperatures, probes, mixing speed, time, etc.).
- Heating:
 - . Indirectly heated gas:
 - Ignited with a manual piezoelectric and pilot flame.
 - Heated by tubular boilers and high-performance AISI-304 stainless steel.
 - Smoke extraction grille.
 - Set of nozzles for different types of gas.
 - Water level control in the double wall with maximum/minimum taps and an automatic water load option.
 - Pressure control of the double wall through the safety valve set to 0.5 bar, depression valve and gauge.
 - . Indirectly heated electric:
 - Heated by a set of electric heating elements.
 - Safety thermostat which ensures that the machine does not operate in the event of overheating or insufficient water.
 - Temperature control (50 - 120 °C).
 - . Indirectly heated steam:
 - Heated by steam (from the user's connection) with a counter-pressure valve that allows steam to be added gradually to the double wall.
 - Pressure control in the double wall through the safety valve set to 0.5 bar, depression valve and gauge.

MODEL	CODE	POWER (KW)	CAPACITY (L)	DIMENSIONS (mm)	€
Indirectly heated gas					
MRBIG-200 M	19084239	35.75	200	1674x1450x1140	-
MRBIG-300 M	19084240	35.75	300	1874x1650x1140	-
MRBIG-500 M	19084241	42.75	500	1976x1835x1140	-
Indirectly heated electric					
MRBIE-200 M	19084242	24.75	200	1674x1450x1140	-
MRBIE-300 M	19084243	36.75	300	1874x1650x1140	-
MRBIE-500 M	19084244	48.75	500	1976x1835x1140	-
Indirectly heated steam					
MRBIV-200 M	19084245	0.75	200	1674x1450x1140	-
MRBIV-300 M	19084246	0.75	300	1874x1650x1140	-
MRBIV-500 M	19084247	0.75	500	1976x1835x1140	-

Accessories

MODEL	CODE	DESCRIPTION	€
GF-M	19084528	Drainage tap with 2" AISI-316 clamp connection	-
VM-M	19084529	2.5" AISI-304 butterfly valve ISO DN50	-
TD-M	19084539	Flexible tube with shower	-
DA-M	19084530	Device for automatic drainage of air from double wall	-
CENA-M	19084531	Electronic control of water load in double wall	-
CECA-M	19084532	Electronic control of water load in the well with display and volumetric probe	-
FBM-150	19084533	Drainage filter nozzle for 100-150-litre boiling pan	-
FBM-200	19084534	Drainage filter nozzle for 200-litre boiling pan	-
FBM-300	19084535	Drainage filter nozzle for 300-litre boiling pan	-
FBM-500	19084536	Drainage filter nozzle for 500-litre boiling pan	-

Motorised tilting bratt pans



General features

- Cooking chamber walls made from AISI 304 stainless steel.
- Bottom made from 10 mm thick AISI 304 stainless steel Option: 12 mm thick bottom made from composite (9 mm iron + 3 mm steel).
- Cooking chamber with non-stick finish and ceramic microspheres.
- Water can be added into the chamber using a single hole tap.
- 10/10 thick AISI 304 stainless steel lid, with chrome plated rack and preloaded spring and stainless steel handle.
- 20/10 thick stainless steel supporting structure, mounted on adjustable steel feet for levelling.
- 10/10 thick satin-finished AISI 304 stainless steel external walls.
- 20/10 thick satin-finished AISI 304 stainless steel shelf.
- Automatic motorised tilting - Includes a manual tilting system in the event of a fault.
- Automatic shutdown in the event of system failure.
- Heating:
 - DIRECT GAS:
 - Manual Piezoelectric ignition and pilot flame.
 - Heating via tube and high performance AISI 304 stainless steel burners.
 - Smoke extraction grille.
 - Set of nozzles for different types of gas.
 - Safety thermostat
 - Tap with safety valve and thermocouple.
- Temperature regulated between 100 °C and 300 °C Direct electric:
 - Heating via a set of electric elements.
 - Safety thermostat for elements that prevents overheating.
 - Temperature control (50 °C - 260 °C).
 - Standard supply voltage 400 V 3N 50/60 Hz.

MODEL	CODE	POWER (KW)	CAPACITY (L)	DIMENSIONS (mm)	€
Direct gas heating					
SBG-150 M	19072688	33,01	150	1200x900x850	-
SBG-200 M	19079430	44,01	200	1600X900X850	-
Direct electric heating					
SBE-150 M	19072695	15,1	150	1200x900x850	-
SBE-200 M	19085076	20,1	200	1600X900X850	-

Options

CÓDIGO	DESCRIPTION	€
*	12 mm composite bottom (9mm iron + 3 mm steel) for 150 L pans.	-
*	12 mm composite bottom (9mm iron + 3 mm steel) for 200 L pans.	-

(*) Check version.

Automatic tilting bratt pans on frame



General features

- Base and walls of cooking chamber made from AISI 304 stainless steel:
- SBGA and SBEA models: bottom made from 10 mm thick AISI 316 stainless steel
Option: 12 mm thick composite (9 mm iron + 3 mm steel).
- SBGAX and SBEAX models: bottom made from 15 mm thick AISI 316 stainless steel
Option: 15 mm thick composite (12mm iron + 3mm steel).
- Cooking chamber with non-stick finish and ceramic microspheres.
- Water can be added into the chamber via a single tap point.
- 10/10 thick AISI 304 stainless steel lid, with chrome plated rack and preloaded spring and stainless steel handle.
- Supporting structure made from 40/10 thick stainless steel, mounted on adjustable steel feet for levelling.
- 10/10 thick satin-finished AISI 304 stainless steel external walls.
- 15/10 thick satin-finished AISI 304 stainless steel shelf.
- Automatic tilting with hydraulic drive on the front axle
- Automatic shutdown in the event of system failure.
- Heating system:
 - DIRECT GAS:
 - Manual or electric Piezo electric ignition and pilot flame (SBGAX and SBEAX versions).
 - Heating via tube and high performance AISI 304 stainless steel burners.
 - Smoke extraction grille.
 - Set of nozzles for different types of gas.
 - Safety thermostat.
 - DIRECT ELECTRIC:
 - Heating via a set of electric elements.
 - Safety thermostat for elements that prevents overheating or inadequate heat levels.
 - Temperature control (100°C - 250°C).
 - Standard supply voltage 400 V 3N 50/60 Hz.
- Tap with safety valve and thermocouple.
- Temperature regulated between 100 °C and 250°C

MODEL	CODE	POWER (KW)	CAPACITY (L)	DIMENSIONS (mm)	€
Direct gas heating					
SBGA-130	19085077	33,04	130	1600x905x930	-
SBGA-150	19085078	33,04	150	1600x905x930	-
SBGA-165	19085079	44,04	165	2000x905x930	-
SBGA-210	19085080	44,04	210	2000x905x930	-
SBGAX-300	19085082	33,75	300	1420x1840x1350	-
SBGAX-400	19085083	33,75	400	1420x1840x1350	-
Direct electric heating					
SBEA-130	19085084	15,4	130	1600x905x930	-
SBEA-150	19085085	15,4	150	1600x905x930	-
SBEA-165	19085086	20,4	165	2000x905x930	-
SBEA-210	19085087	20,4	210	2000x905x930	-
SBEAX-300	19085088	28,75	300	1420x1840x1350	-
SBEAX-400	19085089	28,75	400	1420x1840x1350	-

Accessories

MODEL	CODE	DESCRIPTION	€
TD-M	19084539	Flexible hose with shower	-

Options

CODE	DESCRIPTION	€
*	12 mm composite bottom (9mm iron + 3 mm steel) for 130 and 150 L pans.	-
*	12 mm composite bottom (9mm iron + 3 mm steel) for 165, 200 and 210 L pans.	-
*	15 mm composite bottom (12mm iron + 3mm steel) for 300 and 400 L pans.	-

(*) Check version.

Automatic cookers

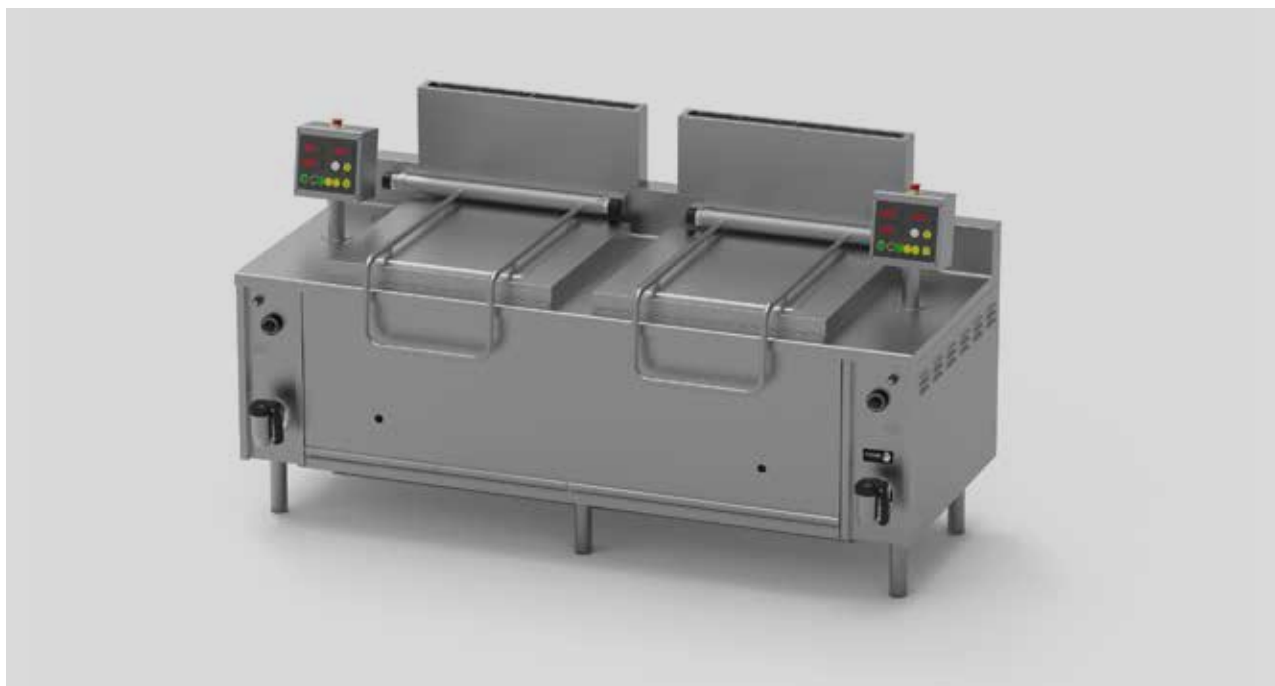

General Characteristics

- Well fully made from AISI-316 satin stainless steel.
- AISI-316 satin stainless steel baskets.
- Overflow and tap for output and drainage.
- AISI-304 stainless steel cover with a thickness of 15/10, fitted with a steel zip with preloading springs and an athermic handle.
- Gauge for controlling pressure inside the double wall.
- Manual air escape valve for depressurising the air produced in the double wall during the heating process.
- Adjustable chromed bronze mixer with hot and cold water.
- Weight safety valve set to 0.5 bar.
- Stainless steel supporting structure with a thickness of 20/10 fitted on stainless steel feet that can be adjusted between 150 mm and 180 mm.
- AISI-304 satin stainless steel external walls with a thickness of 10/10.
- AISI-304 stainless steel satin shelf with a thickness of 15/10.
- Fitted with digital controls with 3 displays showing 4 numbers, enabling the temperature to be adjusted between 20 °C and 110 °C.
- Possibility to change amount of time the basket is submerged, with a minimum interval of 1 second.
- Acoustic illuminated indicator to inform of the end of the cooking cycle.
- Cooking shut-off with time delayed water reintegration at the end of cooking.
- Automatic raising of the basket at the end of cooking.
- Possibility to manage the position of the basket: first drip and then unload or direct front unload.
- Heating:
 - . Directly heated gas:
 - Ignited with a manual piezoelectric and pilot flame.
 - Heated by tubular boilers and high-performance AISI-304 stainless steel.
 - . Indirectly heated steam with double wall:
 - Heated by a set of electric heating elements.
 - Safety thermostat which ensures that the machine does not operate in the event of overheating or insufficient water.
- Tap with a safety valve and thermocouple.
- Safety thermostat to protect against overheating and lack of water.
- Temperature control (50 - 120 °C).
- Standard operating voltage of 400V-3N-50Hz
- Pressure control of the double wall through a pressure switch and a safety valve set to 0.5 bar, depression valve and gauge.
- Smoke extraction grille.
- Set of nozzles for different types of gas.

Foodservice | Large capacity cooking equipment

MODEL	CODE	POWER (KW)	TANKS		DIMENSIONS (mm)	€
			QUANTITY	CAPACITY (L)		
Directly heated gas						
CAG-1132	19084248	24,1	1	132	900x900x850	-
CAG-1223	19084249	39,1	1	223	1250x1000x925	-
CAG-2132	19084254	48,2	2	132+132	1800x900x850	-
CAG-2223	19084255	78,2	2	223+223	2500x1000x925	-
Directly heated electric						
CAE-1132	19084250	13,7	1	132	900x900x850	-
CAE-1223	19084251	25,0	1	223	1250x1000x925	-
CAE-2132	19084256	27,4	2	132+132	1800x900x850	-
CAE-2223	19084257	50,0	2	223+223	2500x1000x925	-
Indirectly heated steam						
CAIV-1132	19084252	0,1	1	132	900x900x850	-
CAIV-1223	19084253	0,1	1	223	1250x1000x925	-
CAIV-2132	19084258	0,2	2	132+132	1800x900x850	-
CAIV-2223	19084260	0,2	2	223+223	2500x1000x925	-



**Specific equipment
for non-modular
cooking.**



Find out more!



Access the website

Independent cooking

Grilling.....	113
— Basque Grill	113
— Robatas	114
Snack	115
— Gas counter top ranges	115
— Electric counter top deep fat fryers	116
— Gas fry-tops.....	117
Gas central ranges	118
Static ovens	119
Gas stockpot stoves with cast iron burner.....	119
Salamanders.....	120

All gas cooking equipment should be fitted with gas governors:
 LPG: 37 g/cm²
 Natural Gas: 20 g/cm²

Grilling | Basque Grill



General characteristics



- Offers precision cooking with natural charcoal. In addition, it can be used as a showcooking element for preparing dishes in front of the customer.
- Unit conceived for installation against wall.
- Surface top manufactured in 3 mm thick AISI-310 stainless steel, with rounded edges for easy cleaning.
- Mouth of grill raised above the surface top to allow the grill to be brought as close as possible to the embers and funnel the outlet of heat, for greater efficiency.
- Inner floor of the grill protected by refractory brick to insulate and concentrate the heat and improve efficiency.
- Sinks in the tank for easy withdrawal of the ashes.
- Includes an ash collection drawer by grill.
- Each grill has a lower zone with door (without shelf or rack), designed for housing a charcoal trolley (optional) or another trolley of the premises.
- Base with cut-out at the bottom back to bridge any skirting board on the wall.
- Unit clad in stainless steel down to the floor.

- With 4 height-adjustable feet and 4 castors.
- Back cover to hide the guide system and give an easier-to-clean finish. Includes grill guide, system of counterweights and fixed top grill.
- Top vents for optimum temperature diffusion.
- Grill constructed in stainless steel.
- Cooking grill height-adjustable by crank at front, making it possible to cook at different intensities to achieve the perfect cooking point. Includes counterweight to soften the adjustment action.
- Grill with large dimensions for greater versatility.

- Includes fat collection tray, easily removable without tools.
- The grill is tilted by 5°. This allows the fat to run along the grill by capillary motion to the fat collection tray. This prevents fat from falling onto the embers, which would cause flame-ups that alter the cooking of the food.
- Includes a second fixed grill at the top for temperature maintenance of the product.
- All the grills are dismantlable, to facilitate cleaning.

OPTIONAL ACCESSORY:

- Trolley for charcoal.
- Stainless steel drawer with reinforced upper part.
- With four wheels for easy movement.
- Designed for storing charcoal to feed the Basque grill mid-service more conveniently.
- Allows the charcoal to be stored in an external zone which does not affect the hygiene of the food handling areas.
- Dimensions: 370 x 380 x 536 mm.
- Interior capacity: 48 litres.

MODEL	CODE	GRILL DIMENSIONS (mm)	POWER IN CARBON EQUIVALENT (KW)	ELECTRICAL CONNECTION	ELECTRICAL POWER (W)	DIMENSIONS (mm)	€
 BGF-1000	19048685	650 x 560	4,6	230 V 1+N	25	800 x 870 x 1.500	-
 BGF-2000	19058110	2 x 650 x 560	9,2	230 V 1+N	50	1.600 x 870 x 1.500	-

Accessory: Trolley for charcoal

MODEL	CODE	CAPACITY (LITRES)	DIMENSIONS (mm)	€
 CBGF	19048692	48	370 x 380 x 536	-

Grilling | Robatas



General characteristics

- In Japanese cooking, robatayaki refers to food prepared in front of the customers, in which the ingredients, normally on brochettes, are grilled slowly over charcoal embers, in a way which is similar to a barbecue.
- Surface top manufactured in 2 mm thick AISI-304 stainless steel, with rounded edges for easy cleaning.
- Raised edge to allow cooking at barbecue level, with no superstructure.
- Very thick base in refractory steel to bear the charcoal, with perforations to improve air circulation and provide better combustion.
- Sinks in the tank for easy withdrawal of the ashes.
- Tank insulated with 30 mm of rock wool to prevent temperature loss and improve the ergonomics of your work.
- Outer body separated from the tank, in stainless steel, with perforations to allow external air flow that improves heat dissipation.

- Includes 1 or 2 drawers for ash collection.

CENTRAL UNIT MODEL

- Robata on stainless steel unit for independent use.
- Can be used from both sides.
- 150 mm free work-surface on both sides of the robata.
- Equipped with 4 wheels (two with brake).
- Includes folding frame on one side to accommodate two GN 1/9 trays.
- Comes with two large, multi-purpose drawers with reinforced guides.
- Superstructure in stainless steel profile with 3 different levels.
- 82 mm for cooking

- 239 mm for slow cooking of the core
- 396 mm to preheat or maintain the temperature of the product.
- Includes brochette rests, distance-adjustable to hold brochettes of different lengths.
- The superstructure is dismantable, without the need for tools, to allow cooking at barbecue level.



TABLETOP MODELS

- Robatas designed for installation onto furniture of the premises.
- Height of surface top of the supporting unit: 570 mm, to allow a working height of 900 mm.

- If positioned against a wall (whether of the building or a perimeter of the surface top), leave 5 cm between the Robata and the ends of the wall to allow heat dispersal.

ACCESSORIES:

- Poker for keeping the embers alive.
- Stainless steel mesh grill for cooking food without the use of brochettes
- Stainless steel grill for cooking and marking meat.

MODEL	CODE	GRILL DIMENSIONS (mm)	LEVELS OF THE SUPERSTRUCTURE	POWER IN CARBON EQUIVALENT (KW)	DIMENSIONS (mm)	€
 RGF-060	19048686	355 x 216	3	1	590 x 450 x 330	-
 RGF-100	19048688	800 x 216	3	2	1.107 x 450 x 330	-
 RGF-1000	19048689	800 x 216	3	2	1.107 x 850 x 900	-

Accessories

DESCRIPTION	CODE	€
ATTACHER	19048789	-
STAINLESS STEEL MESH GRILL	19048690	-
STAINLESS STEEL GRILL FOR MARKING MEAT	19048691	-

Gas counter top ranges











General characteristics

- Open hob and smooth hot-plate with safety valve and thermocouples.
- Pilots for ignition.
- Cast iron gratings and burners.
- Fat collector under the grill.

OVEN

- 1/1-GN oven in stainless steel, with tubular burner in stainless steel.
- Pilot and thermocouple.
- Thermostatic control (130 °C to 350 °C).

	MODEL	GAS	CODE	OPEN BURNERS		PLATE	OVEN		NEUTRAL CABINET	GAS POWER (KW)	DIMENSIONES (mm)	€
				4,41 KW	6,5 KW	4,41 KW	5,46 KW	GRILL				
DESKTOP												
	CG-200S	LPG	19005515	-	1	1	-	-	-	10,91	850x585x270	-
		NG	19005514									
	CG-200S SP	LPG	19005508	1	1	-	-	-	-	10,91	850x585x270	-
		NG	19005507									
	CG-300S	LPG	19005647	1	1	1	-	-	-	15,32	1.275x585x270	-
		NG	19006072									
	CG-300S SP	LPG	19005644	2	1	-	-	-	-	15,32	1.275x585x270	-
		NG	19005643									
OVEN GN 1/1												
	CG-210	LPG	19006930	-	1	1	1	-	-	16,37	850x585x850	-
		NG	19006854									
	CG-210 SP	LPG	19032464	1	1	-	1	-	-	16,37	850x585x850	-
		NG	19056053									
	CG-310	LPG	19007728	1	1	1	1	-	1	20,78	1.275x585x850	-
		NG	19007797									
	CG-310 SP	LPG	19036950	2	1	-	1	-	1	20,78	1.275x585x850	-
		NG	19036951									
GN 1/1 OVEN WITH ELECTRIC GRILL												
	CG-210 G	LPG	19006861	-	1	1	1	1	-	16,37	850x585x850	-
		NG	19006858									
	CG-210 SPG	LPG	19047990	1	1	-	1	1	-	16,37	850x585x850	-
		NG	19047991									
	CG-310 G	LPG	19007788	1	1	1	1	1	1	20,78	1.275x585x850	-
		NG	19007804									
	CG-310 SPG	LPG	19018757	2	1	-	1	1	1	20,78	1.275x585x850	-
		NG	19037436									

SP MODELS: Only grids. (No plate). **MODELS SPG:** Racks only,+ grill in the oven.

Accessories for ranges

DESCRIPTION	CODE	DIMENSIONES (mm)	€
Radiant plate - For burners of 4.1 kW - 425 x 350 mm	19036329	425x350	-

Electric counter top deep fat fryers



General characteristics













- Control by thermostat (60 °C to 195 °C).
- Safety thermostat. Safety switch for assembly.
- Removable shielded heating elements in stainless steel.
- Pilot light for heating.

DESKTOP MODEL:

- Micro de seguridad que corta el funcionamiento en caso de montaje incorrecto del conjunto.

PEDESTAL MODEL:

- Pilot light for heating. Cold zone.
- Removable shielded heating elements in stainless steel.
- Lower cabinet.
- Drainage cock.

	MODELS	CODE	BASKETS	TANK CAPACITY (L)			ELECTRIC POWER (kW)	VOLTAGE	DIMENSIONS (mm)	€	
				TOTAL	OIL	COLD ZONE					
DESKTOP											
		FE-4	19004652	1	4		3,00	230 V - 1+N	175x485x270	-	
		FE-6 - TRI	19004713	1	6		4,50	400 V - 3+N	265x485x270	-	
		FE-6 - MONO	19004709	1	6		4,50	230 V - 1+N	265x485x270	-	
		FE-8 - TRI	19004728	1	8		6,00	400 V - 3+N	355x485x270	-	
		FE-8 - MONO	19004749	1	8		6,00	230 V - 1+N	355x485x270	-	
WITH PEDESTAL											
		FE-18	19005130	1	18	12	6	9,00	-	355x520x850	-
		FE-25	19005404	1	25	17	8	12,70	-	430x585x850	-

Baskets for fryers

	DESCRIPTION	CODE	DIMENSIONS (mm)	€
	Kit 2 small baskets for FE-25	19036334	325x150x120	-

Gas fry-tops



General characteristics

- Countertop appliances.
- Burners in stainless steel with pilot.
- Fat collector under the plate.

	MODEL	GAS	CODE	PLATE			POWER		DIMENSIONS (mm)	€
				TYPE	AREAS	(DM ²)	(KCAL/H)	(KW)		
	PL-105 L	LPG	19005594	L	2	25	7.740	9,00	600x550x250	-
		NG	19005604							
	PL-105 C	LPG	19005607	L / C	2	25	7.740	9,00	600x550x250	-
		NG	19005606							
	PL-110 L	LPG	19006146	L	3	38	11.610	13,50	900x550x250	-
		NG	19006197							
	PL-110 R	LPG	19006203	R	3	38	11.610	13,50	900x550x250	-
		NG	19006202							
	PL-110 L+R	LPG	19006200	L+R	3	38	11.610	13,50	900x550x250	-
		NG	19006199							
	PL-110 C	LPG	19006205	L / C	3	38	11.610	13,50	900x550x250	-
		NG	19006206							



TYPE OF PLATES: L: Smooth hot-plate. / R: Ribbed hot-plate. / L+R: 1/2 smooth hot-plate - 1/2 ribbed hot-plate. / C: 50 microns thickness chromium coated steel sheeting hot-plate.

Gas central ranges



General characteristics

- Made of austenitic stainless steel.
- Open hobs and smooth hot-plates with safety valves and thermocouples.
- Pilots for ignition.
- Dimensions of the grills and plates: 425 x 350 mm.
- Cast iron gratings and burners.
- Fat collector under the grills.
- Front handrails.
- PASS-THROUGH OVENS:**
 - Made in stainless steel.
 - Three levels for trays.
 - Tubular burners in stainless steel.
 - Pilots and thermocouples.
- Thermostatic control (130 °C to 350 °C).
- IN OPTION:**
 - Column with hot and cold water tap (see accessories).



MODEL	GAS	CODE	BURNERS			OVEN (*)		POWER		DIMENSIONS (mm)	€
			4,41 KW	8,14 KW	10,5 KW	PASS	SIDE	(KCAL/H)	(KW)		
	LPG	19008069	2	1	1	1	0	32.300	37,53	850x1.140x850	-
	NG	19008068									
	LPG	19009073	4	1	1	1	1	44.600	51,81	1.400x1.140x850	-
	NG	19009027									
	LPG	19009365	4	2	2	2	0	64.600	75,06	2.000x1.140x850	-
	NG	19009373									

OVENS (*):

PASS OVEN: Pass-through oven 540 x 900 mm - Power: 10,071 kW.

SIDE OVEN: Side oven 540 x 440 mm GN-1/1 - Power: 5,46 kW.

Accessories

DESCRIPTION	CODE	DIMENSIONS (mm)	€
 Radiant plate - For the 4.000 kcal/h burners - 425 x 350 mm	19036329	425x350	-
 Water column - For CG-1002	19003595	-	-
Water column - For CG-1502	19003904	-	-
Water column - For CG-2002	19004670	-	-

Gas static ovens



General characteristics

- Burner in stainless steel.
- Three levels for trays in each oven.
- Pilot and thermocouple.
- Thermostatic control (130 °C - 350 °C).

GAS





- Independent upper and lower heating elements.

- Selector switch for the elements.

ELECTRIC

- Three levels for trays in each oven.

- Tray size GN-2/1.

MODEL	GAS	CODE	SIZE	LEVELS CAPACITY	GAS POWER (kW)	DIMENSIONS (mm)	€
	LPG	19006425	NG-2/1	3	8,60	850x900x560	-
	NG	19006424					
	LPG	19006420	NG-2/1	2x3	17,20	850x900x1.120	-
	NG	19006419					
	LPG	19007854	1.000x660	3	16,00	1.275x900x560	-
	NG	19007853					
		19006423	GN-2/1	3	6,00	850x900x560	-
		19008054	GN-2/1	2x3	12,00	850x900x1.120	-

Gas stockpot stoves with cast iron burner



General characteristics

- Cast iron burner.
- Cast iron grill.
- Pilot for ignition.
- Safety thermocouple.

MODEL	GAS	CODE	BURNER 13,6 - KW	GAS POWER		DIMENSIONS (mm)	€
				(KCAL/H)	(KW)		
	LPG	19007259	1	11.700	13,6	590x590x400	-
	NG	19005112					



Salamander



General characteristics



- Ideal for grilling, roasting or keep food warm before serving.
- Stainless steel construction, satin polished.
- Mobile top with adjustable height.
- Two independent zones.
- Grid and drip tray.

MODELOS DE TECHO MÓVIL:

- Tubular heating element, easy to cleaning.
- Energy regulator for temperature: range: 50 ÷ 300 °C.

MODELO ULTRA-RÁPIDO

- Heating elements of tungsten filament. The machine can be used 20 seconds after starting. The machine can be connected only when it will be used.
- Control panel with digital display for the cooking time (5 seconds to 99 minutes).
- Selector switch for heating elements that allows use the cooking zones independently.
- Possibility to work in continuous cycle.

MODEL	CODE	COOKING ZONES	COOKING AREA (mm)	VOLTAGE	POWER (KW)	DIMENSIONS (mm)	€	
MOBILE ROOF								
	SE-60-0	19036361	2	600x350	230 V - 1+N	4,0	600x450x500	-
	SE-60-4	19036362	2	600x350	400 V - 3+N	4,0	600x450x500	-
ULTRA-FAST								
	SEQ-60-4	19036363	2	600x450	400 V - 3+N	4,0	600x480x525	-

Accessories for salamanders

MODEL	CODE	DESCRIPTION	€
	SS-60	19036364 Support for wall mounting salamanders SE-60 and SEQ-60-4	-

0 | ADVANCE +

COOKING

The cooking control panel features several rows of icons and settings. The top row contains four icons: a white square with a red circle, a blue square with a white circle, a white square with a blue circle, and a white square with a blue circle. The second row includes a red bar graph, a blue square with a white circle, and a white square with a blue circle. The third row shows a white square with a blue circle, the number 23, a white triangle with a blue circle, and the number 140. The fourth row displays a white square with a blue circle, the number 1:31, a white triangle with a blue circle, and the number 1:31. The bottom row contains four icons: a white square with a blue circle, a white square with a blue circle, a white square with a blue circle, and a white square with a blue circle.



FAGOR



Ovens



Product flexibility
for all types
of needs and spaces.



Find out more!



Access the website



Sales brochure

Ovens

Advance Generation.....	125
— Advance + ovens.....	127
— Advance ovens.....	129
— Concept ovens	131

All ovens requiring water must be connected to a treated water supply when the local water at any time is over 7 HF / 4.0 HD, or has a Cl concentration over 150 mg/litre, or a salt content in excess of 30 mg/litre.

Ovens boilers must be drained down at the end of each shift. Manufacturers warranty will be void if this is not complied with.

LPG: 37 g/cm²
 Natural Gas: 20 g/cm²

Operating problems arising from faulty installation that does not meet these requirements will not be taken into account as a guarantee.

ADVANCE +

One of the best ovens
On the market

ADVANCE PLUS ovens are made for professionals who do not want to give up any functionality. They have the highest performance of the market, achieving a perfect balance between cooking quality, simplicity, efficiency and safety.

ADVANCE

The best value for money in ovens
with steam generators

ADVANCE ovens are the ideal solution for those professionals who need an affordable oven, with advanced features, guaranteeing perfect cooking results, safety and efficiency.

CONCEPT

Simple, economical,
Powerful and robust oven

CONCEPT ovens are the basic answer for any professional who is looking for a simple, economical, powerful and robust oven.

Functions and benefits



		COOKING QUALITY	EASY-OF-USE / WORKING SMART	ECO-FRIENDLY / USE SAVINGS	HYGIENE / SAFETY
	ECO-STEAMING	- Continuous supply of steam improves food quality and juiciness.		- Less lime build-up. - Reduced maintenance costs.	- Fresh, pure water supply guarantees hygiene and food safety.
	HA-CONTROL	- Uniform temperature ensures cooking consistency.		- Highly efficient gas burners. - Less CO emissions than other competitors.	- Combustion takes place outside chamber. - Silent gas burners.
	EZ-SENSOR	- Sensor probe guarantees high precision.	- Ergonomic, yet robust, sensor probe.	- High precision leads to reduced weight loss.	- High precision sensor improves food safety.
	FAGOR TOUCH		- Self-explanatory user interface. - Less training / recruiting expenses. - Wide viewing angle.	- Scratch-resistant. - Oil spill/water-repellent. - Reduced maintenance costs.	- Easy-to-clean.
	FAGOR COMBI-OS	- +40 recipes specially designed to ensure maximum quality.	- Infinite cooking families and recipes can be add, modified or adjust in any moment.	- Multi-tray allows flexible cooking during peak hours, saving time and money.	- HACCP control (Hazard Analysis and Critical Control Points) with Fagor USB.
	COMBI-CLEAN		- 5 different programs. - Retractable or external shower for manual cleaning.	- Flexibility in programs types saves money. - Efficient consumption of energy, chemicals and water.	- Optimum safety and hygiene standards. - 3 emergency quick rinses if cleaning process is aborted.

Table of functions and features

BASIC FEATURES	ADVANCE PLUS	ADVANCE	CONCEPT
Eco-Steamig	●	●	-
Steam generator with lime detector	●	●	-
Automatic emptying of the generator	●	●	-
Semiautomatic decalcification system	●	●	-
HA-Control	●	●	●
Exclusive bidirectional fan system	●	●	●
Cool-down (rapid cooling function)	●	●	●
"Auto-reverse" system to invert the fan direction	●	●	●
EZ-Sensor	●	●	●
Probe with temperature multi-sensor mechanism	●	●	●
Fagor Touch	Capacitive 8" TFT Touchscreen with front glass	Screen + Selector dial	Display 7 segments + 2 dials
Fagor CombiOS	●	-	-
Fagor Cooking	●	-	-
Fagor Easy	●	-	-
Fagor Multi-Tray System	●	-	-
Fagor USB	●	-	-
Cooking modes	4 + Humidity control	5	4
Fagor CombiClean (with programs of automatic washing)	● 5	● 1	● 1
OTHER FUNCTIONS			
Delayed programming (traditional cooking and Fagor cooking)	●	●	●
Delta cooking	●	●	●
Thermal stop (count down when temperature is reached)	●	●	-
Monitor App & Maintenance App (self-diagnostic alerts and errors)	●	●	●
Log file App (history of cycles)	●	●	●
Log file App (history of errors)	●	●	-
Configuration App (power-speed)	3 speed 2 power	3 speed 2 power	3 speed 2 power
Humidifier	●	●	●
Languages	33	25	-
HACCP	●	-	-
SAT mode	●	●	●
Trade show mode	●	●	●
Calibration	Auto	Auto	Manual
Rapid-close-door system (models 061,101 and 102)	●	●	●
Integrated rack-structure trolley (models 201 and 202)	●	●	Optional
Retractable shower	●	●	-
External shower	-	-	Optional
IPX-5 protection	●	●	●

Advance + | Ovens

ADVANCE PLUS ovens are made for professionals who do not want to give up any functionality. They have the highest performance of the market, achieving a perfect balance between cooking quality, simplicity, efficiency and safety.











General characteristics







- "Touch control" screen.
 - 5 cooking modes: steam, adjustable steam (Humidity control during cooking), combi, regeneration and convection (up to 300 °C).
 - Preheating option.
 - Fagor Easy cooking mode.
 - Fagor Cooking, range of cooking programmes.
 - Fagor Multi-Tray System, control cooking by tray.
 - Delayed programming for: Cooking / Low-temperature cooking / Washing.
 - Memory function: records the different cooking modes used.
 - 3 Speeds - 2 power ranges.
 - Cool-down chamber cooling system.
 - "Auto-reverse" system to reverse fan rotation.
 - 5 wash programmes.
 - Multisensor core temperature probe.
 - Core probe positioning aid to facilitate the process of temperature measurement in soft-consistency foods, avoiding it to fall out.
 - PC management software: History, recipes. HACCP, manuals...
 - HACCP cooking data recording system.
 - Steam generator equipped with limescale detector.
 - Steam generator automatically empties every 24 hours of cooking.
 - Semi-automatic limescale removal system.
 - Quick door-closing system (061, 101 and 102 models).
 - Integrated trolley (201 and 202 models).
 - Error detection system.
 - Repair service mode system.
 - IPX-5 protection.
 - Retractable shower.
 - Voltage - Electric models: 400 V - 3+N -230V 3 - 50/60 Hz.
 - Voltage - Gas models: 230V 1+N - 50 Hz or 60 Hz.
- Note: All ovens need neutral wire (N).
If no neutral wire in the electrical installation, you must order the accessory "Kit Neutral" with code 19013247 (see the chapter "Accessories").
- Includes:
- 2 kg Drum of detergent (AB BOOST), tu use with the self-cleaning program.
- Options:
- Left opening in models 061 and 101, electric.



Electric advance plus ovens

	MODEL	DOOR OPENING	CODE	CAPACITY	INCLUDES (*)	POWER (kW)	DIMENSIONS (mm)	€
	 APE-061	Right	19010970	6 GN-1/1 - 12 GN-1/2	-	10,20	898x867x846	-
	 APE-061 I	Left	19042535	6 GN-1/1 - 12 GN-1/2	-	10,20	898x867x846	-
	 APE-101	Right	19011023	10 GN-1/1 - 20 GN-1/2	-	19,20	898x867x1.117	-
	 APE-101 I	Left	19042541	10 GN-1/1 - 20 GN-1/2	-	19,20	898x867x1.117	-
	 APE-102	Right	19010816	10 GN-2/1 - 20 GN-1/1	-	31,20	1.130x1.063x1.117	-
	 APE-201	Right	19011025	20 GN-1/1 - 40 GN-1/2	CEB-201	38,40	929x964x1.841	-
	 APE-202	Right	19010954	20 GN-2/1 - 40 GN-1/1	CEB-202	62,40	1.162x1.074x1.841	-

Gas advance plus ovens

	MODEL	HZ.	CODE		CAPACITY	INCLUDES (*)	POWER		DIMENSIONES (mm)	€
			LPG	GN			GAS (kW)	ELECTRIC (kW)		
	 APG-061	50	19010042	19011886	6 GN-1/1 - 12 GN-1/2	-	12,00	1,20	898x922x846	-
		60	19011885	19011887						
	 APG-101	50	19011070	19011903	10 GN-1/1 - 20 GN-1/2	-	18,00	1,20	898x922x1.117	-
		60	19011902	19011904						
	 APG-102	50	19011096	19011912	10 GN-2/1 - 20 GN-1/1	-	35,00	1,20	1.130x1.063x1.117	-
		60	19011911	19011913						
	 APG-201	50	19011174	19011921	20 GN-1/1 - 40 GN-1/2	CEB-201	36,00	2,40	929x964x1.841	-
		60	19011920	19011922						
	 APG-202	50	19010040	19011930	20 GN-2/1 - 40 GN-1/1	CEB-202	65,00	2,40	1.162x1.074x1.841	-
		60	19011929	19011931						

Includes (*): CEB: Structure with incorporated loading trolley.

Advance | Ovens

ADVANCE ovens are the ideal solution for those professionals who need an affordable oven, with advanced features, guaranteeing perfect cooking results, safety and efficiency.



General characteristics

- Push-button and "Scrolling" controls.
 - 5 cooking modes: steam, adjustable steam, regeneration, combi and convection (up to 300 °C).
 - Preheating option.
 - Overnight cooking or low-temperature programme.
 - 3 Speeds - 2 power ranges.
 - Cool-down chamber cooling system.
 - "Auto-reverse" system to reverse fan rotation.
 - Multisensor core temperature probe.
 - Core probe positioning aid to facilitate the process of temperature measurement in soft-consistency foods, avoiding it to fall out.
 - Steam generator equipped with limescale detector.
 - Steam generator automatically empties every 24 hours of cooking.
 - Semi-automatic limescale removal system.
 - Wash program for the cooking chamber (Automatic Cleaning).
 - Quick door-closing system (061, 101 and 102 models).
 - Integrated trolley (201 and 202 models).
 - Error detection system.
 - Repair service mode system.
 - IPX-5 protection.
 - Retractable shower.
 - Voltage - Electric models:
 - 400 V - 3+N -230V 3 - 50/60 Hz.
 - 230V 1N 50/60Hz (AE-0623)
 - Voltage - Gas models:
 - 230V 1+N - 50Hz (standard) or 60 Hz.
- Note: All ovens need neutral wire (N).
If no neutral wire in the electrical installation, you must order the accessory "Kit Neutral" with code 19013247 (see the chapter "Accessories").
- Options:
- Left opening in models 061 and 101, electric.

ADVANCE
OPTIMA



Electric advance ovens

	MODEL	DOOR OPENING	CODE	CAPACITY	INCLUDES (*)	POWER (kW)	DIMENSIONS (mm)	€
	AE-0623	Right	19048005	6 GN-2/3	-	5,80	657x563x570	-
New	AE-0623*	Right	19079272	6 GN-2/3	-	5,80	657x563x570	-
	AE-061	Right	19010984	6 GN-1/1 - 12 GN-1/2	-	10,20	898x867x846	-
	AE-061 I	Left	19042537	6 GN-1/1 - 12 GN-1/2	-	10,20	898x867x846	-
	AE-101	Right	19011021	10 GN-1/1 - 20 GN-1/2	-	19,20	898x867x1.117	-
	AE-101 I	Left	19042540	10 GN-1/1 - 20 GN-1/2	-	19,20	898x867x1.117	-
	AE-102	Right	19011020	10 GN-2/1 - 20 GN-1/1	-	31,20	1.130x1.063x1.117	-
	AE-201	Right	19010557	20 GN-1/1 - 40 GN-1/2	CEB-201	38,40	929x964x1.841	-
	AE-202	Right	19010961	20 GN-2/1 - 40 GN-1/1	CEB-202	62,40	1.162x1.074x1.841	-

*230V 1N 50/60Hz

Gas advance ovens

	MODEL	HZ.	CODE		CAPACITY	INCLUDES (*)	POWER		DIMENSIONES (mm)	€
			LPG	GN			GAS (kW)	ELECTRIC (KW)		
	AG-061	50	19011040	19011882	6 GN-1/1 - 12 GN-1/2	-	12,00	1,20	898x922x846	-
		60	19011881	19011883						
	AG-101	50	19010041	19011899	10 GN-1/1 - 20 GN-1/2	-	18,00	1,20	898x922x1.117	-
		60	19011898	19011901						
	AG-102	50	19011126	19011909	10 GN-2/1 - 20 GN-1/1	-	35,00	1,20	1.130x1.063x1.117	-
		60	19011908	19011910						
	AG-201	50	19011193	19011918	20 GN-1/1 - 40 GN-1/2	CEB-201	36,00	2,40	929x964x1.841	-
		60	19011917	19011919						
	AG-202	50	19011108	19011927	20 GN-2/1 - 40 GN-1/1	CEB-202	65,00	2,40	1.162x1.074x1.841	-
		60	19011926	19011928						

Includes (*) : CEB: Structure with incorporated loading trolley.

Concept | Ovens

CONCEPT ovens are the basic answer for any professional who is looking for a simple, economical, powerful and robust oven.



General characteristics

- Digital push-button controls + Two "Scroll" buttons.
- 4 cooking modes: steam, regeneration, combi and convection (up to 300 °C).
- Multisensor core temperature probe.
- Core probe positioning aid to facilitate the process of temperature measurement in soft-consistency foods, avoiding it to fall out.
- Preheating option.
- 2 Speeds - 2 power ranges.
- Cool-down chamber cooling system.
- Wash program for the cooking chamber

(Automatic Cleaning).

- "Auto-reverse" system to reverse fan rotation.
- Quick door-closing system (061 and 101 models).
- Error detection system.
- Repair service mode system.
- IPX-5 protection.
- Voltage - Electric models:
-400 V - 3+N -230V 3 - 50/60 Hz.
-230V 1N 50/60Hz (ACE-0623)

- Voltage - Gas models:

230V 1+N - 50Hz (standard) or 60 Hz.

Note: All ovens need a good neutral connection.

If no neutral wire in the electrical installation, you must order the accessory "Kit Neutral" with code 19013247 (see the chapter "Accessories").

Ask Fagor Industrial.

Options:

- Left opening in models 061 and 101, electric.

CONCEPT
OPTIMA



ACE-0623



ACE-061



ACE-101



ACE-102



ACE-201



ACE-202

Electric concept ovens

	MODEL	DOOR OPENING	CODE	CAPACITY	INCLUDES (*)	POWER (kW)	DIMENSIONS (mm)	€
	ACE-0623	Right	19048181	6 GN-2/3	-	5,80	657x563x570	-
	ACE-0623*	Right	19079271	6 GN-2/3	-	5,80	657x563x570	-
	ACE-061	Right	19010988	6 GN-1/1 - 12 GN-1/2	-	10,20	898x867x846	-
	ACE-061 I	Left	19042538	6 GN-1/1 - 12 GN-1/2	-	10,20	898x867x846	-
	ACE-101	Right	19011022	10 GN-1/1 - 20 GN-1/2	-	19,20	898x867x1.117	-
	ACE-101 I	Left	19042539	10 GN-1/1 - 20 GN-1/2	-	19,20	898x867x1.117	-
	ACE-102	Right	19011028	10 GN-2/1 - 20 GN-1/1	-	31,20	1.130x1.063x1.117	-
	ACE-201	Right	19011049	20 GN-1/1 - 40 GN-1/2	-	38,40	929x964x1.841	-
	ACE-201-C	Right	19013091	20 GN-1/1 - 40 GN-1/2	CEB-201	38,40	929x964x1.841	-
	ACE-202	Right	19010991	20 GN-2/1 - 40 GN-1/1	-	62,40	1.162x1.074x1.841	-
	ACE-202-C	Right	19017132	20 GN-2/1 - 40 GN-1/1	CEB-202	62,40	1.162x1.074x1.841	-

*230V 1N 50/60Hz

Gas concept ovens

	MODEL	HZ.	CODE		CAPACITY	INCLUDES (*)	POWER		DIMENSIONS (mm)	€
			LPG	GN			GAS (kW)	ELECTRIC (KW)		
	ACG-061	50	19011043	19011615	6 GN-1/1 - 12 GN-1/2	-	12,00	1,20	898x867x846	-
		60	19011617	19011880						
	ACG-101	50	19011071	19011893	10 GN-1/1 - 20 GN-1/2	-	18,00	1,20	898x867x1.117	-
		60	19011892	19011894						
	ACG-102	50	19011127	19011906	10 GN-2/1 - 20 GN-1/1	-	35,00	1,20	1.130x1.063x1.117	-
		60	19011905	19011907						
	ACG-201	50	19011234	19011915	20 GN-1/1 - 40 GN-1/2	-	36,00	2,40	929x964x1.841	-
		60	19011914	19011916						
	ACG-201-C	50	19031191	19034322	20 GN-1/1 - 40 GN-1/2	CEB-201	36,00	2,40	929x964x1.841	-
		60	19034324	19034323						
	ACG-202	50	19011124	19011924	20 GN-2/1 - 40 GN-1/1	-	65,00	2,40	1.162x1.074x1.841	-
		60	19011923	19011925						
	ACG-202-C	50	19020731	19034325	20 GN-2/1 - 40 GN-1/1	CEB-202	65,00	2,40	1.162x1.074x1.841	-
		60	19034326	19034327						

Includes (*) : CEB: Structure with incorporated loading trolley.



Cost savings, optimizing resources, safety and hygiene, and a product just been made

Optimise the work
and productivity of a
professional kitchen.



Find out more!



Access the website

Cook & Chill

Cook & Chill process	135
Cook & Chill solutions	136
Blast chillers	137
Vacuum packers.....	139

All ovens requiring water must be connected to a treated water supply when the local water at any time is over 7 HF / 4.0 HD, or has a Cl concentration over 150 mg/litre, or a salt content in excess of 30 mg/litre.

Ovens boilers must be drained down at the end of each shift. Manufacturers warranty will be void if this is not complied with.

LPG: 37 g/cm²
Natural Gas: 20 g/cm²

Operating problems arising from faulty installation that does not meet these requirements will not be taken into account as a guarantee.

Our Cook & Chill Solutions

Cook & chill 061

40 ÷ 60 Meals per day



Cook & chill 101

60 ÷ 100 Meals per day



Cook & chill 102

100 ÷ 150 Meals per day



COOK & CHILL 061 SOLUTIONS



ELECTRIC OVEN
APE-061 19010970
AE-061 19010984

GAS OVEN (*)
APG-061
AG-061



STACKING KIT 061
Electric and gas models
ACG 19020971

Gas models
APG and AG 19020972



BLAST CHILLER ATA-061
19018754 (50 Hz)
19030606 (60 Hz)



VACUUM PACKER (**)
SVS-1-310/8 19074224
SVS-1-410/10 19074237



TROLLEY FOR REMOVABLE
RACKS
CP-11-R 19018752



REMOVABLE TRAY HOLDER
EB-061 19011559

REMOVABLE PLATE RACK
EP-061 19013353



RAIL GUIDES FOR STRUCTURE
GE-101 19011569



THERMAL COVER LTE-061
EP-061 19011738

COOK & CHILL 101 SOLUTIONS



ELECTRIC OVEN
APE-101 19011023
AE-101 19011021

GAS OVEN (*)
APG-101
AG-101

Support SH-11
19013205

CLOSED Support
GUIDES SH-11-B C
19073923

Support GUIDES SH-
11-B
19013401

CLOSED Support
GUIDES AND DOORS
SH-11-B C P
19073674



BLAST CHILLER ATA-101
19020653 (50 Hz)
19030442 (60 Hz)



VACUUM PACKER (**)
SVS-1-410/20 19074242
SVS-2-410/20 19075911



TROLLEY FOR REMOVABLE
RACKS
CP-11 19013352



REMOVABLE TRAY HOLDER
EB-101 19011561

REMOVABLE PLATE RACK
EP-101 19013354



RAIL GUIDES FOR STRUCTURE
GE-101 19011569



THERMAL COVER LTE-101
19011739

COOK & CHILL 102 SOLUTIONS



Electric oven
APE-102 19010816
AE-102 19011020

GAS OVEN (*)
APG-102
AG-102

Support SH-102
19013212

CLOSED Support
GUIDES SH-102-B C
19076582

Support GUIDES SH-
102-B
19013403

CLOSED Support
GUIDES AND DOORS
SH-102-B C P
19076506



BLAST CHILLER ATA-102
19033204 (50 Hz)
19033245 (60 Hz)



VACUUM PACKER (**)
SVS-2-410/20 19075911
SVP-2-455/25 19075913
SVP-2-520/25 19074279



TROLLEY FOR REMOVABLE
RACKS
CP-102 19013355



REMOVABLE TRAY HOLDER
EB-102 19011562

REMOVABLE PLATE RACK
EP-102 19013356



RAIL GUIDES FOR STRUCTURE
GE-102 19011570



THERMAL COVER LTE-102
19011740

(*): Consult gases and frequencies.
(**): Consult the same models with gas.

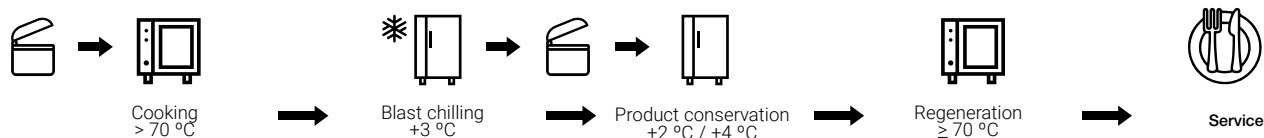

Cook & chill 201

150 ÷ 200 Meals per day

Cook & chill 202

200 ÷ 360 Meals per day



COOK & CHILL 201 SOLUTIONS



ELECTRIC OVEN
APE-201 19011025
AE-201 19010557

GAS OVEN (*)
APG-201
AG-201

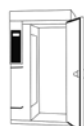

BLAST CHILLER
CSK-201

BLAST CHILLER AND FREEZER
CMK-201



VACUUM PACKER (**)

SVP-2-505/63 19075916
SVP-2-620/25 19074280



LOADING TROLLEY
FOR TRAYS CEB-201
19011551



LOADING TROLLEY
FOR PLATES CEP-201
19013357



THERMAL COVER LTE-201
19011741

COOK & CHILL 202 SOLUTIONS



ELECTRIC OVEN
APE-202 19010954
AE-202 19010961

GAS OVEN (*)
APG-202
AG-202



BLAST CHILLER
CSK-202

BLAST CHILLER AND FREEZER
CMK-202



VACUUM PACKER (**)

SVP-2-560/100 19075919
SVP-2-950/100 19074281



LOADING TROLLEY
FOR TRAYS CEB-202
19011550



LOADING TROLLEY
FOR PLATES CEP-202
19011552



THERMAL COVER LTE-202
19011742

(*): Consult gases and frequencies.

(**): Consult the same models with gas.

ATA series | Blast chillers

Thanks to their design, ATA compact blast chillers can be combined with ADVANCE range ovens. This combo equipment known as Cook & Chill is very convenient when you want to move around in the kitchen, reduces hazards, is more comfortable for cooks and provides an enhanced performance.



ATA series

Stacking 6GN 1/1

Online solution



ATA-061

ATA-101

ATA-102

ATA 061 + OVEN

ATA 102 BLAST CHILLER + OVEN

Stacking solution 6G-GN1/1 for reduced spaces.

Online solution for oven units + blast chiller sizes 101 and 102.

General characteristics

- Mixed models, for chiller blasting (+3 °C) or freezing cycles (-18 °C).
- There two working options both for chiller blasting and freezing:
- Power cycle: for over 2 cm thick compact products.
- Soft cycle: for less than 2 cm thick or low density products. The cycle is run in two programmed stages. The soft cycle prevents frost on the product.
- Cycle duration:
 - Refrigerating cycle: 90 minutes.
 - Freezing cycle: 240 minutes.
- Electronic timer and temperature sensor.
- The cycles can be controlled by time or by

- temperature according to the reading of the temperature sensor inside the product (time control is automatically applied when no probe is used).
- When the refrigerating cycle is over, the equipment works as a refrigerated cabinet, and the temperature remains between +2 and +4 °C, or as a freezer, with temperatures under -18 °C.
- Hermetically sealed compressor with ventilated condenser.
- R-452A ecological cooling (CFC free).
- 60 mm thick injected polyurethane insulation.
- 40 kg density. CFC free.

- Copper piping and aluminium flaps evaporator.
- Forced draught cooling system.
- Automatic defrosting device activated by the user, and water evaporation device without power consumption (all models except for ATA-102).
- Inner tray slides included.

Ordering options:

- Heated probe.
- USB port.

MODEL	HZ.	CODE	LEVELS			PRODUCTION (KG/CYCLE) *		TENSION	POWER (W)		DIMENSIONS (mm)	€
			GN-1/1	GN-2/1	60X40	REFRIG.	FREEZING		ELECTRIC	COOLING		
ATA-061	50	19018754	6	-	6	27	21	230V-1N	1.600	990	900x935x1.105	-
	60	19030606										
ATA-101	50	19020653	10	-	10	50	30	230V-1N	2.000	1.300	900x935x1.766	-
	60	19030442										
ATA-102	50	19033204	20	10	20	100	65	400V-3N	2.300	2.850	1.200x1130x1.766	-
	60	19033749										

(*) Productions calculated in accordance with EN 17032

Options - factory fitted

DESCRIPTION	€
Heated probe	-
USB port	-

Vacuum packers

Complete the process

The constant evolution of culinary techniques requires reliable conservation and elaboration systems that use technological innovations. The new generation of industrial packaging machines is extremely precise thanks to the sensor control and Busch pumps, the undisputed leader of vacuum pumps, which are known for their reliability and quality.

The new professional vacuum packers by Fagor Industrial make it possible to increase the shelf life of foods, preserving their aroma and organoleptic qualities, as well as broadening cooking possibilities and optimising culinary processes.



General characteristics

- Vacuum packers with digital controls, controlled by sensor.
- Made of stainless steel, no sharp corners and rounded edges.
- 2 units of high-quality polycarbonate fill sheets.
- High-precision microprocessor which controls the vacuum percentage of the chamber, therefore enabling precise and consistent results at all times, regardless of the type/quantity of the product to be packaged.
- Digital control panel with display included.
- Easily programmable memory for 10 programmes.
- Possibility of performing additional 60" vacuum.
- Possibility of packaging liquids.
- H2Oout programme to dehumidify the pump.
- Programme for external packing both in bags and containers.
- All models include Busch pumps.
- Reed switch for automatic start the vacuum cycle once the lid is closed.
- Lid with gas shock absorbers for smooth opening.
- Piston with two positions: operation and standby. In standby position, the lid is not stressed by the piston, ensuring that it does not become deformed over time.
- Cable-free sealing bars with pneumatic pistons. Their shape ensures a hermetic seal even when using multiple packaging (2-3 bags).
- Protection against possible entry of water into the machine.
- Thanks to the injection of inert gas, the G models make it possible to package delicate or soft products.
- Oil level indicator.
- Audio and visual alarms: vacuum alarm (warning if the configured vacuum level is not reached) and oil change.
- Visualisation of the complete machine cycles.
- Tilting opening system which enable easy access to all parts for maintenance.
- Internal electronic cards, protected with hermetic casing (waterproof and flame-retardant).
- Easy to replace teflon of the sealing bar."

MODEL	CODE	N° WELDING BARS	BAR LENGTH (mm)	PUMP CAPACITY (M3/H)	CHAMBER DIMENSIONS (mm)	POWER (KW)	DIMENSIONS (mm)	€
SVS-1-310/8	19074224	1	310 _	8	332 x 335 x 170	600	395 x 490 x 374	-
SVS-1-310/8 G	19075908	1	310 _	8	332 x 335 x 170	600	395 x 490 x 374	-
 SVS-1-410/10	19074237	1	410 _	10	441 x 449 x 170	750	535 x 591 x 438	-
SVS-1-410/10 G	19075909	1	410 _	10	441 x 449 x 170	750	535 x 591 x 438	-
SVS-1-410/20	19074242	1	410 _	20	441 x 449 x 170	1000	535 x 591 x 438	-
SVS-1-410/20 G	19075910	1	410 _	20	441 x 449 x 170	1000	535 x 591 x 438	-
SVS-2-410/20	19075911	2	410 +410 =	20	441 x 449 x 170	1000	535 x 591 x 438	-
SVS-2-410/20 G	19075912	2	410 +410 =	20	441 x 449 x 170	1000	535 x 591 x 438	-
SVP-2-455/25	19075913	2	455 + 455 =	25	485 x 550 x 175	1200	600 x 710 x 1035	-
SVP-2-455/25 G	19075914	2	455 + 455 =	25	485 x 550 x 175	1200	600 x 710 x 1035	-
SVP-2-520/25	19074279	2	520 + 520	25	485 x 550 x 175	1200	600 x 710 x 1035	-
SVP-2-520/25 G	19075915	2	520 + 520	25	485 x 550 x 175	1200	600 x 710 x 1035	-
SVP-2-505/63	19075916	2	505 + 505	63	650 x 535 x 200	1500	765 x 710 x 1050	-
SVP-2-505/63 G	19075917	2	505 + 505	63	650 x 535 x 200	1500	765 x 710 x 1050	-
SVP-2-620/63	19074280	2	620 + 620 =	63	650 x 535 x 200	1500	765 x 710 x 1050	-
SVP-2-620/63 G	19075918	2	620 + 620 =	63	650 x 535 x 200	1500	765 x 710 x 1050	-
SVP-2-560/100	19075919	2	560 + 560	100	980 x 585 x 230	2500	1100 x 800 x 1070	-
SVP-2-560/100 G	19075920	2	560 + 560	100	980 x 585 x 230	2500	1100 x 800 x 1070	-
SVP-2-950/100	19074281	2	950 + 950 =	100	980 x 585 x 230	2500	1100 x 800 x 1070	-
SVP-2-950/100 G	19075921	2	950 + 950 =	100	980 x 585 x 230	2500	1100 x 800 x 1070	-

G: Models with inert gas inlet

Accessories

Complete the process

Fagor Industrial packaging machines are complemented by a large catalogue of accessories to meet the most demanding requirements. They allow users to make the most of packaging machines, improving the ergonomics and flexibility of operations in professional kitchens.

CODE	DESCRIPTION	SUITABLE FOR MODELS	€
Trolleys for tabletop models			
19076888	Trolley with 4 wheels 590x550x610h mm	SVS-1-310/8	-
19076889	Trolley with 4 wheels 690x730x610h mm	SVS-1-410/10 SVS-1-410/20	-
Tilted flat shelves for packaging liquids			
19076890	Stainless steel tilted flat shelf for packaging liquids	SVS-1-310/8	-
19076891	Stainless steel tilted flat shelf for packaging liquids	SVS-1-410/10 SVS-1-410/20	-
19076892	Stainless steel tilted flat shelf for packaging liquids	SVP-2-520/25	-
19076893	Stainless steel tilted flat shelf for packaging liquids	SVP-2-620/63	-
19076897	Stainless steel filter for liquids		-
Suction tube for emptying into containers			
19076894	Suction tube for emptying into external containers		-
SYV valve for core temperature probe			
19076895	Core temperature probe for vacuum cooking inox.		-
19076896	Set of valve seals (10 pieces)		-





One of the largest
ranges on the market.



Find out more!



Access the website

Accessories

Specific accessories	145
Gastronorm containers, trays and grills	151
Cooking accessories.....	155
Stacking kits	156
Conversion kits.....	157
Cleaning accessories.....	158

All ovens requiring water must be connected to a treated water supply when the local water at any time is over 7 HF / 4.0 HD, or has a Cl concentration over 150 mg/litre, or a salt content in excess of 30 mg/litre.

Ovens boilers must be drained down at the end of each shift. Manufacturers warranty will be void if this is not complied with.

LPG: 37 g/cm²
Natural Gas: 20 g/cm²

Operating problems arising from faulty installation that does not meet these requirements will not be taken into account as a guarantee.

Specific accessories

Accessories for 0623 OVENS



SH-23

SH-23-R

SH-23-B





SH-23-RB

MSH-23

SHP-23





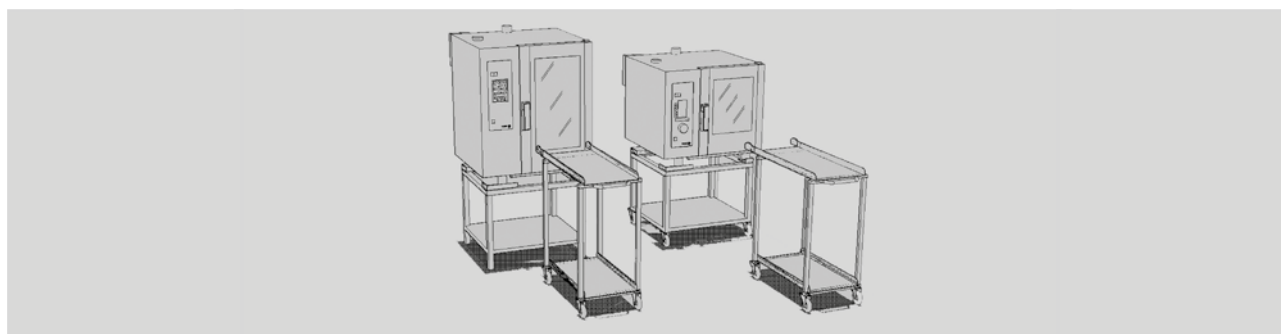

STHH-23

EX-23 + SH-23

MODEL	CODE	DESCRIPTION	DIMENSIONS (mm)	€	
SUPPORTS					
	SH-23	19058933	SUPPORT Height = 850 mm. 2 racks.	625x415x850	-
	SH-23-R	19058940	MOBILE SUPPORT Height = 850 mm. 2 racks. 4 castors, two with brake. .	625x415x850	-
	SH-23-B	19058941	SUPPORT Height = 850 mm. 2 racks. 2 kit guides for 4 GN-2/3 levels. (Heigh between guides 62 mm)	625x415x850	-
	SH-23-RB	19058943	MOBILE SUPPORT Height = 850 mm. 2 racks. Closed side. 2 kit guides for 4 GN-2/3 levels. (Heigh between guides 62 mm) 4 castors, two with brake.	625x415x850	-
	SH-23-RBM	19079266	Mobile cart for outdoor use, suitable for catering open-air meals and banquets. Includes 2 15-litre containers, one for drinking water and another for waste water, so it only needs to be connected to the electricity.	1540 x 710 x 850	-
	MSH-23	19059319	NIVELABLE SUPPORT to place the oven over a stand or worktop	625x415X150	-
WALL SUPPORT					
	SHP-23	19059282	WALL SUPPORT. With hanging elements..		-
EXHAUST HOOD					
	EXH-23	19073213	EXHAUST HOOD for 0623 oven. With Speed control.	660x600x255	-
KIT STACKING					
	STHH-23	19059364	KIT STACKING - TWO OVENS 0623 model		-
	STHA-23	19066344	KIT STACKING - OVEN 0623 model + BLAST CHILLER 031 size		-
OTHER ACCESSORIES					
	GD-AD	19004504	SHOWER TAP - External installation. (Only for ACE and ACG versions FROM CONCEPT RANGE)		-
	TRAYS		See standard accessories and trays		-

Accessories for 061 and 101 models

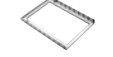



	MODEL	CODE	DESCRIPTION	DIMENSIONS (mm)	€
SUPPORTS					
	SH-11	19013205	SUPPORT Height = 650 mm.	815x724x650	-
	SH-11-R	19013208	SUPPORT WITH CASTORS Height = 650 mm. 4 castors, two with brake.	815x724x650	-
	SH-11-B	19013401	SUPPORT - Height = 650 mm. 2 kit guides for 6 GN-1/1 levels. (Heigh between guides 68 mm)	815x724x650	-
	SH-11-RB	19013402	SUPPORT WITH CASTORS - Height = 650 mm. 4 castors, two with brake. 2 kit guides for 6 GN-1/1 levels. (Heigh between guides 68 mm)	815x724x650	-
	SH-11-B C	19073923	CLOSED SUPPORT WITH GUIDES height = 650 mm. Equipped with 2 6-level GN-1/1 guide kits * Only suitable for electric ovens.	815x724x650	-
	SH-11-B C P	19073674	CLOSED SUPPORT WITH GUIDES AND DOORS height = 650 mm. Equipped with 2 6-level GN-1/1 guide kits * Only suitable for electric ovens.	815x724x650	-
	ACH-11	19011733	HOT SUPPORT - Height = 650 mm. Swing doors. Forced convection.	815x725x650	-
TROLLEYS FOR STRUCTURES					
	CP-11	19013352	(*) TROLLEY FOR STRUCTURE To put 061 and 101 structures in the ovens placed over SH-11 supports.	530x840x1.020	-
	CP-11-R	19018752	(*) REGULABLE TROLLEY FOR STRUCTURE To put 061 and 101 structures in the ovens placed over other supports at different height.	530x840x1.020	-
	GE-101	19011569	RAIL GUIDES FOR STRUCTURE To place in the cooking chamber For structures 061 and 101.	420x590x113	-
OTHER ACCESSORIES					
	GD-AD	19004504	SHOWER TAP (Only for ACE and ACG versions FROM CONCEPT RANGE)	-	-
	AP-10	19004439	KIT OF FASTENING ELEMENTS Kit of pieces to fix the legs to a worktop. (Not necessary for SH ovens supports).	-	-
	Z-11-E	19020762	Kit LOWER COVER to place an ACG 061 or 101 electric oven over top.	-	-
	Z-11-G	19020763	Kit LOWER COVER to place an AG or APG 061 or 101 gas oven over top.	-	-
		19069736	DOUBLE-LOCKING FASTENING KIT	-	-

(*) : Obligatory use of GE-101 structure guides.

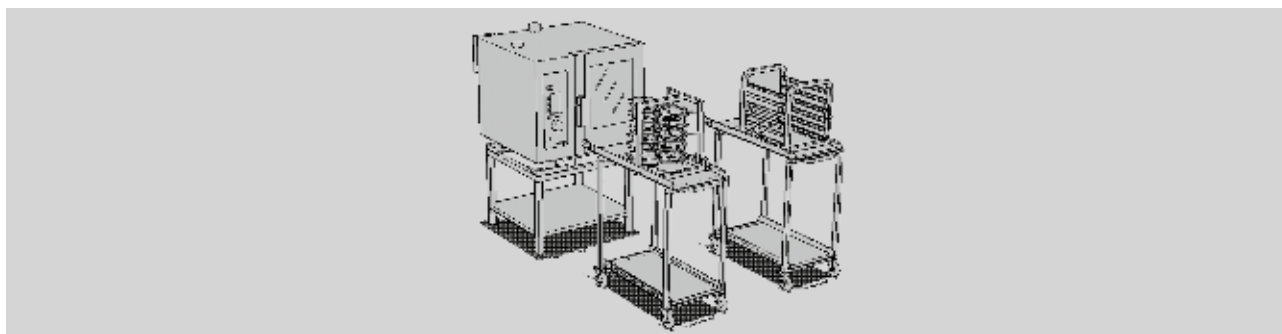

Accessories for 061 models

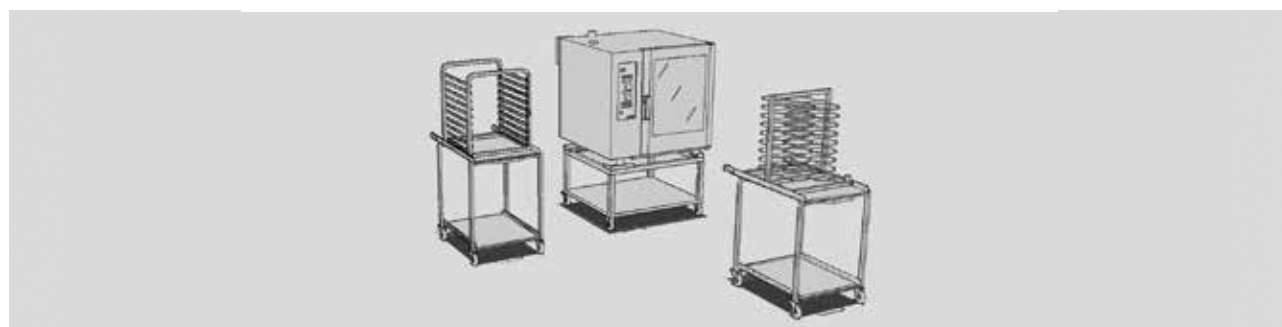

MODEL	CODE	DESCRIPTION	DIMENSIONS (mm)	€	
STRUCTURES					
	EB-061	19011559	STRUCTURE FOR TRAYS Capacity for 6 GN-1/1 levels or 12 GN-1/2. It is necessary to install with GE-101 rail guides. (Height between trays 62 mm)	398x584x458	-
	EP-061	19013353	STRUCTURE FOR PLATES Capacity for 18 dishes Ø 31 cm. It is necessary to install with GE-101 rail guides.	422x635x455	-
OTHER ACCESSORIES					
	LTE-061	19011738	THERMICAL COVER For structure EP-061. Maintains food temperature 20'.	405x500x440	-
	GP-061	19011982	Kit PASTRY GUIDES 5 levels 60 x 40 cm. (Height between trays 85 mm)	-	-

Accessories for 101 models



MODEL	CODE	DESCRIPTION	DIMENSIONS (mm)	€	
STRUCTURES					
	EB-101	19011561	STRUCTURE FOR TRAYS Capacity for 10 GN-1/1 levels or 20 GN-1/2. It is necessary to install with GE-101 rail guides. (Height between trays 62 mm)	398x584x730	-
	EP-101	19013354	STRUCTURE FOR PLATES Capacity for 30 dishes Ø 31 cm. It is necessary to install with GE-101 rail guides.	422x635x725	-
OTHER ACCESSORIES					
	LTE-101	19011739	THERMICAL COVER For structure EP-101. Maintains food temperature 20'.	405x500x700	-
	GP-101	19011983	Kit PASTRY GUIDES 8 levels 60 x 40 cm. (Height between trays 85 mm)	-	-

Accessories for 102 models

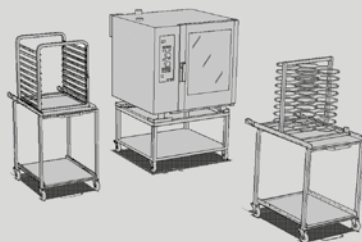

MODEL	CODE	DESCRIPTION	DIMENSIONS (mm)	€	
SUPPORTS					
	SH-102	19013212	SUPPORT Height = 650 mm.	1.043x870x650	-
	SH-102-R	19013211	SUPPORT WITH CASTORS Height = 650 mm. 4 castors, two with brake.	1.043x870x650	-
	SH-102-B	19013403	SUPPORT - Height = 650 mm. Two kit guides, one for 6 GN-1/1 levels and another one for 6 GN-2/1 levels. (Height between guides 68 mm)	1.043x870x650	-
	SH-102-RB	19013404	SUPPORT WITH CASTORS - Height = 650 mm. 4 castors, two with brake. Two kit guides, one for 6 GN-1/1 levels and another one for 6 GN-2/1. (Height between guides 68mm)	1.043x870x650	-
	SH-102-B C	19076582	CLOSED SUPPORT WITH GUIDES height = 650 mm. Two kit guides, one for 6 GN-1/1 levels and another one for 6 GN-2/1 levels. (Height between guides 68 mm)	1.043x870x650	-
	SH-102-B C P	19076506	CLOSED SUPPORT WITH GUIDES AND DOORS height = 650 mm. Two kit guides, one for 6 GN-1/1 levels and another one for 6 GN-2/1 levels. (Height between guides 68 mm)	1.043x870x650	-
	ACH-102	19011736	HOT SUPPORT - Height = 650 mm. Swing doors. Forced convection.	1.050 x925x650	-
STRUCTURES AND TROLLEYS					
	EB-102	19011562	STRUCTURE FOR TRAYS Capacity for 10 GN-2/1 levels or 20 GN-1/1. It is necessary to install with GE-102 rail guides. (Height between trays 62 mm)	605x714x730	-
	EP-102	19013356	STRUCTURE FOR PLATES Capacity for 52 dishes Ø 31 cm. It is necessary to install with GE-102 rail guides.	620x790x720	-
	GE-102	19011570	RAIL GUIDES FOR STRUCTURE To place in the cooking chamber. For structures 102 type.	630x790x113	-
	CP-102	19013355	(*) TROLLEY FOR STRUCTURE To put 102 type structures in the ovens placed over SH-102 supports.	742x965x1.018	-
	CP-102-R	19018751	(*) REGULABLE TROLLEY FOR STRUCTURE To put 102 type structures in the ovens placed over other supports at different height.	742x965x1.018	-
OTHER ACCESSORIES					
	LTE-102	19011740	THERMICAL COVER For structure EP-102. Maintains food temperature 20'.	610x720x710	-
	GP-102	19012134	Kit PASTRY GUIDES 16 levels 60 x 40 cm. (Height between trays 85 mm)	-	-
	GD-AD	19004504	SHOWER TAP (Only for ACE and ACG versions FROM CONCEPT RANGE).	-	-
	AP-10	19004439	KIT OF FASTENING ELEMENTS Kit of pieces to fix the legs to a worktop. (Not necessary for SH ovens supports).	-	-
	Z-102	19020764	Kit LOWER COVER to place an 102 oven over top.	-	-
		19069736	DOUBLE-LOCKING FASTENING KIT	-	-

(*) :Obligatory use of GE-102 structure guides.

Accessories for 201 models

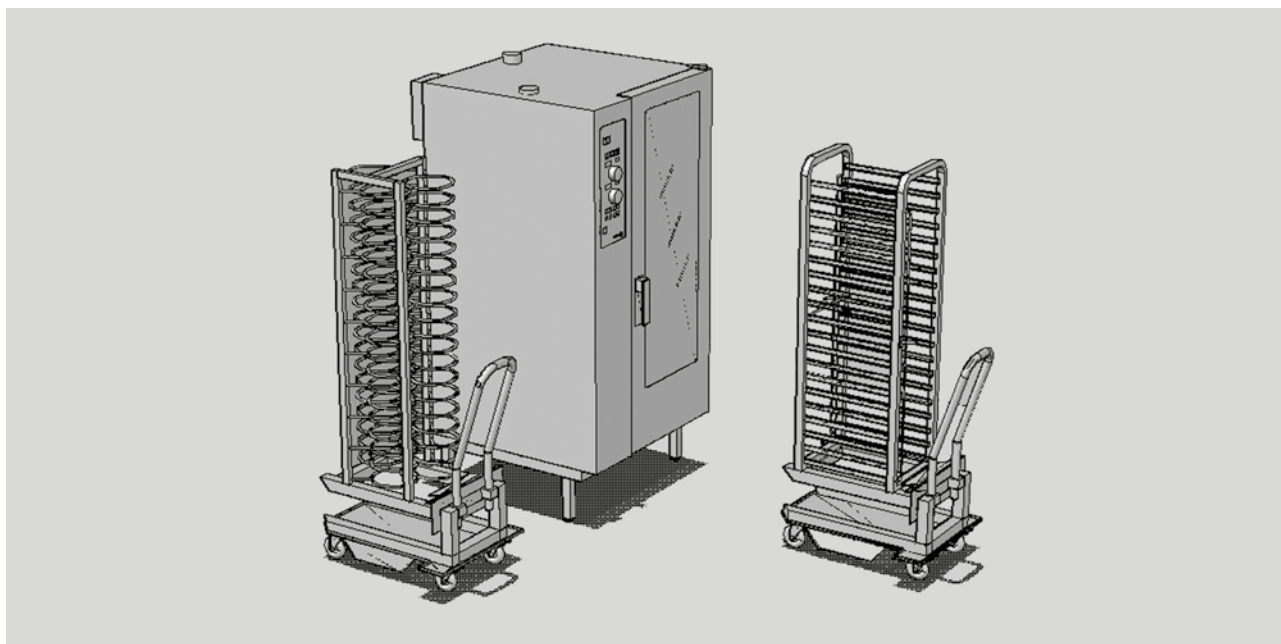

MODEL	CODE	DESCRIPTION	DIMENSIONS (mm)	€	
	CEB-201	19011551	TROLLEY WITH STRUCTURE (INCLUDED IN ADVANCE+ AND ADVANCE RANGE) For 20 GN-1/1 levels or 40 GN-1/2 levels.(Height between trays 63 mm)	560x769x1.750	-
	CEP-201	19013357	TROLLEY WITH STRUCTURE For 50 dishes Ø 31 cm.(Height between plates 75 mm)	560x769x1.750	-
	LTE-201	19011741	THERMICAL COVER For CEP-201 structure. Maintains food temperature 20'.	610x380x1.220	-
	R4-20	Consult	KIT OF CASTORS 4 castors, two with brake. For 201 and 202 models. (FACTORY MOUNTED)	-	-
	AP-20	19012270	KIT OF FASTENING ELEMENTS 2 pieces to fix the legs to the floor. For 201 and 202 models.	-	-
	GD-AD	19004504	SHOWER TAP. Outdoor use. (Only for ACE and ACG versions OF Concept RANGE).	-	-
	PRE-H201	19011979	PREHEAT KIT Kit of sealing elements to preheat oven without trolley.	-	-
	RH-201	19044716	LEVELLING RAMP for 201 trolleys.	-	-
	GP-201	19076154	Kit PASTRY GUIDES 17 levels for tray 60 x 40 cm (Height between trays 85 mm)	-	-

Accessories for 202 models

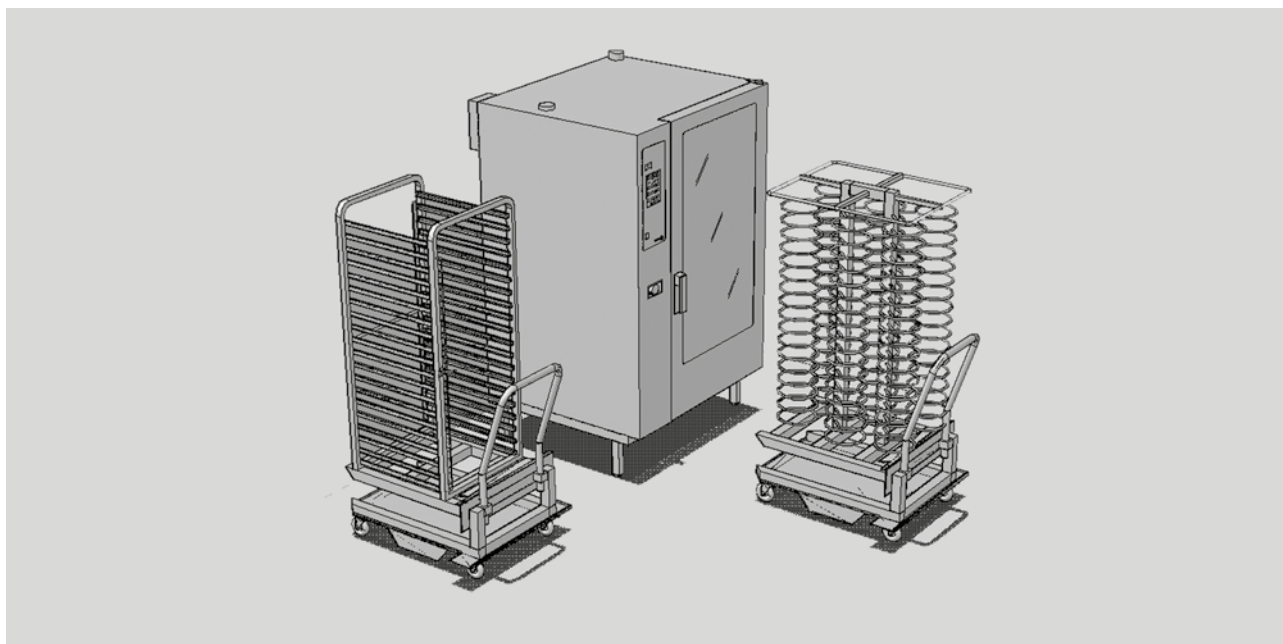











MODEL	CODE	DESCRIPTION	DIMENSIONS (mm)	€	
	CEB-202	19011550	TROLLEY WITH STRUCTURE (INCLUDED IN ADVANCE PLUS AND ADVANCE RANGES) For 20 GN-2/1 levels or 40 GN-1/1 levels. (Height between trays 63 mm)	764x915x1.810	-
	CEP-202	19011552	TROLLEY WITH STRUCTURE For CEP-202 structure. Maintains food temperature 20'. (Height between plates 75 mm)	764x915x1.810	-
	LTE-202	19011742	THERMICAL COVER For CEP-202 structure. Maintains food temperature 20'.	650x820x1.335	-
	R4-20	Consult	KIT OF CASTORS 4 castors, two with brake. For 201 and 202 models. (FACTORY MOUNTED)	-	-
	AP-20	19012270	KIT OF FASTENING ELEMENTS 2 pieces to fix the legs to the floor. For 201 and 202 models.	-	-
	GD-AD	19004504	SHOWER TAP. Outdoor use. (Only for ACE and ACG versions OF Concept RANGE).	-	-
	PRE-H202	19011980	PREHEAT KIT Kit of sealing elements to preheat oven without trolley.	-	-
	RH-202	19034438	LEVELLING RAMP for 202 trolleys.	-	-
	GP-202	19076575	Kit PASTRY GUIDES 34 levels for tray 60 x 40 cm (Height between trays 85 mm)	-	-

Gastronorm containers

Made of stainless steel AISI-304 1 mm thick. According to EN631 standard. 1/1 GN and 2/1 GN sizes.







Flat containers



MODEL	CODE	CAPACITY (L)	TYPE	DEPTH (mm)	DIMENSIONS (mm)	€
 GN-23-20 OPTIMA	19058658	1,70	GN-2/3	20	325x354x20	-
 GN-23-40 OPTIMA	19058659	3,20	GN-2/3	40	325x354x40	-
 GN-11-20	19001669	2,50	GN-1/1	20	325x530x20	-
 GN-11-40	19048493	5,50	GN-1/1	40	325x530x40	-
 GN-11-65	19048494	9,50	GN-1/1	65	325x530x65	-
 GN-11-100	19048495	14,00	GN-1/1	100	325x530x100	-
 GN-21-20	19001673	3,00	GN-2/1	20	650x530x20	-
 GN-21-40	19001674	10,50	GN-2/1	40	650x530x40	-
 GN-21-65	19001675	18,50	GN-2/1	65	650x530x65	-
 GN-21-100	19001672	28,00	GN-2/1	100	650x530x100	-

Perforated containers



MODEL	CODE	CAPACITY (L)	TYPE	DEPTH (mm)	DIMENSIONS (mm)	€
 GNP-23-20 OPTIMA	19058660	1,70	GN-2/3	20	325x354x20	-
 GNP-23-40 OPTIMA	19058661	3,20	GN-2/3	40	325x354x40	-
 GNP-11-40	19001677	5,50	GN-1/1	40	325x530x40	-
 GNP-11-65	19048496	9,50	GN-1/1	65	325x530x65	-
 GNP-11-100	19001676	14,00	GN-1/1	100	325x530x100	-
 GNP-21-40	19001680	10,50	GN-2/1	40	650x530x40	-
 GNP-21-65	19001681	18,50	GN-2/1	65	650x530x65	-
GNP-21-100	19001679	28,00	GN-2/1	100	650x530x100	-

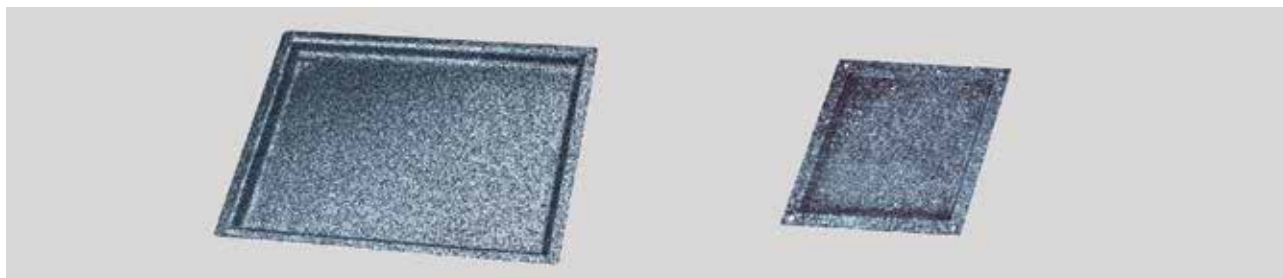

Granite containers



MODEL	CODE	CAPACITY (L)	TYPE	DEPTH (mm)	DIMENSIONS (mm)	€
TP23-20	OPTIMA 19058663	1,70	GN-2/3	20	325x354x20	-
TP23-40	OPTIMA 19059569	3,20	GN-2/3	40	325x354x40	-
TP11-20	19001978	2,50	GN-1/1	20	325x530x20	-
TP11-40	19001979	5,50	GN-1/1	40	325x530x40	-
TP11-65	19001980	9,50	GN-1/1	65	325x530x65	-
TP21-20	19001981	3,50	GN-2/1	20	650x530x20	-
TP21-40	19001982	10,50	GN-2/1	40	650x530x40	-
TP21-65	19001983	18,50	GN-2/1	65	650x530x65	-

Pastry containers



MODEL	CODE	FUNCTION COOKING	CHARACTERISTICS	DIMENSIONS (mm)	€
 BPA-23	OPTIMA 19058657	Pastry roasting	GN-2/3 - Lisa	325x354	-
 BPP-23	OPTIMA 19058656	Pastry cooking	GN-2/3 - Perforada	325x354	-
 BPA-11	19000313	Pastry roasting	GN-1/1 - Flat	325x530	-
 BPP-11	19000314	Pastry cooking	GN-1/1 - Perforated	325x530	-
 BB-11	19000279	Baguettes - Bread	GN-1/1 - 4 loaves	325x530	-

Eggs, omelette and crepes containers

Made of enamelled aluminum with non-stick coating.

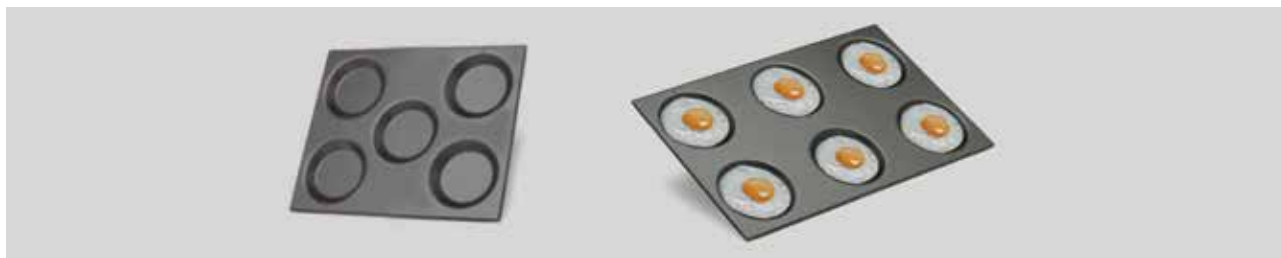

MODEL	CODE	FUNCTION COOKING	CHARACTERISTICS	DIMENSIONS (mm)	€
 MOLDE-23 OPTIMA	19059113	Eggs Omelettes Crepes	GN-2/3 5 holes x Ø 12,5 cm	325x354	-
 MOLDE-11	19001410	Eggs Omelettes Crepes	GN-1/1 6 holes x Ø 12,5 cm	325x530	-
 MOLDE-21	19001411	Eggs Omelettes Crepes	GN-2/1 12 holes x Ø 12,5 cm	650x530	-

Puddings and muffins container

Made of silicone.

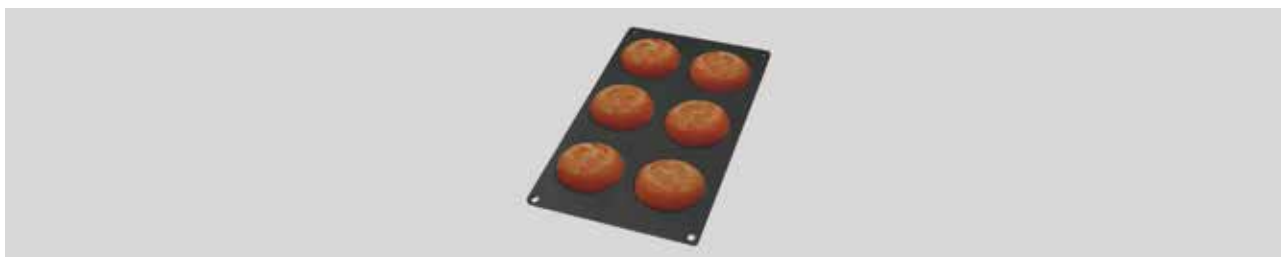



MODEL	CODE	FUNCTION COOKING	CHARACTERISTICS	DIMENSIONS (mm)	€ 3 UD.
 MUFFIN-6	19001459	Muffins Puddings	3 pieces SET MUFFIN-6 6 holes x (Ø 7 cm x H=4 cm)	325x175	-

Chips and fried container

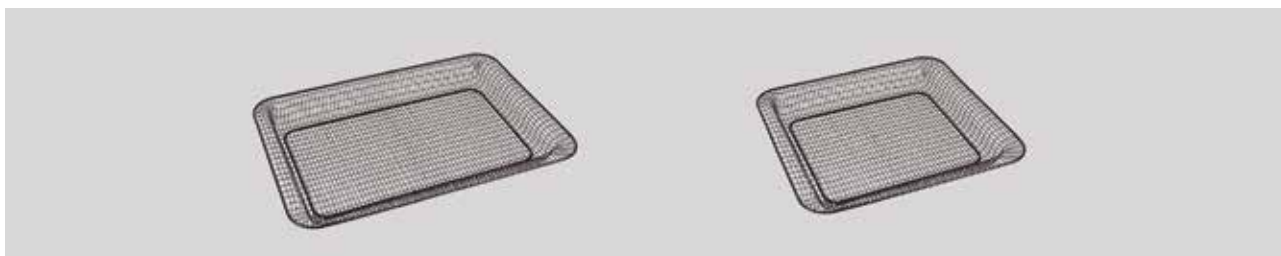
Made of stainless steel grid. Introduce the frozen product in the tray and placing it in the oven.





MODEL	CODE	FUNCTION COOKING	CHARACTERISTICS	DIMENSIONS (mm)	€
 FRI-23 OPTIMA	19058655	Chips Fried	GN-2/3	325x354	-
 FRI-11	19012415	Chips Fried	GN-1/1	325x530	-

Gastronorm grids

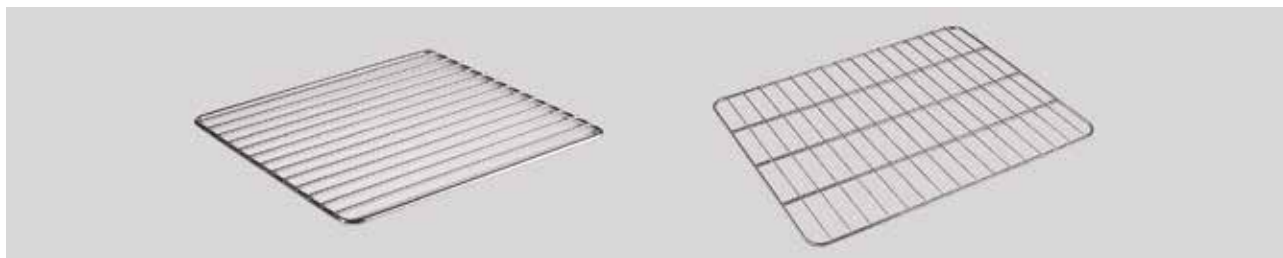
Made of AISI-304 wire.





MODEL	CODE	FUNCTION COOKING	CHARACTERISTICS	DIMENSIONS (mm)	€
 GRID GN-23	OPTIMA [®] 19058664	Support grill	GN-2/3	325x354	-
 GRID GN-11	19000999	Support grill	GN-1/1	325x530	-
 GRID GN-21	19001000	Support grill	GN-2/1	650x530	-

Chicken superspike and rib grid

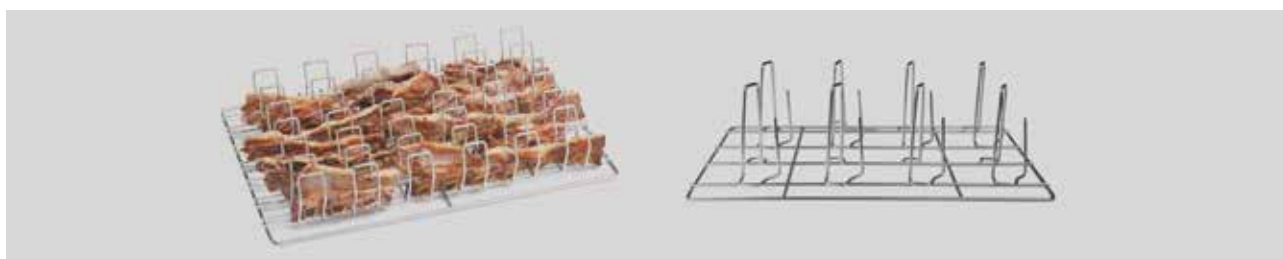
Made of AISI-304 wire.





MODEL	CODE	FUNCTION COOKING	CHARACTERISTICS	DIMENSIONS (mm)	€
 PO-GN-2/3	OPTIMA [®] 19068400	6 chickens	GN-2/3 It allows to place 6 chickens in vertical position	373x266	-
 PO-GN-1/1	19001496	8 chickens	GN-1/1 It allows to place 8 chickens in vertical position	325x530	-
 CO-GN-1/1	19000545	Chicken and ribs	GN-1/1 It allows to place food in vertical position	325x530	-

Griddle grids to roast or mark

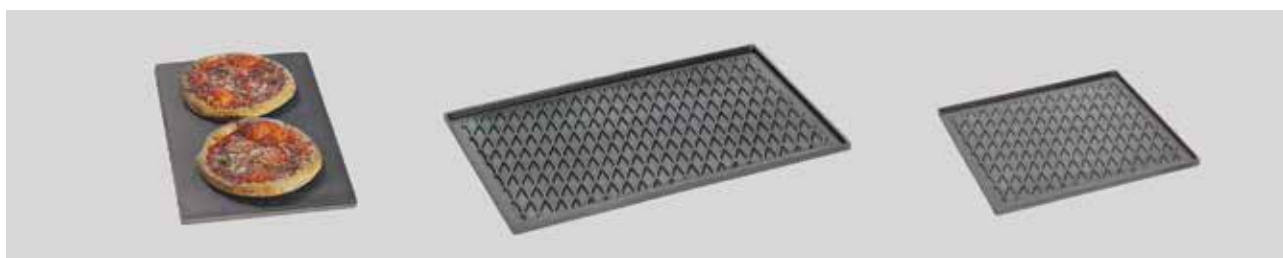
Made of enamelled aluminum with non-stick coating.



MODEL	CODE	FUNCTION COOKING	CHARACTERISTICS	DIMENSIONS (mm)	€
 MULTIGRILL 2/3	OPTIMA [®] 19058654	Grill pattern and roast	Two surfaces grid: roasting and grill pattern	325x354	-
 GRILL-1/1	19002844	Grill pattern	Ribbed grill	325x530	-
 MULTIGRILL 1/1	19001460	Grill pattern and roast	Two surfaces grid: roasting and grill pattern	325x530	-
FRY GRILL 2/3	OPTIMA [®] 19059568	Grill pattern	Ribbed grill	325x354	-
FRY GRILL 1/1	19076583	Grill pattern	Ribbed grill	325x530	-

Cooking accessories

Smoker



Smoking is a method which has been used for centuries to preserve food for longer or to give it a different taste, especially for meats, fish and vegetables.

By using the "smoker" accessory presented by Fagor Industrial, the combination oven is optimised and transformed into a smoker, saving space and time.

The user can apply typical smoked tastes and aromas as they cook in the oven by using chips of different types of wood, suitable for each cooking.

Once the smoker has been inserted into the oven, the time and temperature can be adjusted to regulate the intensity of the smoke.

MODEL	CODE	POWER W	VOLTAGE	HZ	DIMENSIONS (mm)	€
SMOKER	19059112	250	230 V 1N	50 / 60	95 x 268 x 54	-



Kit "sous vide" kit vacuum cooking

MODEL	CODE	DESCRIPTION	€
SOUS-AD	19032607	Special temperature control probe for vacuum cooking ("sous-vide"). The user chooses to connect to the control panel the probe with which they wish to work: that of the oven itself (multi-temperature) or the one for "sous-vide". Machines with a probe for vacuum cooking should be requested by indicating the following on the order: Machine code + SOUS-AD kit code. The oven will be dispatched from the factory ready prepared with the two probes and the connector on the control panel which allows one or the other to be connected depending on the type of cooking.	-

Assembly for ovens in column



General characteristics

- The kits for ovens in column are composed of a set of parts which allows the ovens to be positioned one above another.
- This type of assembly is carried out with 1/1 tray ovens, from any of the three electric ranges.
- The codes of the two ovens must be specified when placing the order, as well as the code of the kit of parts to carry out the assembly in column.
- Fagor Industrial supplies the column of ovens ready assembled and finished from the factory.
- Available only with electric models.
- Factory built-in only.

MODEL	CODE	DESCRIPTION	FOR OVENS:	€
STHH-23 OPTIMA	19059364	Kit elements for 2 stacking ovens, models:	0623 + 0623	-
2AD-66	19012191	Kit elements for 2 stacking ovens, models:	061 + 061	-
2AD-610	19012163	Kit elements for 2 stacking ovens, models:	061 + 101	-
2AD-66-I	19058005	Kit elements for 2 stacking ovens, left opening, models:	061-I + 061-I	-
2AD-610-I	19058004	Kit elements for 2 stacking ovens, left opening, models:	061-I + 101-I	-

Most common sets:

CODE	DESCRIPTION	€
19069633	Stacking Set (KIT STHH-23 + AE-0623+AE-0623)	-
19072563	Stacking Set (KIT 2AD-66 + APE-061+APE-061)	-
19073668	Stacking Set (KIT 2AD-66 + AE-061+AE-061)	-
19073669	Stacking Set (KIT 2AD-610 + APE-061 + APE-101)	-
19069336	Stacking Set (KIT 2AD-610 + AE-061 + AE-101)	-

Assembly for "Cook & chill" stacking



General characteristics

- Kit of elements to make a stacking system "Cook & Chill" with an oven and a blast chiller or freezer.
- In the order you must indicate these data:
 - Code for the oven.
 - Code for the blast chiller.
- Code for the assembly kit elements to carry out assembly in column.
- Fagor Industrial supplies the column of ovens ready assembled and finished from the factory.
- Factory built-in only.

MODEL	CODE	DESCRIPTION	FOR OVENS:	€
KIT STHA-23 OPTIMA	19066344	Kit elements for a COOK & CHILL	Oven 0623 + blast chiller & freezer 031	-
KIT C&C-061 ELEC	19020971	Kit elements for a COOK & CHILL	061 stacking with electric oven + blast chiller & freezer ATA-061	-
KIT C&C-061 GAS	19020972	Kit elements for a COOK & CHILL	061 stacking with gas oven + blast chiller & freezer ATA-061	-
CP-11-R (*)	19018752	(*) REGULABLE TROLLEY FOR STRUCTURE	To put 061 and 101 structures in the ovens placed over other supports at different height.	-

(*) : Obligatory use of GE-101 structure guides.

Most common sets:

CODE	DESCRIPTION	€
19073670	Stacking Set (KIT STHA-23 + AE-0623 + ATM-031 CD)	-
19073671	Stacking Set (KIT STHA-23 + ACE-0623 + ATM-031 CD)	-
19070753	Stacking Set (KIT C&C-061 + APE-061+ATA-061)	-

Transformation Kits

Kit drain pipe

MODEL	CODE	DESCRIPTION	€
 DES-CN	19012125	Necessary for proper drainage of the oven.	-

Kit baffle (gas ovens)

MODEL	CODE	DESCRIPTION	FOR GAS OVENS TYPE:	€
CEX-ADG-101	19012272	Set of elements that can be installed in a gas oven for connecting the outputs to an external extraction.	061 - 101	-
CEX-ADG-102	19012273		102	-
CEX-ADG-201	19012290		201	-
CEX-ADG-202	19012291		202	-

Kit fat - filter

MODEL	CODE	DESCRIPTION	€
Kit fat filter ADV-10	19020765	For Ovens 061 - 101 - 102	-
Kit fat filter ADV-20	19047250	For Ovens 201 - 202	-

Kits (various)

MODEL	CODE	DESCRIPTION	€
Sirena Kit	19053202	Audio and visual alarm for APE and APG ovens only.	-
Sicotronic Kit	19053217	Kit to connect the Sicotronic system for maximum consumption optimisation. Only for electric models.	-
Exhibition Control Panel Kit	19055976	Frontales de los 3 modelos de hornos (ACE, AE y APE) para expositores	-

Transformation to other voltages - ship voltage

MODEL	CODE	DESCRIPTION	FOR ELECTRIC OVENS TYPE:	€
400 V-AD Transformation kit for ships 400 V - 3 phase 50 / 60 Hz	19012546	Machines destined for ships, 400 V - 3 Phase, should be requested in the order indicating these data: Code for the standard appliance + Code for 400 V 3 Phase Kit. The machine will be shipped from factory prepared for this voltage.	061 - 101 - 102	-
400 V-AD Transformation kit for ships 400 V - 3 phase 50 / 60 Hz	19035948		201 - 202	-

Kit "neutral + earth ground" for gas ovens

MODEL	CODE	€
Kit Neutral + earth ground	19013247	-

Cleaning accessories

Detergents

To clean the internal cooking chamber.



MODEL	CODE	DESCRIPTION	VOLUME (KG)	€
AB BOOST	19084643	DETERGENT - Detergent Can	8,00	-
KOI PLUS	19084644	CLEANER - Cleaner Carafe	6,00	-





Commercial Refrigeration



Refrigerated cabinets

Gastronom.....	165
— Advance.....	165
— Monoblock Concept.....	167
— Concept.....	169
Snack.....	177
— Concept.....	177
Pastry.....	182
— Concept.....	182
Fish.....	183
— Concept.....	183

Special units or any variations from the standard model must be assembled at the factory at an additional charge over the standard model's price.

Please, contact Fagor Industrial for any other variation or option that is not included on this list.



European cold
for demanding
professionals.



Find out more!



Access the website







Sales brochure

The right cabinet for every need

A wide range of products to meet every market need. The Advance range represents Fagor's commitment to innovation and alignment with the most demanding levels of energy efficiency, obtaining Class A in the most popular models.

The Concept range is characterized by being the most economical line, but with a wide range unique in the market (GN, Snack, Pastry, Fish).

	2/1 GASTRONORM			SNACK	PASTRY	FISH
	GLOBE ADVANCE	GLOBE CONCEPT MONOBLOCK	GLOBE CONCEPT	GLOBE CONCEPT	GLOBE CONCEPT	GLOBE CONCEPT
DIMENSIONS (1 door)	693 x 856 x 2.106	653 x 796 x 1.996	653 x 842 x 2.040	693 x 726 x 2.067	760 X 742 X 2.006	760 X 742 X 2.006
Interior	EMBEDDED TRAY SLIDES	EMBEDDED TRAY SLIDES	EMBEDDED TRAY SLIDES	RACK HOLDERS AND GUIDES	RACK HOLDERS AND GUIDES	RACK HOLDERS AND GUIDES
CapaciTY (N° levels 1 door cabinet)	24 x GN 2/1	23 x GN 2/1	24 x GN 2/1	18 x Snack	17 x 600 x 400	7 drawers
ENERGY EFFICIENCY CLASS (1 door refrigerated cabinet)						-
Insulation	80 mm	60 mm	60 mm	50 mm	50 mm	50 mm
COOLANT +/-	R600a / R290	R600a / R290	R600a / R290	R600a / R290	R600a	R600a
CLIMATE CLASS (1 door)	5	4	4	4	4	4
AMBIENT TEMPERATURE (*)	43 °C	43 °C	43 °C	43 °C	43 °C	43 °C
COOLING SYSTEM	BUILT-IN	MONOBLOCK	BUILT-IN	BUILT-IN	BUILT-IN	BUILT-IN
LIGHTING	LED	LED	LED	LED	LED	LED
HACCP	YES	OPTIONAL	OPTIONAL	NO	NO	NO
ECO MODE	YES	YES	YES	NO	YES	YES
LOCK (large door)	YES	IN OPTION Standard with glass doors	IN OPTION Standard with glass doors	IN OPTION Standard with glass doors	OPTIONAL	OPTIONAL
PROTECTION GRADE	IPX5	IPX5	IPX5	IPX4	IPX5	IPX5
OPTIONAL DOOR OPENING PEDAL	YES	YES	YES	NO	YES	YES

(*) AMBIENT TEMPERATURE: Guaranteed operation at 43°C. Excluded display models with glass doors. For specific intensive usage please check with Fagor Commercial Manager.

ADVANCE | Gastronorm

ADVANCE is our line of technologically innovative cabinets that seeks to fulfil the expectations of the most demanding users.



UP TO 70%
ENERGY SAVING

General characteristics

- Constructed with AISI-304 stainless steel and also includes stainless steel back panel.
- High quality austenitic stainless steel inside and outside (included stainless steel back panel).
- 80 mm, 40 kg/m³ injected polyurethane insulation.
- Embedded inner tray slides. Storage trays at 24 different levels 55 mm from each other.
- Forced draught cooling system.
- Copper piping and aluminium flaps evaporator.
- HACCP system that keeps running logs.
- Digital display for electronic and digital control of temperature and defrosting.
- Acoustic and visual alarm connected to three sensors at strategic spots.

- They provide a total control and block the compressor in case of dirt or failure.
- Opened door delay alarm.
- Self-closing and stay open doors. When opened less than 90° they close by themselves. When opened more than 135° they stay open.
- Built-in drainage to get rid of waste liquids inside the unit.
- Removable plastic covered steel grid shelves (GN 2/1) for easy cleaning. Equipment: 3 shelves per large door.
- Embedded bottom and curved panels inside for easy cleaning and maintenance.
- Height adjustable stainless steel legs.
- Working temperature: from -2 °C to +8 °C (refrigerators) and from -18 °C to -22 °C (freezers).

- Negative cabinets:
 - Thermostatic expansion valve that ensures optimal management of the cold circuit.
 - Hot gas defrost.
 - Ambient temperature: 43 °C (*)
 - Inner LED lights with power switch (now also in freezing units).
 - Locks included as a standard in all doors.

Options:

- Castor kit (factory assembly).
- Reversible door.
- Door opening pedal (factory assembly).
- Heated door frame to avoid condensation in high humidity environments.

Refrigerated Cabinets



EAAFP-801

Freezer Cabinets



EAAFN-1602

Refrigerated display cabinets



EAAEP-801/ EAAEP-1602

VISIBILITY:
Vertical LED light for greater visibility.

MODEL	COOLANT	HZ.	CODE	CLIMATIC CLASS	N° DOORS	ENERGY EFFICIENCY CLASS	GROSS CAPACITY (L)	ANNUAL ENERGY CONSUMPTION	ELECTRIC POWER (W)	DIMENSIONS (mm)	€
Refrigerated cabinets											
EAAFP-801	R600a	50	19081139	5	1	A	610	337	158	693x856x2.106	-
	R290	60	19081140			-		-	250		
EAAFP-1602	R600a	50	19081141	5	2	B	1.332	833	192	1.358x856x2.106	-
	R290	60	19081142			-		-	316		
Freezer cabinets											
EAAFN-801	R290	50	19081143	5	1	D	610	2.754	471	693x856x2.106	-
		60	19081144			-		496			
EAAFN-1602	R290	50	19081145	4	2	D	1.332	4.599	749	1.358x856x2.106	-
		60	19081147			-		831			
EAAFN-1602	R290	50	19059043	5	2	D	1.332	4.258	750	1.358x856x2.106	-
Refrigerated display cabinets											
EAAEP-801	R600a	50	19081148	4	1	-	610	337	158	693x856x2.106	-
EAAEP-1602	R600a	50	19081149	4	2	-	1.332	833	192	1.358x856x2.106	-

(*) AMBIENT TEMPERATURE: Guaranteed operation at 43°C. Excluded display models with glass doors. For specific intensive usage please check with Fagor Commercial Manager.

CONCEPT | Monoblock

Our CONCEPT Monoblock cabinets present a wide range of products in its Gastronorm version that are characterised by the optimisation of their storage capacity.



General characteristics

- Constructed with AISI-304 stainless steel.
- High quality austenitic stainless steel inside and outside (except for galvanised back panel).
- 60 mm, 40 kg/m³ injected polyurethane insulation.
- Embedded inner tray slides. Storage trays at 23 different levels 55 mm from each other.
- Forced draught system with cooling unit outside the room and monoblock system to optimise storage capacity.
- Copper piping and aluminium flaps evaporator.
- Digital display for electronic and digital control of temperature and defrosting.
- Opened door delay alarm.
- Self-closing and stay open doors. When opened less than 90° they close by themselves. When opened more than 135° they stay open.
- Built-in drainage to get rid of waste liquids inside the unit.
- Embedded bottom and curved panels inside for easy cleaning and maintenance.
- Removable plastic covered steel grid shelves (GN 2/1) for easy cleaning. Equipment: 3 shelves per large door.
- Height adjustable stainless steel legs.
- Working temperature: from -2 °C to +8 °C (refrigerators) and from -18 °C to -22 °C (freezers).
- Ambient temperature: 43 °C (*)
- Climatic class 4.
- Inner LED lights with power switch (now also in freezing units).

Options:

- Lock (large door models)
- Standard with glass doors.
- Castor kit (factory assembly).
- Reversible door.
- Heated door frame to avoid condensation in high humidity environments.
- HACCP.
- Door opening pedal (factory assembly).
- Stainless steel back panel.

Refrigerated cabinets



EMAFP-1602

Freezer cabinets



EMAFN-801

Refrigerated display cabinets



EMAEP-801

VISIBILITY:
Vertical LED light for greater visibility.

Mixed refrigeration cabinet and freezer



EMAF-1602 MIX

DUAL TEMPERATURE:
Models with two storage temperatures and independent refrigeration systems.

MODEL	COOLANT	HZ.	CODE	N° DOORS	ENERGY EFFICIENCY CLASS	GROSS CAPACITY (L)	ANNUAL ENERGY CONSUMPTION (KW-H)	ELECTRIC POWER (W)	DIMENSIONS (mm)	€
Refrigerated Cabinets										
EMAFP-801	R600a	50	19037603	1	B	572	423	143	653x796x1.996	-
EMAFP-802	R600a	50	19037604	2	B	572	423	143	653x796x1.996	-
EMAFP-1602	R600a	50	19037606	2	C	1.144	756	184	1.318x796x1.996	-
EMAFP-1603	R600a	50	19037607	3	C	1.144	756	184	1.318x796x1.996	-
EMAFP-1604	R600a	50	19037608	4	C	1.144	756	184	1.318x796x1.996	-
Freezer cabinets										
EMAFN-801	R290	50	19037691	1	D	572	2.040	678	653x796x1.996	-
		60	19074215	-	-		719			
EMAFN-802	R290	50	19037692	2	D	572	2.040	684	653x796x1.996	-
		60	19074216	-	-		725			
EMAFN-1602	R290	50	19037695	2	E	1.144	4.855	942	1.318x796x1.996	-
		60	19073516	-	-		998			
EMAFN-1603	R290	50	19037696	3	E	1.144	4.855	948	1.318x796x1.996	-
		60	19074226	-	-		1.004			
EMAFN-1604	R290	50	19037697	4	E	1.144	4.855	954	1.318x796x1.996	-
		60	19074227	-	-		1.010			
Refrigerated display cabinets										
EMAEP-801	R600a	50	19037605	1	-	572	-	146	653x796x1.996	-
EMAEP-1602	R600a	50	19037610	2	-	1.144	-	190	1.318x796x1.996	-
Mixed refrigeration and freezer cabinet										
EMAF-1602 MIX	R600a+R290	50	19038300	2	-	1.144	-	821	1.318x796x1.996	-
		60	19074231	-	-			972		

(*) AMBIENT TEMPERATURE: Guaranteed operation at 43°C. Excluded display models with glass doors. For specific intensive usage please check with Fagor Commercial Manager.

CONCEPT | Gastronorm

Our CONCEPT cabinets in their Gastronorm version offer a wide and diverse range of quality products to suit every business's needs and requirements.



UP TO 60%
ENERGY SAVING
WITH HC GASES

General characteristics

- Constructed with AISI-304 stainless steel.
- High quality austenitic stainless steel inside and outside (except for galvanised back panel).
- 60 mm, 40 kg/m³ injected polyurethane insulation.
- Embedded inner tray slides. Storage trays at 24 different levels 55 mm from each other.
- Forced draught cooling system with hermetically sealed compressor.
- Copper piping and aluminium flaps evaporator.
- Digital display for electronic and digital control of temperature and defrosting.
- Opened door delay alarm.
- Self-closing and stay open doors. When opened less than 90° they close by themselves. When opened more than 135° they stay open.
- Built-in drainage to get rid of waste liquids inside the unit.
- Embedded bottom and curved panels inside for easy cleaning and maintenance.
- Removable plastic covered steel grid shelves (GN 2/1) for easy cleaning. Equipment: 3 shelves per large door.
- Height adjustable stainless steel legs.
- Working temperature: from -2 °C to +8 °C (refrigerators) and from -18 °C to -22 °C (freezers).
- Negative cabinets: hot gas defrost.
- Ambient temperature: 43 °C (*)
- Climatic class 4.
- Inner LED lights with power switch (in refrigerated cabinets and now also in freezing units).

Options:

- Lock (large door models)
Standard with glass doors.
- Castor kit (factory assembly).
- Reversible door.
- Heated door frame to avoid condensation in high humidity environments.
- Door opening pedal (factory assembly).
- HACCP.
- Stainless steel back panel.

(*) AMBIENT TEMPERATURE:

Guaranteed operation at 43°C. Excluded display models with glass doors. For specific intensive usage please check with Fagor Commercial Manager.

Refrigerated cabinets



EAFP-1602

EAFP-802

MODEL	COOLANT	HZ.	CODE	N° DOORS	ENERGY EFFICIENCY CLASS	GROSS	INSULATION THICKNESS (mm)	EMBEDDED GUIDES	ANNUAL ENERGY CONSUMPTION (KWH)	ELECTRIC POWER (W)	DIMENSIONS (mm)	€
REFRIGERATED CABINETS												
EAFP-801	R600a	50	19037764	1	C	610	60	+	548	183	653x842x2.040	-
	R290	60	19073313		-				-	275		
EAFP-802	R600a	50	19037772	2	C	610	60	+	548	183	653x842x2.040	-
	R290	60	19074232		-				-	275		
EAFP-1602	R600a	50	19037832	2	C	1.332	60	+	913	206	1.318x842x2.040	-
		60	19073269		-				-	223		
EAFP-1603	R600a	50	19037834	3	C	1.332	60	+	913	206	1.318x842x2.040	-
		60	19074233		-				-	223		
EAFP-1604	R600a	50	19037835	4	C	1.332	60	+	913	206	1.318x842x2.040	-
		60	19074234		-				-	223		

Freezer cabinets



EAFN-1602



EAFN-801



MODEL	COOLANT	HZ.	CODE	N° DOORS	ENERGY EFFICIENCY CLASS	GROSS	INSULATION THICKNESS (mm)	EMBEDDED GUIDES	ANNUAL ENERGY CONSUMPTION (KWH)	ELECTRIC POWER (W)	DIMENSIONS (mm)	€
FREEZER CABINETS												
EAFN-801	R290	50	19081150	1	D	610	60	+	2.714	471	653x842x2.040	-
		60	19081151						-	496		
EAFN-802	R290	50	19081152	2	D	610	60	+	2.714	477	653x842x2.040	-
		60	19081153						-	502		
EAFN-1602	R290	50	19081154	2	E	1.332	60	+	4.793	749	1.318x842x2.040	-
		60	19081155						-	831		
EAFN-1603	R290	50	19081156	3	E	1.332	60	+	4.793	755	1.318x842x2.040	-
		60	19081157						-	837		
EAFN-1604	R290	50	19081158	4	E	1.332	60	+	4.793	760	1.318x842x2.040	-
		60	19081159						-	842		

Refrigerated display cabinets



EAEP-1602

VISIBILITY:
Vertical LED light which optimises the visibility of the products on display

MODEL	GAS	HZ.	CODE	N° DOORS	GROSS CAPACITY (L)	INSULATION THICKNESS (mm)	EMBEDDED TRAY SLIDES	ELECTRIC POWER (W)	DIMENSIONS (mm)	€
REFRIGERATED DISPLAY CABINETS										
EAEP-801	R600a	50	19037812	1	610	60	+	186	653x842x2.040	-
	R290	60	19074239					278		
EAEP-802	R600a	50	19037813	2	610	60	+	185	653x842x2.040	-
	R290	60	19074240					277		
EAEP-1602	R600a	50	19037843	2	1.332	60	+	212	1.318x842x2.040	-
		60	19074241					229		

Cabinets for refrigeration and freezing

Mixed cabinet Refrigeration and freezing



EAF-1602 MIX

Refrigeration cabinets with freezing compartment



EAF-802 C



EAF-1603 C

Mixed

Two independent modules with their respective refrigeration units and electronic controls.

Refrigeration module:

- Forced draught refrigeration
- Operational temperature: -2 °C, +8 °C /





Freezer module:

- Forced draught evaporator
- Operational temperature: -18 °C, -22 °C.

Freezer compartment (❄️):

Equipment: (3 drawers in sanitary PVC Independent hermetic compressor with ventilated condenser.

Evaporator with copper pipe and aluminium cooling fins. Environmentally-friendly refrigerant R290. Forced draught refrigeration / Automatic evaporation of frost water) / Operational temperature: -18 °C, -22 °C.

MODEL	COOLANT	HZ.	CODE	N° DOORS	GROSS CAPACITY (L)	INSULATION THICKNESS (mm)	ELECTRIC POWER (W)	DIMENSIONS (mm)	€
MIXED REFRIGERATION AND FREEZER CABINET									
 EAF-1602 MIX	R600a+R290	50	19038287	1+1	1.220	60	883	1.318x842x2.040	-
		60	19074243				1.016		
REFRIGERATION CABINETS WITH FREEZING COMPARTMENT									
 EAF-802 C	R290	50	19038516	1+❄️	596	60	1.091	693x826x2.008	-
		60	19074244				1.178		
 EAF-1603 C	R600a+R290	50	19038521	2+❄️	1.301	60	1.008	1.388x826x2.008	-
		60	19074245				1.067		
 EAF-1604 C	R600a+R290	50	19038522	3+❄️	1.301	60	1.008	1.388x826x2.008	-
		60	19074246				1.067		

Refrigeration cabinets with fish compartment





EAFP-802-P



EAFP-1603 P

Fish compartment (🐟):

Equipment: 3 drawers in sanitary PVC. Independent hermetic compressor with ventilated condenser. Copper tube evaporator and aluminum fins. R290 ecological refrigerant. Forced draft cooling. Automatic evaporation of the defrost water.
Operational temperature: -18 °C, -22 °C.

MODEL	COOLANT	HZ.	CODE	N° DOORS	ENERGY EFFICIENCY CLASS	GROSS CAPACITY (L)	INSULATION THICKNESS (mm)	EMBEDDED GUIDES	ANNUAL ENERGY CONSUMPTION (KW-H)	ELECTRIC POWER (W)	DIMENSIONS (mm)	€
REFRIGERATED CABINETS WITH FISH COMPARTMENT												
 EAFP-802 P	R290	50	19038518	1+ 🐟	D	596	60	+	679	954	693x826x2.008	-
 EAFP-1603 P	R600a+R290	50	19038531	2+ 🐟	D	1.301	60	+	906	852	1.388x826x2.008	-
 EAFP-1604 P	R600a+R290	50	19038532	3+ 🐟	D	1.301	60	+	906	852	1.388x826x2.008	-

Dual temperature cabinets







EAFP-1602/2



EAFP-802/2

TWO TEMPERATURES
2 separate compartments with independent refrigeration units, systems and thermostats.

MODEL	COOLANT	HZ.	CODE	N° DOORS	ENERGY EFFICIENCY CLASS	GROSS CAPACITY (L)	INSULATION THICKNESS (mm)	EMBEDDED GUIDES	ANNUAL ENERGY CONSUMPTION (KW·H)	ELECTRIC POWER (W)	DIMENSIONS (mm)	€
DUAL TEMPERATURE CABINETS												
 EAFP-802/2	R290	50	19042469	1+1	D	596	50	+	679	616	693x826x2.008	-
 EAFP-1602/2	R600a	50	19042473	1+1	D	1.301	50	+	905	367	1.388x826x2.008	-
 EAFP-1603/2	R600a	50	19042470	2+1	D	1.301	50	+	905	367	1.388x826x2.008	-
 EAFP-1604/2	R600a	50	19042471	3+1	D	1.301	50	+	905	367	1.388x826x2.008	-

CONCEPT | 1/1 Gastronorm

Our CONCEPT cabinets in their 1/1 Gastronorm version offer a new solution for storage in small spaces.



General characteristics

- Constructed with AISI-304 stainless steel.
- High quality austenitic stainless steel inside and outside (except for galvanised back panel).
- 60 mm, 40 kg/m³ injected polyurethane insulation.
- Storage trays at 18 different levels 70 mm from each other.
- Forced draught cooling system with hermetically sealed compressor.
- Copper piping and aluminium flaps evaporator.
- Digital display for electronic and digital control of temperature and defrosting.
- Opened door delay alarm.
- Self-closing and stay open doors. When opened less than 90° they close by themselves. When opened more than 135° they stay open.
- Built-in drainage to get rid of waste liquids inside the unit.
- Embedded bottom and curved panels inside for easy cleaning and maintenance.
- Removable plastic covered steel grid shelves (GN 1/1) for easy cleaning. Equipment: 3 shelves per large door.
- Height adjustable stainless steel legs.
- Working temperature: from -2 °C to +8 °C (refrigerators) and from -18 °C to -22 °C (freezers).
- Ambient temperature: 43 °C (*)
- Climatic class 4.
- Inner LED lights with power switch (in refrigerated cabinets and now also in freezing units).

Options:

- Lock.
- Standard with glass doors.
- Reversible door.
- Heated door frame to avoid condensation in high humidity environments.
- Stainless steel back panel.

MODEL	COOLANT	HZ.	CODE	N° DOORS	ENERGY EFFICIENCY CLASS	GROSS CAPACITY (L)	INSULATION THICKNESS (mm)	ANNUAL ENERGY CONSUMPTION (KW-H)	ELECTRIC POWER (W)	DIMENSIONS (mm)	€
REFRIGERATED CABINET											
EAFP-401	R600a	50	19058720	1	D	305	60	726	205	488x703x2.008	-
		60	19074254		-			297			
DISPLAY REFRIGERATED CABINET											
EAEP-401	R600a	50	19059011	1	-	305	60	-	208	488x703x2.008	-
		60	19074255		-			-			
FREEZER CABINET											
EAFN-401	R290	50	19058721	1	E	305	60	2.197	719	488x703x2.008	-
		60	19074256		-			760			

(*) AMBIENT TEMPERATURE: Guaranteed operation at 43°C. Excluded display models with glass doors. For specific intensive usage please check with Fagor Commercial Manager.

CONCEPT | Snack

Adaptable to every single space and need, we provide Snack size CONCEPT cabinets, with similar features and identical quality standards.



UP TO 50%
ENERGY SAVING
WITH HC GASES

General characteristics

- Constructed with AISI-304 stainless steel.
- High quality austenitic stainless steel inside and outside (except for galvanised back panel).
- 50 mm, 40 kg/m³ injected polyurethane insulation.
- Removable and height adjustable plastic covered steel shelves (17 Snack size levels) for easy cleaning. Equipment: 3 shelves per large door.
- Forced draught cooling system.
- Copper piping and aluminium flaps evaporator.
- Digital display for electronic and digital control of temperature and defrosting.
- Opened door delay alarm.
- Self-closing and stay open doors. When opened less than 90° they close by themselves. When opened more than 135° they stay open.
- Built-in drainage to get rid of waste liquids inside the unit.
- Embedded bottom and curved panels inside for easy cleaning and maintenance.
- Height adjustable stainless steel legs.
- Working temperature: from -2 °C to +8 °C (refrigerators) and from -18 °C to -22 °C (freezers).
- Ambient temperature: 43 °C (*)
- Climatic class 4.
- Inner LED lights with power switch (in refrigerated display cabinets and now also in freezing units).

Options:

- Lock (large door models). Standard with glass doors.
- Castor kit (factory assembly).
- Reversible door (1 large door models).
- Meat bar.
- Tropicalised units: Heated door frame to avoid condensation in high humidity environments.
- Stainless steel back panel.

(*) AMBIENT TEMPERATURE: Guaranteed operation at 43°C. Excluded display models with glass doors. For specific intensive usage please check with Fagor Commercial Manager.

Refrigerated cabinets

Refrigerated cabinets

Refrigerated display cabinets



EAFP-701



EAFP-1402



EAEP-701

VISIBILITY:

Vertical LED light which optimises the visibility of the products on display

	MODEL	GAS	HZ.	CODE	N° DOORS	ENERGY EFFICIENCY CLASS	GROSS CAPACITY (L)	ANNUAL ENERGY CONSUMPTION (KW-H)	ELECTRIC POWER (W)	DIMENSIONS (mm)	€
REFRIGERATED CABINETS											
	EAFP-701	R600a	50	19037070	1	C	506	548	183	693x726x2.067	-
			60	19074257		-		275			
	EAFP-702	R600a	50	19037071	2	C	506	548	183	693x726x2.067	-
			60	19074258		-		275			
	EAFP-1402	R600a	50	19037139	2	C	1.109	975	206	1.388x726x2.067	-
			60	19074259		-		223			
	EAFP-1403	R600a	50	19037140	3	C	1.109	975	206	1.388x726x2.067	-
			60	19074260		-		223			
	EAFP-1404	R600a	50	19037141	4	C	1.109	975	206	1.388x726x2.067	-
			60	19074261		-		223			
REFRIGERATED DISPLAY CABINETS											
	EAEP-701	R600a	50	19037072	1	-	506	-	186	693x726x2.067	-
			60	19074267		-		278			
	EAEP-1402	R600a	50	19037143	2	-	1.109	-	212	1.388x726x2.067	-
			60	19074268		-		229			

Freezer cabinets



EAFN-1404



EAFN-702

	MODEL	GAS	HZ.	CODE	N° DOORS	ENERGY EFFICIENCY CLASS	GROSS CAPACITY (L)	ANNUAL ENERGY CONSUMPTION (KW-H)	ELECTRIC POWER (W)	DIMENSIONS (mm)	€
FREEZER CABINETS											
	EAFN-701	R290	50	19037702	1	D	506	2.179	700	693x726x2.067	-
			60	19074262		-		741			
	EAFN-702	R290	50	19037703	2	D	506	2.179	706	693x726x2.067	-
			60	19074263		-		747			
	EAFN-1402	R290	50	19037712	2	E	1.109	4.855	1.251	1.388x726x2.067	-
			60	19074264		-		1.307			
	EAFN-1403	R290	50	19037713	3	E	1.109	4.855	1.257	1.388x726x2.067	-
			60	19074265		-		1.313			
	EAFN-1404	R290	50	19037714	4	E	1.109	4.855	1.263	1.388x726x2.067	-
			60	19074266		-		1.319			

Cabinets for refrigeration and freezing

Refrigeration and freezer mixed cabinet



EAJ-1402 MIX

Refrigeration cabinets with freezing compartment



EAJ-702 C

MIXED

Two independent modules with their respective refrigeration units and electronic controls.

Refrigeration module:





- Refrigerant R600a, CFC-free. Forced draught refrigeration
- Operational temperature: -2 °C, +8 °C (ambient 38 °C)

Freezer module:

- Refrigerant R290, CFC-free. Forced draught evaporator
- Operational temperature: -18 °C, -22 °C.

FREEZER COMPARTMENT (❄️):

Equipment: 3 drawers in sanitary PVC. Independent hermetic compressor with ventilated condenser. Copper tube evaporator and aluminum fins. Ecological refrigerant R290 without CFC. Forced draft cooling. Automatic evaporation of the defrost water. Operational temperature: -18 °C, -22 °C.

MODEL	COOLANT	HZ.	CODE	N° DOORS	GROSS CAPACITY (L)	ELECTRIC POWER (W)	DIMENSIONS (mm)	€
REFRIGERATION AND FREEZER MIXED CABINET								
	EAJ-1402 MIX	R600a+R290 R290	50	19037927	1+1	1.012	1.388x726x2.067	-
			60	19074269				
REFRIGERATION CABINETS WITH FREEZING COMPARTMENT								
	EAJ-702 C	R290	50	19038534	1+❄️	506	693x726x2.067	-
			60	19074270				
	EAJ-1403 C	R600a+R290	50	19038536	2+❄️	1.109	1.388x726x2.067	-
			60	19074271				
	EAJ-1404 C	R600a+R290	50	19038537	3+❄️	1.109	1.388x726x2.067	-
			60	19074273				



Refrigeration cabinets with fish compartment



EAF-1403 P

FISH COMPARTMENT (🐟):

Equipment: 3 drawers in sanitary PVC with perforated stainless steel bottom. Independent hermetic compressor with ventilated condenser. Ecological refrigerant R290 without CFC. Cold plate evaporator. Drain in evaporator tray. Drain pipe of the enclosure to connect to an external drain.
Operational temperature: -4 °C, -1 °C. / Volume: 300 litres.

MODEL	COOLANT	HZ.	CODE	NO. OF DOOR	ENERGY EFFICIENCY CLASS	GROSS CAPACITY (L)	ANNUAL ENERGY CONSUMPTION (KW-H)	ELECTRIC POWER (W)	DIMENSIONS (mm)	€
REFRIGERATION CABINETS WITH FISH COMPARTMENT										
 EAF-702 P	R290	50	19038535	1+ 🐟	D	506	679	874	693x726x2.067	-
 EAF-1403 P	R600a+R290	50	19038538	2+ 🐟	D	1.109	906	852	1.388x726x2.067	-
 EAF-1404 P	R600a+R290	50	19038539	3+ 🐟	D	1.109	906	852	1.388x726x2.067	-

CONCEPT | Pastry

We manufacture special cabinets for pastry with a single door and 17 levels for 600 x 400 mm trays.



General characteristics

- Constructed with AISI-304 stainless steel.
- High quality austenitic stainless steel inside and outside (except for galvanised back panel).
- 50 mm, 40 kg/m³ injected polyurethane insulation.
- Stainless steel inside with robust tray slides for standard 600 x 400 mm baking trays (up to 17 levels).
- The standard equipment includes 3 plastic covered steel baking trays.
- Copper piping and aluminium flaps evaporator with rust free protective coating.
- Digital display for electronic and digital control of temperature and defrosting.
- Opened door delay alarm.
- Self-closing and stay open doors. When opened less than 90° they close by themselves. When opened more than 135° they stay open.
- Built-in drainage to get rid of waste liquids inside the unit.
- Embedded bottom and curved panels inside for easy cleaning and maintenance.
- LED lighting system.
- Removable plastic covered steel grid shelves for easy cleaning. Equipment: 3 shelves per large door.
- Height adjustable stainless steel legs.
- Forced draught cooling system to keep the working temperature between +2 °C and +8 °C.
- Ambient temperature: 43 °C (*)
- Climatic class 4.

MODEL	COOLANT	HZ.	CODE	N° DOORS	ENERGY EFFICIENCY CLASS	GROSS CAPACITY (L)	ANNUAL ENERGY CONSUMPTION (KWH)	ELECTRIC POWER (W)	DIMENSIONS (mm)	€
EAPP-701	R290	50	19037778	1	E	574	986	182	760x742x2.006	-

(*) AMBIENT TEMPERATURE: Guaranteed operation at 43°C. For specific intensive usage please check with Fagor Commercial Manager.

Pastry Accessories *

DESCRIPTION	CODE
Epoxy pastry grid (600 x 400)	12034886
Stainless steel pastry grid (600 x 400)	19001001
Stainless steel pastry tray (600 x 400)	19010201
Pastry grid slide (485mm - 1 piece)	12036689

* Check prices at the list of accessories and spare parts.

CONCEPT | Fish

As a complement to our CONCEPT range we provide a compartment for fish. The compartment is fitted with special drawers and is programmed to work at the most suitable temperature to keep fish fresh for a longer time.



General characteristics

- Constructed with AISI-304 stainless steel.
- High quality austenitic stainless steel inside and outside (except for galvanised back panel).
- 50 mm, 40 kg/m³ injected polyurethane insulation.
- 7 large capacity drawers for fish made of sanitary PVC and fitted with a perforated steel double bottom.
- Copper piping and aluminium flaps evaporator with rust free protective coating.
- Digital display for electronic and digital control of temperature and defrosting.
- Opened door delay alarm.
- Self-closing and stay open doors. When opened less than 90° they close by themselves. When opened more than 135° they stay open.
- Back pipe to collect the waste from each drawer into a general drain.
- Embedded bottom and curved panels inside for easy cleaning and maintenance.
- LED lighting system.
- Height adjustable stainless steel legs.
- Forced draught cooling system to keep the working temperature between -4 °C and -1 °C.
- Ambient temperature: 43 °C (*)
- Climatic class 4.

MODEL	COOLANT	HZ.	CODE	N° DOORS	GROSS CAPACITY (L)	ELECTRIC POWER (W)	DIMENSIONS (mm)	€
EAP-701	R290	50	19037780	1	574	549	760x742x2.006	-

(*) AMBIENT TEMPERATURE: Guaranteed operation at 43°C. For specific intensive usage please check with Fagor Commercial Manager.

Fish Accessories *

* Check prices at the list of accessories and spare parts.

DESCRIPTION	CODE
Grey drawer with handles (600x400x120)	12033925

Available options and price increment per model

MODEL	STAINLESS STEEL BACK PANEL	LOCK (LARGE DOOR)	HACCP	WHEELS KIT (FACTORY ASSEMBLY)	HEATED DOR FRAME	REVERSED OPENING	OPENING PEDAL
	RI (€)	CR (€)	(€)	R (€)	T (€)	AC (€)	PA (€)
Advance Gastronorm							
EAAFP-801	Std	Std	Std	0	0	0	0
EAAFP-1602	Std	Std	Std	0	0	-	0
EAAFN-801	Std	Std	Std	0	Std	0	0
EAAFN-1602	Std	Std	Std	0	Std	-	0
EAAEP-801	Std	Std	Std	0	0	0	0
EAAEP-1602	Std	Std	Std	0	0	-	0
Concept Monoblock							
EMAFP-801	0	0	0	0	0	0	0
EMAFP-802	0	-	0	0	0	-	-
EMAFP-1602	0	0	0	0	0	-	0
EMAFP-1603	0	-	0	0	0	-	-
EMAFP-1604	0	-	0	0	0	-	-
EMAFN-801	0	0	0	0	Std	0	0
EMAFN-802	0	-	0	0	Std	-	-
EMAFN-1602	0	0	0	0	Std	-	0
EMAFN-1603	0	-	0	0	Std	-	-
EMAFN-1604	0	-	0	0	Std	-	-
EMAEP-801	0	Std	0	0	0	0	0
EMAEP-1602	0	Std	0	0	0	-	0
EMAF-1602 MIX	0	0	0	0	0	-	0
Concept Gastronorm							
EAFP-801	0	0	0	0	0	0	0
EAFP-802	0	-	0	0	0	-	-
EAFP-1602	0	0	0	0	0	-	0
EAFP-1603	0	-	0	0	0	-	-
EAFP-1604	0	-	0	0	0	-	-
EAFN-801	0	0	0	0	Std	0	0
EAFN-802	0	-	0	0	Std	-	-
EAFN-1602	0	0	0	0	Std	-	0
EAFN-1603	0	-	0	0	Std	-	-
EAFN-1604	0	-	0	0	Std	-	-
EAEP-801	0	Std	0	0	0	0	0
EAEP-802	0	-	0	0	0	-	-
EAEP-1602	0	Std	0	0	0	-	0
EAF-1602 MIX	0	0	0	0	0	-	0
EAF-802 C	0	-	0	0	0	-	-
EAF-1603 C	0	-	0	0	0	-	-
EAF-1604 C	0	-	0	0	0	-	-
EAF-802 P	0	-	0	0	0	-	-
EAF-1603 P	0	-	0	0	0	-	-
EAF-1604 P	0	-	0	0	0	-	-
EAFP-802/2	0	-	0	0	0	-	-
EAFP-1602/2	0	0	0	0	0	-	0
EAFP-1603/2	0	-	0	0	0	-	-
EAFP-1604/2	0	-	0	0	0	-	-
Concept GN-1/1							
EAFP-401	0	0	-	0	0	0	-
EAEP-401	0	Std	-	0	0	0	-
EAFN-401	0	0	-	0	Std	0	-
Concept Snack							
EAFP-701	0	0	-	0	0	0	-
EAFP-702	0	-	-	0	0	-	-
EAFP-1402	0	0	-	0	0	-	-
EAFP-1403	0	-	-	0	0	-	-
EAFP-1404	0	-	-	0	0	-	-
EAFN-701	0	0	-	0	Std	0	-
EAFN-702	0	-	-	0	Std	-	-
EAFN-1402	0	0	-	0	Std	-	-
EAFN-1403	0	-	-	0	Std	-	-
EAFN-1404	0	-	-	0	Std	-	-
EAEP-701	0	Std	-	0	0	0	-
EAEP-1402	0	Std	-	0	0	-	-
EAF-1402-MIX	0	0	-	0	0	-	-
EAF-702 C	0	-	-	0	0	-	-
EAF-1403 C	0	-	-	0	0	-	-
EAF-1404 C	0	-	-	0	0	-	-
EAF-702 P	0	-	-	0	0	-	-
EAF-1403 P	0	-	-	0	0	-	-
EAF-1404 P	0	-	-	0	0	-	-
Concept PASTELERÍA							
EAPP-701	0	0	-	0	0	0	0
Concept PESCADO							
EAP-701	0	0	-	0	0	0	0

Accessories *

FOR MODELS:	ACCESSORY	CODE
SNACK CABINETS	GRID made in Epoxi (560x542)	12034317
	SUPPLEMENTARY GRID made in Epoxi (500x158)	12037946
SNACK CABINETS - FISH COMPARTMENT	DRAWER for Fishes - 530x460x100 mm	12033758
	PERFORATED BOTTOM - 530x460 mm	12034642
	GUIDE for Fish compartment - 613 mm - 1 piece	12036716
SNACK CABINETS - FROZEN COMPARTMENT	DRAWER for Frozen product - 530x540x100 mm	12033784
	GUIDE for Frozen compartment - 562 mm - 1 piece	12037936
GASTRONORM CABINETS	GN-2/1 GRID made in Epoxi (650x530)	12037958
	GN-2/1 GRID Inox. (650x530)	19001000
	GUIDE for GN grid - 562 mm - 1 p.	12037936
GN CABINETS - FISH COMPARTMENT	DRAWER for Fishes - 530x540x100 mm	12033784
	PERFORATED BOTTOM - 530x540 mm	12034707
	GUIDE for Fish compartment - 613 mm - 1 piece	12036716
GN CABINETS - FROZEN COMPARTMENT	DRAWER for Frozen product - 530x540x100 mm	12033784
	GUIDE for Frozen compartment - 662 mm - 1 piece	12037948
FISH CABINETS, PASTRY CABINETS	Pastry GRID made in Epoxi (600x400)	12034886
	Pastry GRID Inox, (600x400)	19001001
	Pastry TRAY Inox, (600x400)	19010201
	GUIDE for Pastry grid - 485 mm - 1 piece	12036689
	Grey DRAWER with handles - 600x400x120 mm	12033925

* Check prices at the list of accessories and spare parts

Castors Kit

DESCRIPTION	CODE	€
KIT 4 CASTORS Ø100 (2 brake + 2 without brake) - CABINETS	19015964	-
KIT 6 CASTORS Ø100 (3 brake + 3 without brake) - MIXED CABINETS	19046863	-



Standard lock



Lock for Glass door



Opening Pedal



Meat bar kit



DESCRIPTION	CODE	FOR MODELS	QUANTITY	€
Meat bar 1 DOOR - GN (Embedded sides)	19048712	EAFP-801/802	1	-
		EAAFP-801		
		EAFN-801/802		
		EAAFN-801	2	
		EAF-1602 MIX		
Meat bar 2 DOORS - GN (Embedded sides)	19048713	EAFP-1602/1603/1604	1	-
		EAAFP-1602/1603/1604		
		EAFN-1602/1603/1604		
		EAAFN-1602/1603/1604		
Meat bar - SNACK SERIES	19048715	EAFP - 701/702	1	-
		EAFN - 701/702		
		EAFP-1402/1403/1404	2	
		EAFN-1402/1403/1404		



Refrigerated Counters

Gastronom 700.....	191
— Advance.....	191
— Concept.....	194
Snack 600.....	207
— Concept.....	207
Pastry 800.....	215
— Concept.....	215

Special units or any variations on the standard model must be assembled at the factory at an additional charge over the standard model's price.

Please, contact Fagor Industrial for any other variation or option that is not included on this list.



Efficiency and quality
for professional needs.



Find out more!







Access the website

We respond to all types of requirement with our broad catalogue of counters.

The Advance range represents Fagor's steadfast commitment to innovation and alignment with the most demanding levels of energy efficiency, obtaining Class A in all refrigeration counters with 2 or 3 doors.

The Concept range is characterised as the more cost-effective line, but with a range breadth unique on the market (GN-700, Snack-600 and Pastry series), thanks to the different options available.

	GASTRONORM - 700		SNACK - 600	PASTRY - 800
	GLOBE ADVANCE	GLOBE CONCEPT	GLOBE CONCEPT	GLOBE CONCEPT
DIMENSIONS (3 doors)	1.800 x 700 x 850	1.792 x 700 x 850	2.017 x 600 x 850	2.017 x 800 x 850
CAPACITY (Nº of levels per door)	6	6	3	10
ENERGY EFFICIENCY CLASS				
INSULATION	60 mm SIDES 50 + 40 mm Double roof	50 mm	50 mm	50 mm
COOLANT	R600a / R290	R600a / R290	R600a / R290	R600a
CLIMATE CLASS	4	4	4	4
AMBIENT TEMPERATURE (*)	43 °C	43 °C	43 °C	43 °C
COOLING SYSTEM	MONOBLOCK	INTERNAL	INTERNAL	INTERNAL CENTRAL
HACCP	YES	NO	NO	NO
ECO MODE	YES	YES	NO	NO
LOCK	IN OPTION Standard with glass doors	IN OPTION Standard with glass doors	IN OPTION Standard with glass doors	IN OPTION
HUMIDITY PROTECTION GRADE	IPX4	IPX4	IPX4	IPX4

(*) AMBIENT TEMPERATURE: Guaranteed operation at 43°C. Excluded display models with glass doors. For specific intensive usage please check with Fagor Commercial Manager.

Advance | 700 Gastronorm

ADVANCE counters are available with 700 mm depth and for Gastronorm size containers. ADVANCE counters have been designed to offer an efficient more profitable and sustainable product to improve daily working conditions.



45% ENERGY
SAVING

General characteristics

- High quality austenitic stainless steel inside and outside (except for galvanised back panel).
- 40 kg/m³ injected polyurethane isolation. 60 mm thick side walls, while the ceiling is 40 mm thick with a 50 mm worktop on it to make a total 90 mm thickness.
- Copper piping and aluminium flaps evaporator.
- HACCP system that keeps running logs.
- Digital display for electronic and digital control of temperature and defrosting.
- The controls are integrated in the front panel for a better protection against dirt. IPX5 compliant, the controls are protected against water splash and jets.
- Acoustic and visual alarm connected to three sensors at strategic spots. They provide a total control and block the compressor in case of dirt or failure.
- Opened door delay alarm.
- Easier loading and unloading thanks to its door self-closing and stay open features.
- Removable and height adjustable plastic covered steel shelves for easy cleaning (GN1/1 size).
- Equipment per door: 1 GN 1/1 grid and 2 sets of height adjustable tray slides.
- Built-in drainage to get rid of waste liquids inside the unit.
- Embedded bottom and curved panels inside for easy cleaning and maintenance.
- Interior LED lighting (only for models with glass doors).
- Height adjustable stainless steel legs.
- 10 cm high splashback.
- Working temperature: from -2 °C to +8 °C (refrigerators) and from -18 °C to -22 °C (freezers).
- Ambient temperature: 43 °C (*)
- Climatic class 4.

Options:

- Castor kit (factory assembly).
- Without splashback.
- Without worktop.
- Different drawer models.
- Left side cooling unit.
- Panoramic door opening.
- Stainless steel back.
- Granite worktops.
- Heated door frame to avoid condensation in high humidity environments.
- Lock (standard in glass doors).

(*) AMBIENT TEMPERATURE: Guaranteed operation at 43°C. Excluded display models with glass doors. For specific intensive usage please check with Fagor Commercial Manager.

Refrigeration
Counters *

Freezer
Counters



EAMFP-225

EAMFN-180

Refrigerated counters
With glass doors



EAMFP-135-PC

Refrigerated
Central counters













EAMCP-180

(*) We can provide granite worktops on our refrigerated counters.
(*) We offer the option of panoramic door opening in models with 2, 3 and 4 doors. (Only solid doors).

VISIBILITY:
Double panel door and anodised aluminium frame with double vacuum chamber.

FLEXIBILITY:
Doors on both sides for enhance flexibility at work.

MODEL	HZ	CODE	NO. OF DOORS	ENERGY EFFICIENCY CLASS	GROSS CAPACITY (L)	ANNUAL ENERGY CONSUMPTION (KW-H)	ELECTRIC POWER (W)	COOLANT	DIMENSIONS (MM)	€
REFRIGERATED COUNTERS										
 EAMFP-135	50	19037783	2	A	258	381	152	R600a	1.350x700x850	-
 EAMFP-180	50	19037784	3	A	403	514	152	R600a	1.800x700x850	-
 EAMFP-225	50	19037785	4	B	549	810	195	R600a	2.250x700x850	-
Freezer COUNTERS										
 EAMFN-135	50 60	19037806 19074306	2	D -	258	2.044 -	615 699	R290	1.350x700x850	-
 EAMFN-180	50 60	19037809 19074308	3	D -	403	2.654 -	624 708	R290	1.800x700x850	-
Refrigerated COUNTERS with glass doors										
 EAMFP-135-CR-PC	50	19037798	2	-	258	-	178	R600a	1.350x700x850	-
 EAMFP-180-CR-PC	50	19037800	3	-	403	-	180	R600a	1.800x700x850	-
 EAMFP-225-CR-PC	50	19037802	4	-	549	-	203	R600a	2.250x700x850	-
Refrigerated central COUNTERS										
 EAMCP-135	50	19037803	2+2	-	258	-	174	R600a	1.350x768x850	-
 EAMCP-180	50	19037804	3+3	-	403	-	174	R600a	1.800x768x850	-
 EAMCP-225	50	19037805	4+4	-	546	-	195	R600a	2.250x768x850	-

Refrigerated counters With drawers *



EAMFP-225-HHHD



EAMFP-180-TTT

VERSATILITY:

Different sets of drawers for the most specific requirements.

ROBUSTNESS:

Our bottom perforated drawers can stand up to 40 kg.

* We have different versions of drawer kits and doors available:
Set 2 drawers (H), Set 3 drawers (T) and Doors (D).

	MODEL	CODE	NO. OF DOORS	ENERGY EFFICIENCY CLASS	GROSS CAPACITY (L)	ANNUAL ENERGY CONSUMPTION (KW-H)	ELECTRIC POWER (W)	COOLANT	DIMENSIONS (MM)	€
REFRIGERATED COUNTERS WITH "H" DRAWERS										
	EAMFP-135-HD	19037786	1 H 1 D	A	258	381	152	R600a	1.350x700x850	-
	EAMFP-135-HH	19037789	2 H	A	258	381	152	R600a	1.350x700x850	-
	EAMFP-180-HDD	19037790	1 H 2 D	A	403	514	173	R600a	1.800x700x850	-
	EAMFP-180-HHD	19037791	2 H 1 D	A	403	514	173	R600a	1.800x700x850	-
	EAMFP-180-HHH	19037792	3 H	A	403	514	173	R600a	1.800x700x850	-
	EAMFP-225-HDDD	19037793	1 H 3 D	B	549	810	195	R600a	2.250x700x850	-
	EAMFP-225-HHDD	19037795	2 H 2 D	B	549	810	195	R600a	2.250x700x850	-
	EAMFP-225-HHHD	19037796	3 H 1 D	B	549	810	195	R600a	2.250x700x850	-
	EAMFP-225-HHHH	19037797	4 H	B	549	810	195	R600a	2.250x700x850	-
REFRIGERATED COUNTERS WITH "T" DRAWERS										
	EAMFP-135-TT	19048245	3T	A	258	381	152	R600a	1.350x700x850	-
	EAMFP-180-TTT	19058976	3T	A	403	514	152	R600a	1.800x700x850	-

Drawers for refrigerated counters

	MODEL	KIT	CODE	TYPE OF COUNTER	POSITION OF THE KIT IN THE UNIT	€
	KIT 2 DRAWERS (1/2+1/2)	H	19012537	ADVANCE Gastronorm		-
	KIT 2 DRAWERS (1/3+2/3)	W	19012538	ADVANCE Gastronorm		-
	KIT 3 DRAWERS (1/3+1/3+1/3)	T	19012539	ADVANCE Gastronorm		-

Concept | 700 Gastronorm

Our 700 mm deep CONCEPT range with capacity for Gastronorm containers provides one of the widest refrigerated counter choices in the market. We provide a wide range of versions and options to suit every user's needs with a robust, ergonomic, functional and easy to clean product.



35% ENERGY
SAVING WITH HC
COOLANTS

General characteristics

- High quality austenitic stainless steel inside and outside (except for galvanised back panel).
 - 50 mm, 40 kg/m³ injected polyurethane insulation.
 - Forced draught cooling system inside the room.
 - Copper piping and aluminium flaps evaporator.
 - Digital display for electronic and digital control of temperature and defrosting.
 - The controls are integrated in the front panel for a better protection against dirt. IPX5 compliant, the controls are protected against water splash and jets.
 - Opened door delay alarm.
 - Easier loading and unloading thanks to its door self-closing and stay open features.
 - Removable and height adjustable plastic covered steel shelves for easy cleaning (GN1/1 size).
 - Equipment per door: 1 GN 1/1 grid and 2 sets of height adjustable tray slides.
 - Built-in drainage to get rid of waste liquids inside the unit.
 - Interior LED lighting (only for models with glass doors).
 - Embedded bottom and curved panels inside for easy cleaning and maintenance.
 - Height adjustable stainless steel legs.
 - 10 cm high splashback.
 - Working temperature: from -2 °C to +8 °C (refrigerators) and from -18 °C to -22 °C (freezers).
 - Ambient temperature: 43 °C (*)
 - Climatic class 4.
- Options:
- Castor kit (factory assembly).
 - Without splashback.
 - Without worktop.
 - Different drawer models.
 - Left side cooling unit.
 - Panoramic door opening.
 - Stainless steel back.
 - Granite worktops.
 - Heated door frame to avoid condensation in high humidity environments.
 - Lock (standard in glass doors).

(*) AMBIENT TEMPERATURE: Guaranteed operation at 43°C. Excluded display models with glass doors. For specific intensive usage please check with Fagor Commercial Manager.

Refrigerated counters

Refrigerated Counters



EMFP-135-GN

Refrigerated counters With pre-installation



EMFP-192-GN-R

ADAPTABILITY:
Units ready for the connection
of a remote cooling unit.
The cooling unit is not included.

	MODEL	COOLANT	HZ.	CODE	N. DOORS	ENERGY EFFICIENCY CLASS	GROSS CAPACITY (L)	ANNUAL ENERGY CONSUMPTION (KW-H)	ELECTRIC POWER (W)	DIMENSIONS (MM)	€
REFRIGERATED COUNTERS											
	EMFP-135-GN	R600a R290	50	19036976	2	B	274	752	203	1.342x700x850	-
			60	19073998		-		-	295		
	EMFP-180-GN	R600a R290	50	19036983	3	C	428	931	203	1.792x700x850	-
			60	19074329		-		-	295		
	EMFP-225-GN	R600a	50	19036995	4	C	581	1.096	224	2.242x700x850	-
			60	19073991		-		-	241		
REFRIGERATED COUNTERS WITH PRE-INSTALLATION											
	EMFP-102-GN-R	-	50/60	19037590	2	-	274	-	29	1.042x700x850	-
	EMFP-147-GN-R	-	50/60	19037591	3	-	428	-	29	1.492x700x850	-
	EMFP-192-GN-R	-	50/60	19037592	4	-	581	-	29	1.942x700x850	-

Freezer counters

Freezer Counters

Freezer counters With pre-installation



EMFN-180-GN



EMFN-102-GN-R

ADAPTABILITY:
Units ready for the connection
of a remote cooling unit.
The cooling unit is not included.

	MODEL	COOLANT	HZ.	CODE	N. DOORS	ENERGY EFFICIENCY CLASS	GROSS CAPACITY (L)	ANNUAL ENERGY CONSUMPTION (KW-H)	ELECTRIC POWER (W)	DIMENSIONS (MM)	€
FREEZER COUNTERS											
🚚	EMFN-135-GN	R290	50	19037545	2	D	274	2.212	667	1.342x700x850	-
			60	19074330		-		737			
🚚	EMFN-180-GN	R290	50	19037550	3	D	428	2.467	676	1.792x700x850	-
			60	19073268		-		746			
FREEZER COUNTERS WITH PRE-INSTALLATION											
	EMFN-102-GN-R		50/60	19037636	2	-	274	-	414	1.042x700x850	-
	EMFN-147-GN-R		50/60	19037637	3	-	428	-	423	1.492x700x850	-

Refrigerated counters With drawers (*)











EMFP-180-GN HHH









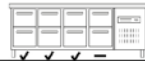

EMFP-135-GN HD

ROBUSTNESS:
Our perforated stainless steel drawers
can stand loads up to 40 kg.

(*) We have different versions of drawer kits
and doors available
Set 2 drawers (H)
Doors (D)

MODEL	COOLANT	HZ.	CODE	N. DOORS AND DRAWERS	ENERGY EFFICIENCY CLASS	GROSS CAPACITY (L)	ANNUAL ENERGY CONSUMPTION (KW-H)	ELECTRIC POWER (W)	DIMENSIONS (MM)	€
REFRIGERATED COUNTERS WITH DRAWERS										
 EMFP-135-GN HD	R600a	50	19036978	1 H 1 D	C	274	752	203	1.342x700x850	-
 EMFP-135-GN HH	R600a	50	19036979	2 H	C		752	203		-
 EMFP-180-GN HDD	R600a	50	19036985	1 H 2 D	C	428	931	203	1.792x700x850	-
 EMFP-180-GN HHD	R600a	50	19036986	2 H 1 D	C		931	203		-
 EMFP-180-GN HHH	R600a	50	19036992	3 H	C	931	203	-		-
 EMFP-225-GN HDDD	R600a	50	19036997	1 H 3 D	C	581	1.096	224	2.242x700x850	-
 EMFP-225-GN HHDD	R600a	50	19036998	2 H 2 D	C		1.096	224		-
 EMFP-225-GN HHHH	R600a	50	19036999	3 H 1 D	C		1.096	224		-
 EMFP-225-GN HHHH	R600a	50	19037000	4 H	C	1.096	224	-		-

Drawers for refrigerated counters









MODEL	KIT	CODE	TYPE OF COUNTER	POSITION OF THE KIT IN THE UNIT	€
 KIT 2 DRAWERS (1/2+1/2)	H	19010993	CONCEPT Gastronorm		-
 KIT 2 DRAWERS (1/2+1/2) RIGHT	H	19015952	CONCEPT Gastronorm		-
 KIT 2 DRAWERS (1/2+1/2) LEFT	H	19036401	CONCEPT Gastronorm		-
 KIT 2 DRAWERS (1/3+2/3)	W	19015953	CONCEPT Gastronorm		-
 KIT 3 DRAWERS (1/3+1/3+1/3)	T	19015954	CONCEPT Gastronorm		-

Refrigerated counters with drawers And pre-installation



EMFP-192-GN HHDD-R

ADAPTABILITY:
Units ready for the connection
of a remote cooling unit.
The cooling unit is not included.

MODEL	COOLANT	HZ.	CODE	N. DOORS AND DRAWERS	ENERGY EFFICIENCY CLASS	GROSS CAPACITY (L)	ANNUAL ENERGY CONSUMPTION (KW-H)	ELECTRIC POWER (W)	DIMENSIONS (MM)	€
REFRIGERATED COUNTERS WITH DRAWERS WITH PRE-INSTALLATION										
 EMFP-102-GN-R HD	-	50/60	19037613	1 H 1 D	-	274	-	-	1.042x700x850	-
 EMFP-102-GN-R HH	-	50/60	19037615	2 H	-		-	-		-
 EMFP-147-GN-R HDD	-	50/60	19037616	1 H 2 D	-	428	-	-	1.492x700x850	-
 EMFP-147-GN-R HHD	-	50/60	19037619	2 H 1 D	-		-	-		-
 EMFP-147-GN-R HHH	-	50/60	19037630	3 H	-	-	-	-	-	
 EMFP-192-GN-R HDDD	-	50/60	19037631	1 H 3 D	-	581	-	-	1.942x700x850	-
 EMFP-192-GN-R HHDD	-	50/60	19037632	2 H 2 D	-		-	-		-
 EMFP-192-GN-R HHHD	-	50/60	19037633	3 H 1 D	-	-	-	-	-	
 EMFP-192-GN-R HHHH	-	50/60	19037635	4 H	-	-	-	-	-	

Refrigerated counters with glass doors

Refrigerated counters With glass doors



EMFP-180-GN CR PC







VISIBILITY:
Double pane door and anodised aluminium frame
with double vacuum chamber.

Refrigerated counters With glass doors and pre-installation



EMFP-102-GN-R CR PC

ADAPTABILITY:
Units ready for the connection of a remote cooling unit.
The cooling unit is not included.

MODEL	COOLANT	HZ.	CODE	N. DOORS	ENERGY EFFICIENCY CLASS	GROSS CAPACITY (L)	ANNUAL ENERGY CONSUMPTION (KW-H)	ELECTRIC POWER (W)	DIMENSIONS (MM)	€
REFRIGERATED COUNTERS WITH GLASS DOORS										
 EMFP-135-GN CR PC	R600a	50	19036977	2	-	274	-	205	1.342x700x850	-
 EMFP-180-GN CR PC	R600a	50	19036984	3	-	428	-	207	1.792x700x850	-
 EMFP-225-GN CR PC	R600a	50	19036996	4	-	581	-	230	2.242x700x850	-
REFRIGERATED COUNTERS WITH GLASS DOORS AND PRE-INSTALLATION										
 EMFP-102-GN-R CR PC	-	50/60	19037609	2	-	274	-	-	1.042x700x850	-
 EMFP-147-GN-R CR PC	-	50/60	19037611	3	-	428	-	-	1.492x700x850	-
 EMFP-192-GN-R CR PC	-	50/60	19037612	4	-	581	-	-	1.942x700x850	-

Refrigerated counters With sink



EMFP-225-GN F

SINK:
(330 x 365 x 140 mm) sink included
with rinse grid on the worktop.

Refrigerated Central counters



EMCP-180-GN

FLEXIBILITY:
Doors on both sides for easier reaching in.

Refrigerated counters with sink

	MODEL	COOLANT	HZ.	CODE	N. DOORS	ENERGY EFFICIENCY CLASS	GROSS CAPACITY (L)	ANNUAL ENERGY CONSUMPTION (KW-H)	ELECTRIC POWER (W)	DIMENSIONS (MM)	€
REFRIGERATED COUNTERS WITH SINK											
	EMFP-135-GN-F	R600a	50	19036982	2	B	274	752	203	1.342x700x850	-
	EMFP-180-GN-F	R600a	50	19036993	3	C	428	931	203	1.792x700x850	-
	EMFP-225-GN-F	R600a	50	19037001	4	C	581	1.096	224	2.242x700x850	-

Refrigerated central counters

	MODEL	COOLANT	HZ.	CODE	N. DOORS	ENERGY EFFICIENCY CLASS	GROSS CAPACITY (L)	ANNUAL ENERGY CONSUMPTION (KW-H)	ELECTRIC POWER (W)	DIMENSIONS (MM)	€
REFRIGERATED CENTRAL COUNTERS											
	EMCP-135-GN	R600a	50	19037012	2+2	-	274	-	203	1.342x768x850	-
	EMCP-180-GN	R600a	50	19037013	3+3	-	428	-	203	1.792x768x850	-
	EMCP-225-GN	R600a	50	19037014	4+4	-	581	-	224	2.242x768x850	-

Refrigerated bases

Intended to give support to counter top cooking equipment. Ideal for refrigeration solutions in small rooms.

Models with doors



EMFP-180-BP

Models with drawers 1/3 et 2/3



EMFP-180-B2

	MODEL	COOLANT	HZ.	CODE	N. DOORS AND DRAWERS	ENERGY EFFICIENCY CLASS	GROSS CAPACITY (L)	ANNUAL ENERGY CONSUMPTION (KW-H)	ELECTRIC POWER (W)	DIMENSIONS (MM)	€
REFRIGERATED BASES WITH DOORS											
	EMFP-135-BP	R600a R290	50	19037038	2	C	177	752	202	1.342x700x584	-
			60	19074511							
	EMFP-180-BP	R600a R290	50	19037042	3	C	277	931	202	1.792x700x584	-
			60	19074512							
	EMFP-225-BP	R600a	50	19037048	4	D	377	1096	224	2.242x700x584	-
			60	19074515							
REFRIGERATED BASES WITH 2/3 DRAWERS											
	EMFP-135-B	R600a R290	50	19037039	2 x 2/3	C	177	752	202	1.342x700x584	-
			60	19074511							
	EMFP-180-B	R600a R290	50	19037043	3 x 2/3	C	277	931	202	1.792x700x584	-
			60	19074512							
	EMFP-225-B	R600a	50	19037049	4 x 2/3	C	377	1.096	224	2.242x700x584	-
			60	19074515							
REFRIGERATED BASES WITH 1/3 AND 2/3 DRAWERS											
	EMFP-135-B2	R600a R290	50	19037040	2 x 1/3 1 x 2/3	C	177	752	202	1.342x700x584	-
			60	19074511							
	EMFP-180-B2	R600a R290	50	19037044	4 x 1/3 1 x 2/3	C	277	931	202	1.792x700x584	-
			60	19074512							
	EMFP-225-B2	R600a	50	19037050	6 x 1/3 1 x 2/3	D	377	1.096	224	2.242x700x584	-
			60	19074515							

Refrigerated stands Kore 900



General characteristics

- Sealed compressor with ventilated condenser.
- Copper pipe evaporator with aluminum wings.
- 50 mm injected polyurethane insulation with a density of 40kg/m³.
- BP models with panoramic door opening and automatic closing device with stay open feature above 90°.
- Height adjustable stainless-steel legs (from 130mm to 190mm) allows adjusting the overall height of the counter from 580 to 640mm.

- Forced air refrigeration system
- Working temperature: -2 °C, +8 °C, at room temperature of 38 °C.
- Climate Class 4
- Electronic temperature and defrosting control and display.
- BP model with doors and B model with GN 1/1 holding capacity drawers.
- BH model with a full-length flat drawer with GN2/1 holding capacity and equipped with 5 crosspieces to support different combinations of GN containers.

- Options:
- Kit of 6 castors (2 with brakes). Factory fitted.
 - 60Hz

MODEL	COOLANT	HZ.	CODE	N. DOORS AND DRAWERS	ENERGY EFFICIENCY CLASS	GROSS CAPACITY (L)	ANNUAL ENERGY CONSUMPTION (KW-H)	ELECTRIC POWER(W)	DIMENSIONS (MM)	€
MODELS WITH DOORS										
EMFP9-120 BP	R290	50	19048089	2	C	169	714	250	1.200x900x590	-
MODELS WITH 2/3 DRAWERS										
EMFP9-120 B	R290	50	19048090	2 x 2/3	C	169	714	250	1.200x900x590	-
MODELS WITH FULL LENGTH FLAT DRAWERS										
EMFP9-120 BH	R290	50	19047995	2 x GN 2/1	C	169	777	250	1.200x900x590	-

MODEL	COOLANT	HZ.	CODE	N. DOORS AND DRAWERS	ENERGY EFFICIENCY CLASS	GROSS CAPACITY (L)	ANNUAL ENERGY CONSUMPTION (KW-H)	ELECTRIC POWER(W)	DIMENSIONS (MM)	€
MODELS WITH DOORS										
EMFP9-160 BP	R290	50	19068878	3	C	240	1113	250	1.600x900x590	-
MODELS WITH 2/3 DRAWERS										
EMFP9-160 B	R290	50	19068870	3 x GN 1/1	C	240	1113	250	1.600x900x590	-

Refrigerated stands

General characteristics

- Sealed compressor with ventilated condenser.
 - Copper pipe evaporator with aluminum wings.
 - 50 mm injected polyurethane insulation with a density of 40kg/m³.
 - BP models with panoramic door opening and automatic closing device with stay open feature above 90°.
 - Height adjustable stainless-steel legs (from 130mm to 190mm) allows adjusting the overall height of the counter from 580 to 640mm.
 - Forced air refrigeration system.
 - Working temperature: -2 °C, +8 °C, at room temperature of 38 °C.
 - Climate Class 4.
 - Electronic temperature and defrosting control and display.
 - BP model with doors and B model with GN 2/3 holding capacity drawers.
 - BH model with a full-length flat drawer with 2XGN2/3 holding capacity and equipped with 5 crosspieces to support different combinations of GN containers.
- Options:
- Kit of 6 castors (2 with brakes). Factory fitted.
 - 60Hz.

MODEL	COOLANT	HZ.	CODE	N. DOORS AND DRAWERS	ENERGY EFFICIENCY CLASS	GROSS CAPACITY (L)	ANNUAL ENERGY CONSUMPTION (KW-H)	ELECTRIC POWER(W)	DIMENSIONS (MM)	€
MODELS WITH DOORS										
EMFP7-120 BP	R290	50	19074945	2	C	110	657	250	1200x630x590	-
MODELS WITH 2/3 DRAWERS										
EMFP7-120 B	R290	50	19074943	2 x GN 2/3	C	110	657	250	1200x630x590	-
MODELS WITH FULL LENGTH FLAT DRAWERS										
EMFP7-120 BH	R290	50	19075072	2 x GN 4/3	c	110	777	250	1200x630x590	-

MODEL	COOLANT	HZ.	CODE	N. DOORS AND DRAWERS	ENERGY EFFICIENCY CLASS	GROSS CAPACITY (L)	ANNUAL ENERGY CONSUMPTION (KW-H)	ELECTRIC POWER(W)	DIMENSIONS (MM)	€
MODELS WITH DOORS										
EMFP7-160 BP	R290	50	19076353	3	C	169	1113	250	1.600x630x590	-
MODELS WITH 2/3 DRAWERS										
EMFP7-160 B	R290	50	19076352	3 x GN 2/3	C	169	1113	250	1.600x630x590	-

















GN counters - available options and price increase per model

MODEL	ST. STEEL BACK PANEL (€)	3 CM GRANITE WORKTOP (€)	WITHOUT WORKTOP (€)	WITHOUT SPLASHBACK (€)	WHEELS SET (€)	LOCK (PER DOOR) (€)	DRAWERS SET [1/2] UNIT (€)	DRAWERS SET [1/3] UNIT (€)	COMPRESSOR ON THE LEFT (€)	HEATED DOOR FRAME (€)	PANORAMIC OPENING (€)
	RI	GR	SE	SP	R	CR	H	T	GI	T	AP
ADVANCE - 700 GASTRONORM											
EAMFP-135 GN	0	0	0	0	0	0	0	0	-	0	0
EAMFP-180 GN	0	0	0	0	0	0	0	0	-	0	0
EAMFP-225 GN	0	0	0	0	0	0	0	0	-	0	0
EAMFN-135 GN	0	0	0	0	0	0	-	-	-	STD	0
EAMFN-180 GN	0	0	0	0	0	0	-	-	-	STD	0
EAMFP-135 GN-PC	0	0	0	0	0	STD	-	-	-	0	-
EAMFP-180 GN-PC	0	0	0	0	0	STD	-	-	-	0	-
EAMFP-225 GN-PC	0	0	0	0	0	STD	-	-	-	0	-
EAMCP-135 GN	-	0	0	STD	0	0	-	-	-	0	0
EAMCP-180 GN	-	0	0	STD	0	0	-	-	-	0	0
EAMCP-225 GN	-	0	0	STD	0	0	-	-	-	0	0
CONCEPT - 700 GASTRONORM											
EMFP-135 GN	0	0	0	0	0	0	0	0	0	0	0
EMFP-180 GN	0	0	0	0	0	0	0	0	0	0	0
EMFP-225 GN	0	0	0	0	0	0	0	0	0	0	0
EMFN-135 GN	0	0	0	0	0	0	-	-	0	STD	0
EMFN-180 GN	0	0	0	0	0	0	-	-	0	STD	0
EMFP-135 GN-PC	0	0	0	0	0	STD	-	-	0	0	-
EMFP-180 GN-PC	0	0	0	0	0	STD	-	-	0	0	-
EMFP-225 GN-PC	0	0	0	0	0	STD	-	-	0	0	-
EMFP-135 GN-F	0	-	-	0	-	0	0	0	-	0	0
EMFP-180 GN-F	0	-	-	0	-	0	0	0	-	0	0
EMFP-225 GN-F	0	-	-	0	-	0	0	0	-	0	0
EMFP-135 BP	0	-	-	STD	0	0	-	-	-	0	-
EMFP-180 BP	0	-	-	STD	0	0	-	-	-	0	-
EMFP-225 BP	0	-	-	STD	0	0	-	-	-	0	-
EMCP-135 GN	-	0	0	STD	0	0	-	-	-	0	0
EMCP-180 GN	-	0	0	STD	0	0	-	-	-	0	0
EMCP-225 GN	-	0	0	STD	0	0	-	-	-	0	0
EMFP-102 GN-R	0	0	0	0	-	0	0	0	-	0	0
EMFP-147 GN-R	0	0	0	0	-	0	0	0	-	0	0
EMFP-192 GN-R	0	0	0	0	-	0	0	0	-	0	0
EMFN-102 GN-R	0	0	0	0	-	0	-	-	-	0	0
EMFN-147 GN-R	0	0	0	0	-	0	-	-	-	0	0
EMFP-102 GN-R PC	0	0	0	0	-	STD	-	-	-	0	-
EMFP-147 GN-R PC	0	0	0	0	-	STD	-	-	-	0	-
EMFP-192 GN-R PC	0	0	0	0	-	STD	-	-	-	0	-

* Applies to all refrigeration front counters (B, BP, B2).

Drawers for refrigerated counters

MODEL	KIT	CODE	TYPE OF COUNTER	POSITION OF THE KIT IN THE UNIT	€
 KIT 2 DRAWERS (1/2+1/2)	H	19012537	ADVANCE Gastronorm		-
 KIT 2 DRAWERS (1/3+2/3)	W	19012538	ADVANCE Gastronorm		-
 KIT 3 DRAWERS (1/3+1/3+1/3)	T	19012539	ADVANCE Gastronorm		-
KIT 2 DRAWERS (1/2+1/2)	H	19010993	CONCEPT Gastronorm		-
 KIT 2 DRAWERS (1/2+1/2) RIGHT	H	19015952	CONCEPT Gastronorm		-
 KIT 2 DRAWERS (1/2+1/2) LEFT	H	19036401	CONCEPT Gastronorm		-
 KIT 2 DRAWERS (1/3+2/3)	W	19015953	CONCEPT Gastronorm		-
 KIT 3 DRAWERS (1/3+1/3+1/3)	T	19015954	CONCEPT Gastronorm		-

Kits castors to assembly

DESCRIPTION	CODE	€
KIT 4 WHEELS, 2 with bracked	19016846	-
KIT 6 WHEELS, 3 with bracked	19011005	-

Accessories for gn counters *

DESCRIPTION	CODE
GRID GN 1/1 Epoxi (530x325)	12035781
GRID GN 1/1 Stainless steel (530x325)	19000999
GUIDE for grid GN-1/1 - Side grid - 562 mm - 1 element	12037936
GUIDE for grid GN-1/1 - Central grid - 612 mm - 1 element	12036716
GUIDE for grid GN-1/1 - ADVANCE counters - Side and Central - 519 mm - 1 element	12036880

* Check prices at accessories and spare parts list

Panoramic Opening (AP)



(#) PANORAMIC OPENING - possible OPTIONS

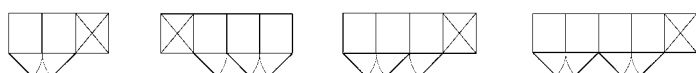

Concept | 600 Snack

Our 600 mm deep CONCEPT range with Snack dimensions offers a wide choice of refrigerated counter worktops to fit into reduced spaces with a robust, ergonomic, functional and easy to clean product.



60% ENERGY
SAVING WITH HC
COOLANTS

General characteristics

- High quality austenitic stainless steel inside and outside (except for galvanised back panel).
- 50 mm, 40 kg/m³ injected polyurethane insulation.
- Forced draught cooling system inside the room.
- Copper piping and aluminium flaps evaporator.
- Digital display for electronic and digital control of temperature and defrosting.
- Opened door delay alarm.
- Easier loading and unloading thanks to its door self-closing and stay open features.
- Removable and height adjustable plastic covered steel shelves for easy cleaning.

- Grid self-dimensions: 405 x 460 mm.
- Equipment: 1 grid per door and 1 set of tray slides.
- Built-in drainage to get rid of waste liquids inside the unit.
- Interior LED lighting (only for models with glass doors).
- Embedded bottom and curved panels inside for easy cleaning and maintenance.
- Height adjustable stainless steel legs.
- 10 cm high splashback.
- Working temperature: from -2 °C to +8 °C (refrigerators) and from -18 °C to -22 °C (freezers).
- Ambient temperature: 43 °C (*)
- Climatic class 4.

- Options:
- Castor kit (factory assembly).
 - Without splashback.
 - Without worktop.
 - Different drawer models.
 - Left side cooling unit.
 - Panoramic door opening.
 - Stainless steel back.
 - Lock (standard in glass doors).
 - Heated door frame to avoid condensation in high humidity environments.

(*) AMBIENT TEMPERATURE: Guaranteed operation at 43°C. Excluded display models with glass doors. For specific intensive usage please check with Fagor Commercial Manager.



Refrigerated counters

Refrigerated
Counters

EMSP-150

Refrigerated counters
With pre-installation (*)

EMSP-169-R

* ADAPTABILITY:
Units ready for the connection
of a remote cooling unit.
The cooling unit is not included.

	MODEL	COOLANT	HZ.	CODE	N. DOORS	ENERGY EFFICIENCY CLASS	GROSS CAPACITY (L)	ANNUAL ENERGY CONSUMPTION	ELECTRIC POWER (W)	DIMENSIONS (MM)	€
REFRIGERATED COUNTERS											
	EMSP-150	R600a R290	50	19036912	2	C	268	836	203	1.492x600x850	-
			60	19074528		-		-	295		
	EMSP-200	R600a R290	50	19036970	3	C	416	931	203	2.017x600x850	-
			60	19074529		-		-	295		
	EMSP-250	R600a	50	19037002	4	C	564	1.096	224	2.542x600x850	-
			60	19074530		-		-	241		
REFRIGERATED COUNTERS WITH PRE-INSTALLATION											
	EMSP-117-R	-	50/60	19037640	2	-	268	-	-	1.192x600x850	-
	EMSP-169-R	-	50/60	19037641	3	-	416	-	-	1.717x600x850	-
	EMSP-222-R	-	50/60	19037642	4	-	564	-	-	2.242x600x850	-

Freezer counters

Freezer Counters







EMSN-200-GN

Freezer counters With pre-installation (*)



EMSN-117-R

* ADAPTABILITY:
Units ready for the connection
of a remote cooling unit.
The cooling unit is not included.

MODEL	COOLANT	HZ.	CODE	N. DOORS	ENERGY EFFICIENCY CLASS	GROSS CAPACITY (L)	ANNUAL ENERGY CONSUMPTION	ELECTRIC POWER (W)	DIMENSIONS (MM)	€
FREEZER COUNTERS										
 EMSN-150	R290	50	19037552	2	D	268	2.212	669	1.492x600x850	-
		60	19074531		-		-	739		
 EMSN-200	R290	50	19037553	3	D	416	2.467	679	2.017x600x850	-
		60	19074532		-		-	749		
FREEZER COUNTERS WITH PRE-INSTALLATION										
 EMSN-117-R	-	50/60	19037666	2	-	268	-	416	1.192x600x850	-
 EMSN-169-R	-	50/60	19037668	3	-	416	-	426	1.717x600x850	-

Refrigerated counters with drawers



ROBUSTNESS:
Our perforated stainless steel drawers
can stand loads up to 40 kg.

We have different versions of drawer kits and doors available
Set 2 drawers (H)
Doors (D)

MODEL	COOLANT	HZ.	CODE	N. DOORS AND DRAWERS	ENERGY EFFICIENCY CLASS	GROSS CAPACITY (L)	ANNUAL ENERGY CONSUMPTION (KW-H)	ELECTRIC POWER (W)	DIMENSIONS (MM)	€	
REFRIGERATED COUNTERS WITH DRAWERS											
	EMSP-150-HD	R600a	50	19036948	1 H 1 D	C	268	836	203	1.492x600x850	-
	EMSP-150-HH	R600a	50	19036953	2 H	C		836	203	-	
	EMSP-200-HDD	R600a	50	19036973	1 H 2 D	C	416	931	203	-	
	EMSP-200-HHD	R600a	50	19036974	2 H 1 D	C		931	203	2.017x600x850	-
	EMSP-200-HHH	R600a	50	19036975	3 H	C		931	203	-	
	EMSP-250-HDDD	R600a	50	19037006	1 H 3 D	C	564	1.096	224	-	
	EMSP-250-HHDD	R600a	50	19037007	2 H 2 D	C		1.096	224	2.542x600x850	-
	EMSP-250-HHHD	R600a	50	19037008	3 H 1 D	C		1.096	224	-	
	EMSP-250-HHHH	R600a	50	19037009	4 H	C	1.096	224	-		









Drawers for snack refrigerated counters

MODEL	KIT	CODE	TYPE OF COUNTER	POSITION OF THE KIT IN THE UNIT	€
KIT 2 DRAWERS (1/2+1/2)	H	19004925	Snack		-
 KIT 2 DRAWERS (1/2+1/2) RIGHT	H	19004921	Snack		-
 KIT 2 DRAWERS (1/2+1/2) LEFT	H	19004930	Snack		-
 KIT 2 DRAWERS (1/3+2/3)	W	19004927	Snack		-
 KIT 3 DRAWERS (1/3+1/3+1/3)	T	19004923	Snack		-

Refrigerated counters with drawers and pre-installation



ADAPTABILITY:
Units ready for the connection
of a remote cooling unit.
The cooling unit is not included.

MODEL	COOLANT	HZ.	CODE	N. DOORS AND DRAWERS	ENERGY EFFICIENCY CLASS	GROSS CAPACITY (L)	ANNUAL ENERGY CONSUMPTION (KW-H)	ELECTRIC POWER (W)	DIMENSIONS (MM)	€
REFRIGERATED COUNTERS WITH DRAWERS AND PRE-INSTALLATION										
 EMSP-117-R HD	-	50/60	19037645	1 H 1 D	-	268	-	-	1.192x600x850	-
 EMSP-117-R HH	-	50/60	19037646	2 H	-	268	-	-	1.192x600x850	-
 EMSP-169-R HDD	-	50/60	19037648	1 H 2 D	-	416	-	-	1.717x600x850	-
 EMSP-169-R HHD	-	50/60	19037649	2 H 1 D	-	416	-	-	1.717x600x850	-
 EMSP-169-R HHH	-	50/60	19037650	3 H	-	416	-	-	1.717x600x850	-
 EMSP-222-R HDDD	-	50/60	19037651	1 H 3 D	-	564	-	-	2.242x600x850	-
 EMSP-222-R HHDD	-	50/60	19037652	2 H 2 D	-	564	-	-	2.242x600x850	-
 EMSP-222-R HHHD	-	50/60	19037654	3 H 1 D	-	564	-	-	2.242x600x850	-
 EMSP-222-R HHHH	-	50/60	19037655	4 H	-	564	-	-	2.242x600x850	-

Refrigerated counters with glass doors

Refrigerated counters
With glass doors

EMSP-150-PC

VISIBILITY:
Double pane door and anodised aluminium frame with double vacuum chamber.

Refrigerated counters
With sink

EMSP-150-F

SINK:
Sink dimensions: 330 x 365 x 140 mm

Refrigerated counters with glass doors

	MODEL	COOLANT	HZ.	CODE	N. DOORS	ENERGY EFFICIENCY CLASS	GROSS CAPACITY (L)	ANNUAL ENERGY CONSUMPTION (KW-H)	ELECTRIC POWER (W)	DIMENSIONS (MM)	€
	EMSP-150-CR-PC	R600a	50	19036937	2	-	268	-	207	1.492x600x850	-
	EMSP-200-CR-PC	R600a	50	19036972	3	-	416	-	209	2.017x600x850	-
	EMSP-250-CR-PC	R600a	50	19037004	4	-	564	-	232	2.542x600x850	-

Refrigerated counters with sink

	MODEL	COOLANT	HZ.	CODE	N. DOORS	ENERGY EFFICIENCY CLASS	GROSS CAPACITY (L)	ANNUAL ENERGY CONSUMPTION (KW-H)	ELECTRIC POWER (W)	DIMENSIONS (MM)	€
	EMSP-150-F	R600a	50	19036915	2	C	268	836	203	1.492x600x850	-
	EMSP-200-F	R600a	50	19036971	3	C	416	931	203	2.017x600x850	-
	EMSP-250-F	R600a	50	19037003	4	C	564	1.096	224	2.542x600x850	-

Drawers for snack refrigerated counters

MODEL	KIT	CODE	TYPE OF COUNTER	POSITION OF THE KIT IN THE UNIT	€
KIT 2 DRAWERS (1/2+1/2)	H	19004925	Snack		-
KIT 2 DRAWERS (1/2+1/2) RIGHT	H	19004921	Snack		-
KIT 2 DRAWERS (1/2+1/2) LEFT	H	19004930	Snack		-
KIT 2 DRAWERS (1/3+2/3)	W	19004927	Snack		-
KIT 3 DRAWERS (1/3+1/3+1/3)	T	19004923	Snack		-

Snack counters - available options and price increase per model

MODEL	ST. STEEL BACK PANEL (€)	3 CM GRANITE WORKTOP (€)	WITHOUT WORKTOP (€)	WITHOUT SPLASHBACK (€)	WHEELS SET (€)	LOCK (PER DOOR) (€)	DRAWERS SET [1/2] UNIT (€)	DRAWERS SET [1/3] UNIT (€)	COMPRESSOR ON THE LEFT (€)	HEATED DOR FRAME (€)	PANORAMIC OPENING (€)
	RI	GR	SE	SP	R	CR	H/W	T	GI	T	AP
GLOBE - 600 SNACK											(#)
EMSP-150	0	-	0	0	0	0	0	0	0	0	0
EMSP-200	0	-	0	0	0	0	0	0	0	0	0
EMSP-250	0	-	0	0	0	0	0	0	0	0	0
EMSN-150	0	-	0	0	0	0	-	-	0	Std	0
EMSN-200	0	-	0	0	0	0	-	-	0	Std	0
EMSP-150-PC	0	-	0	0	0	Std	-	-	0	0	-
EMSP-200-PC	0	-	0	0	0	Std	-	-	0	0	-
EMSP-250-PC	0	-	0	0	0	Std	-	-	0	0	-
EMSP-150-F	0	-	-	0	-	0	0	0	-	0	0
EMSP-200-F	0	-	-	0	-	0	0	0	-	0	0
EMSP-250-F	0	-	-	0	-	0	0	0	-	0	0
EMSP-117-R	0	-	0	0	-	0	0	0	-	0	0
EMSP-169-R	0	-	0	0	-	0	0	0	-	0	0
EMSP-222-R	0	-	0	0	-	0	0	0	-	0	0
EMSN-117-R	0	-	0	0	-	0	-	-	-	Std	0
EMSN-169-R	0	-	0	0	-	0	-	-	-	Std	0

(#) PANORAMIC OPENING - possible OPTIONS

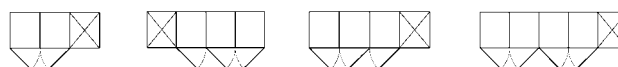

Kit castors for counters

DESCRIPTION	CODE	€
KIT 4 WHEELS Ø 80, 2 with bracket - For 2 and 3 doors counters	19016846	-
KIT 6 WHEELS Ø 80, 3 with bracket - For 4 doors counters	19011005	-

Accessories *

DESCRIPTION	CODE
Side GRID Epoxi (405x460)	12034975
Central GRID Epoxi (405x525)	12034847
Support for Snack GRID	12037728

* Check prices at accessories and spare parts list



Concept | Pastry counters - depth 800 mm

Pastry counters complete our offer for equipment specially designed for this industry.



General characteristics

- High quality austenitic stainless steel inside and outside (except for galvanised back panel).
- 50 mm, 40 kg/m³ injected polyurethane insulation.
- Natural draught cooling system.
- Vertical evaporator to allow a larger storage capacity.
- Digital display for electronic and digital control of temperature and defrosting.
- The controls are integrated in the front panel for a better protection against dirt. IPX5 compliant, the controls are protected against water splash and jets.
- Opened door delay alarm.
- Easier loading and unloading thanks to its door self-closing and stay open features.
- Removable and height adjustable plastic covered steel shelves for easy cleaning (600 x 400 mm).
- Equipment per door: 1 600 x 400 mm grid and 2 sets of height adjustable tray slides.
- Built-in drainage to get rid of waste liquids inside the unit.
- Embedded bottom and curved panels inside for easy cleaning and maintenance.
- Height adjustable stainless steel legs.
- 10 cm high splashback.
- Working temperature: -2 °C, +8 °C.
- Ambient temperature: 43 °C (*)
- Climatic class 4.

MODEL	HZ.	CODE	NO. OF DOORS	GROSS CAPACITY (L)	ELECTRIC POWER (W)	COOLANT	DIMENSIONS (MM)	€
 EMPP-150-GV	50	19037745	2	376	220	R290	1.492x800x850	-
 EMPP-202-GV	50	19037746	3	584	303	R290	2.017x800x850	-
 EMPP-255-GV	50	19037747	4	792	303	R290	2.542x800x850	-

(*) AMBIENT TEMPERATURE: Guaranteed operation at 43°C. For specific intensive usage please check with Fagor Commercial Manager.

Pastry counters - available options and price increase per model

MODEL	ST. STEEL BACK PANEL RI	3 CM GRANITE WORKTOP GR	WITHOUT WORKTOP SE	WITHOUT SPLASHBACK SP	WHEELS SET	LOCK (PER DOOR)	HEATED DOOR FRAME	PANORAMIC OPENING (#)
	(€)	(€)	(€)	(€)	(€)	(€)	(€)	(€)
EMPP-150	-	-	-	-	-	-	-	-
EMPP-202	-	-	-	-	-	-	-	-
EMPP-255	-	-	-	-	-	-	-	-

(#) Panoramic opening - possible options

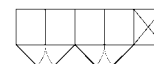

Kit castors for counters

DESCRIPTION	CODE	€
KIT 4 WHEELS Ø 80, 2 with bracket - For 2 and 3 doors counters	19016846	-
KIT 6 WHEELS Ø 80, 3 with bracket - For 4 doors counters	19011005	-

Accessories *

DESCRIPTION	CODE
GRID - Epoxi (600x400)	12034886
GRID - Stainless steel, (600x400)	19001001
PASTRY CONTAINER - Stainless steel, (600x400)	19010201
SIDE GUIDE for grid - 649 mm - 1 element	12036419
CENTRAL GUIDE for grid - 711 mm - 1 element	12038109

* Assembly available on demand.



Preparation Counters

Configurable pizza counters	221
Compact pizza counter, professional series	223
Compact pizza counter, standard serie	225
Sandwich & Salad counter	227
Saladette	229

Special units or any variations on the standard model must be assembled at the factory at an additional charge over the standard model's price.

Please, contact Fagor Industrial for any other variation or option that is not included on this list.



Special tables
for specific tasks.



Find out more!



Access the website





We offer special tables designed for preparing specific foods: pizzas, salads, sandwiches.
 We also provide the option of customising tables to the needs of each customer, combining optional elements with our special tables.

	FOR PIZZA				FOR SALADS AND SANDWICHES		
	CONFIGURABLES		COMPACTS		SALADS	SALADETTES	
	700 MM	800 MM	PROFESSIONALS	STANDARD	EMEP-135/180	EMEP-100	EMEP-100-G
Dimensions (2 doors)	1.342x700x850	1.492x800x850	1.590x700x854	1.350x700x850	1.342x700x850	915x700x875	915x700x895
INTERNAL CAPACITY	GN-1/1	600x400	GN-1/1 600x400	GN-1/1	GN-1/1	GN-1/1	GN-1/1
WORKTOP	Granite	Granite	Granite	Stainless steel	Stainless steel	Polyamide	Stainless steel
INGREDIENT UNIT FOR GN CONTAINERS	In option EMI / EMIT	In option EMI / EMIT	Rear unit	Rear unit	Hole in worktop	Hole in worktop	Rear unit
COOLANT	R-600a	R-290	R-290	R-290	R-290	R-290	R-290
CLIMATE CLASS	4	4	4	4	4	4	4
EVAPORATOR	INTERNAL	CENTRAL EVAPORATOR	CENTRAL EVAPORATOR	CENTRAL EVAPORATOR	CENTRAL EVAPORATOR	CENTRAL EVAPORATOR	CENTRAL EVAPORATOR
REFRIGERATION SYSTEM	Forced	Static	Forced	Forced	Forced	Forced	Forced
HACCP	NO	NO	NO	NO	NO	NO	NO
ECO MODE	YES	YES	YES	NO	NO	NO	NO
LOCK KEY	IN OPTION	IN OPTION	IN OPTION	IN OPTION	IN OPTION	NO	NO
PROTECTION GRADE	IPX4	IPX4	IPX4	IPX4	IPX4	IPX4	IPX4

Preparation counters | configurables Depth 700 /800 mm

We offer a series of tables with a granite work surface, with the option of positioning different types of cabinet with ingredients on them, to suit each need.



MODEL	COOLANT	HZ.	CODE	DOORS	ENERGY EFFICIENCY CLASS	GROSS CAPACITY (L)	ANNUAL ENERGY CONSUMPTION (KW-H)	ELECTRIC POWER (W)	DIMENSIONS (mm)	€
REFRIGERATED COUNTERS 700 mm WITH GRANITE WORKTOP										
 EMFP-135-GN GR	R-600a	50	19043010	2	B	274	752	202	1.342x700x850	-
 EMFP-180-GN GR	R-600a	50	19043035	3	C	428	931	202	1.792x700x850	-
 EMFP-225-GN GR	R-600a	50	19043048	4	C	581	1.096	224	2.242x700x850	-
REFRIGERATED COUNTERS 800 mm WITH GRANITE WORKTOP IN OPTION										
 EMPP-150-GV	R-290	50	19037745 (*)	2	-	376	-	212	1.492x800x850	-
 EMPP-202-GV	R-290	50	19037746 (*)	3	-	584	-	361	2.017x800x850	-

(*) Granite worktop not included. See options.



EMI-135



EMIT-180

Ingredient units

MODEL	FOR COUNTER:	CODE	COVER	CONTAINERS CAPACITY	ELECTRIC POWER (W)	COOLANT	DIMENSIONS (mm)	€	
GLASS COVERED CASES FOR 1/4 GN CONTAINERS									
	EMI-135	135 GN GR	19061729	Glass	5xGN 1/4	178	R-600a	1.340x336x450	-
	EMI-180	180 GN GR	19061743	Glass	8xGN 1/4	178	R-600a	1.790x336x450	-
	EMI-225	225 GN GR	19061747	Glass	10xGN 1/4	216	R-600a	2.240x336x450	-
	EMI-150	EMPP-150 GR	19061741	Glass	6xGN 1/4	178	R-600a	1.496x336x450	-
	EMI-202	EMPP-202 GR	19061745	Glass	9xGN 1/4	178	R-600a	2.019x336x450	-
CASES WITH COVER FOR 1/4 GN CONTAINERS									
	EMIT-135	135 GN GR	19061740	Stainless steel cover	5xGN 1/4	178	R-600a	1.340x336x250	-
	EMIT-180	180 GN GR	19061744	Stainless steel cover	8xGN 1/4	178	R-600a	1.790x336x250	-
	EMIT-225	225 GN GR	19061748	Stainless steel cover	10xGN 1/4	216	R-600a	2.240x336x250	-
	EMIT-150	EMPP-150 GR	19061742	Stainless steel cover	6xGN 1/4	178	R-600a	1.496x336x250	-
	EMIT-202	EMPP-202 GR	19061746	Stainless steel cover	9xGN 1/4	178	R-600a	2.019x336x250	-

Possible options. Prices increased by model

MODEL	BACK STAINLESS STEEL (€)	GRANITE 3 CM WORKTOP (€)	WITHOUT WORKTOP (€)	WITHOUT REAR GUARD (€)	SET OF CASTORS (€)	LOCK KEY (BY DOOR) (€)	KIT CAJONES		COMPRESSOR ON THE LEFT (€)	HEATED DOOR FRAME (€)	PANORAMIC OPENING (€)
							[1/2] UNIT (€)	[1/3] UNIT (€)			
EMFP-135 GN GR	0	0	-	-	-	0	0	0	0	0	0
EMFP-180 GN GR	0	0	-	-	-	0	0	0	0	0	0
EMFP-225 GN GR	0	0	-	-	-	0	0	0	0	0	0
EMPP-150 GR	0	0	-	-	-	0	-	-	-	0	0
EMPP-202 GR	0	0	-	-	-	0	-	-	-	0	0

Accessories for preparation counters (*)

FOR MODELS:	ACCESSORY	CODE
GN TABLES	RACK GN-1/1 in Epoxi (530x325)	12035781
	RACK GN-1/1 Stainless steel. (530x325)	19000999
	GUIDE for rack GN-1/1 - Wall - 562 mm - 1 piece	12037936
	GUIDE for rack GN-1/1 - Central - 612 mm - 1 piece	12036716
PASTRY TABLES	PASTRY RACK in Epoxi (600x400)	12034886
	PASTRY RACK in Stainless steel (600x400)	19001001
	PASTRY TRAY Stainless steel (600x400)	19010201
	GUIDE for pastry rack - Wall - 649 mm - 1 piece	12036419
	GUIDE for pastry rack - Central - 711 mm - 1 p.	12038109

* Check prices at accessories and spare parts list

Preparation counters | Compact professional for pizza

Depth 700 mm





Prep pizza counters include specific features according to customer's requirements. Fagor Industrial has developed a product to satisfy every customer.



EMPZ-160

General characteristics

- High quality austenitic stainless steel inside and outside (except for galvanised back panel).
- 3 cm thick granite worktop with granite sides and splashback (2 cm thick and 9 cm high).
- 50 mm, 40 kg/m³ injected polyurethane insulation.
- Forced draught cooling system inside the room.
- Copper piping and aluminium flaps evaporator.
- Digital display for electronic and digital control of temperature and defrosting.
- Opened door delay alarm.
- Easier loading and unloading thanks to its door self-closing and stay open features.
- Removable and height adjustable plastic covered steel shelves for easy cleaning.
- Equipment per door: 1 grid and 2 sets of height adjustable tray slides.
- Inner drainage to get rid of waste waters.
- Embedded bottom and curved panels inside for easy cleaning and maintenance.
- Height adjustable stainless steel legs.
- Working temperature: 0 °C, +8 °C (room temperature: 38 °C).

MODEL	HZ.	CODE	DOORS	GROSS CAPACITY (L)	ELECTRIC POWER (W)	COOLANT	DIMMENSIONS (mm)	€	
Professional COMPACT COUNTERS FOR PIZZA									
 	EMPZ-160	50	19037748	2	325	250	R-290	1.590x700x854	-
 	EMPZ-210	50	19037749	3	505	250	R-290	2.110x700x854	-

Possible options. Prices increased by model

MODEL	BACK STAINLESS STEEL (€)	GRANITE 3 CM WORKTOP (€)	WITHOUT WORKTOP (€)	WITHOUT REAR GUARD (€)	SET OF CASTORS (€)	LOCK KEY (BY DOOR) (€)	KIT DRAWERS		COMPRESSOR ON THE LEFT (€)	HEATED DOR FRAME (€)	PANORAMIC OPENING (€)
							[1/2] UNIT (€)	[1/3] UNIT (€)			
CONCEPT											
EMPZ-160	0	-	-	-	-	-	-	-	-	0	0
EMPZ-210	0	-	-	-	-	-	-	-	-	0	0

Accessories for compact counters (*)

ACCESSORY	CODE
GN-1/1 GRILL - Epoxi (530x325)	12035781
GN-1/1 GRILL - Stainless steel (530x325)	19000999
SIDE GUIDE FOR GN-1/1 GRILL - 562 mm - 1 unit	12037936
CENTRAL GUIDE FOR GN-1/1 GRILL - 612 mm - 1 unit	12036716

* Check prices at accessories and spare parts list

Preparation counters | Compact for pizza depth 700 mm

The tables for pizza come with particular characteristics which respond to the demands of this specific market category. Fagor Industrial has developed this product with the purpose of satisfying each customer.



General characteristics

- High quality austenitic stainless steel inside and outside (except for galvanised back panel).
- Built-in ingredients unit.
- 50 mm, 40 kg/m³ injected polyurethane insulation.
- Forced draught cooling system inside the room.
- Copper piping and aluminium flaps evaporator.
- Digital display for electronic and digital control of temperature and defrosting.
- Opened door delay alarm.
- Easier loading and unloading thanks to its door self-closing and stay open features.
- Removable and height adjustable plastic covered steel shelves for easy cleaning.
- Equipment per door: 1 grid and 2 sets of height adjustable tray slides.
- Inner drainage to get rid of waste waters.
- Embedded bottom and curved panels inside for easy cleaning and maintenance.
- Height adjustable stainless steel legs.
- Working temperature: +2 °C, +8 °C (room temperature: 38 °C).



EMPZ2-180

CONSERVATION:

Includes a unit for refrigerated ingredients on the surface top with capacity to house 7 and 9 GN trays with a depth of 150 mm (in table with 2 and 3 doors respectively).

MODEL	HZ.	CODE	NO. OF DOORS	GROSS CAPACITY (L)	ELECTRIC POWER (W)	COOLANT	DIMENSIONS (mm)	€
Compact COUNTERS for pizza								
	50	19069340	2	290	262	R-290	1.350x708x850	-
	60	19074201			308			
	50	19068877	3	290	522	R-290	1.800x708x850	-
	60	19074202			530			

Possible options. Prices increased by model

MODEL	BACK STAINLESS STEEL	GRANITE 3 CM WORKTOP	WITHOUT WORKTOP	WITHOUT REAR GUARD	SET OF CASTORS	LOCK KEY (BY DOOR)	KIT DRAWERS		COMPRESSOR ON THE LEFT	HEATED DOR FRAME	PANORAMIC OPENING
	RI	GR	SE	SP	R	CR	[1/2] UNIT	[1/3] UNIT			
	(€)	(€)	(€)	(€)	(€)	(€)	(€)	(€)			
CONCEPT - Mesas de preparación											
EMPZ2-135	0	-	-	-	0	0	0	0	-	0	0
EMPZ2-180	0	-	-	-	0	0	0	0	-	0	0

Accessories for compact counters (*)

ACCESSORY	CODE
GN-1/1 GRILL - Epoxi (530x325)	12035781
GN-1/1 GRILL - Stainless steel (530x325)	19000999
SIDE GUIDE FOR GN-1/1 GRILL - 562 mm - 1 unit	12037936
CENTRAL GUIDE FOR GN-1/1 GRILL - 612 mm - 1 unit	12036716
GN-1/3 INOX CONTAINER - 150 mm depth	19000682

* Check prices at accessories and spare parts list

Preparation counters | For salads and sandwiches



CONCEPT includes specially designed counters for sandwiches and salads preparation and includes specific spaces for different sizes Gastronorm containers.

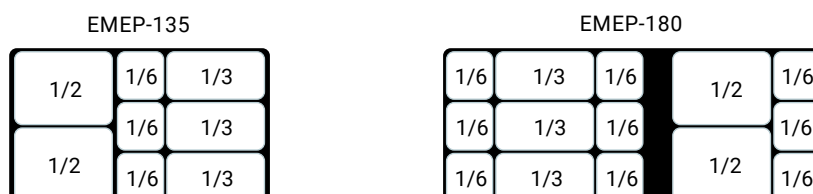

General characteristics

- High quality austenitic stainless steel inside and outside (except for galvanised back panel).
- 50 mm, 40 kg/m³ injected polyurethane insulation.
- Forced draught cooling system inside the room.
- Copper piping and aluminium flaps evaporator.
- Digital display for electronic and digital control of temperature and defrosting.
- Opened door delay alarm.
- Easier loading and unloading thanks to its door self-closing and stay open features.
- Removable and height adjustable plastic covered steel shelves for easy cleaning.
- Equipment per door: 1 grid and 2 sets of height adjustable tray slides. GN containers not included.
- Built-in drainage to get rid of waste liquids inside the unit.
- Embedded bottom and curved panels inside for easy cleaning and maintenance.
- Height adjustable stainless steel legs.
- Working temperature: 2 °C, +8 °C (room temperature: 38 °C).



MODEL	HZ.	CODE	NO. OF DOORS	GROSS CAPACITY (L)	ELECTRIC POWER (W)	COOLANT	DIMENSIONS (mm)	€
SALAD COUNTERS								
 EMEP-135-GN	50	19037762	2	274	280	R-290	1.342x700x850	-
	60	19074603			326			
 EMEP-180-GN	50	19037765	3	428	414	R-290	1.792x700x850	-
	60	19074604			520			

Possible options. Prices increased by model

MODEL	BACK STAINLESS STEEL	GRANITE 3 CM WORKTOP	WITHOUT WORKTOP	WITHOUT REAR GUARD	SET OF CASTORS	LOCK KEY (BY DOOR)	KIT DRAWERS		COMPRESSOR ON THE LEFT	HEATED DOR FRAME	PANORAMIC OPENING
							[1/2] UNIT	[1/3] UNIT			
							RI	GR			
(€)	(€)	(€)	(€)	(€)	(€)	(€)	(€)	(€)	(€)	(€)	
EMEP-135-GN	0	-	-	-	0	0	-	-	-	Std	0
EMEP-180-GN	0	-	-	-	0	0	-	-	-	Std	0

Accessories for salad counters (*)

ACCESSORY	CODE
GN-1/1 GRILL - Epoxi (530x325)	12035781
GN-1/1 GRILL - Stainless steel (530x325)	19000999
SIDE GUIDE FOR GN-1/1 GRILL - 562 mm - 1 unit	12037936
CENTRAL GUIDE FOR GN-1/1 GRILL - 612 mm - 1 unit	12036716
GN-1/1 CONTAINER - 150 mm depth	19000669

* Check prices at accessories and spare parts list

Preparation counters | Saladettes

Fagor Industrial offers two small, compact salad tables with many properties incorporated, for the smallest work spaces.



General characteristics

- High quality austenitic stainless steel inside and outside (except for galvanised back panel).
- 50 mm of injected polyurethane insulation with density of 40 kg/m³.
- Forced draught refrigeration system located inside the chamber.
- Evaporator with copper tube and aluminium cooling fins.
- Electronic and digital control of temperature and of defrosting with digital display.
- Alarm to avoid prolonged door opening.
- Automatic door closure and blocking mechanism, which makes loading and unloading the appliance more convenient.
- Plastified steel shelves, easily removable for cleaning, with height-adjustable guides.
- Equipment included per door: 1 rack and 2 sets of guides for positioning at different heights.
- Interior drain which allows the drainage of waste waters.
- Inbuilt floor and curved interiors to facilitate cleaning and conservation.
- Height-adjustable stainless steel feet
- Operational temperature: +2 °C, +8 °C (ambient 38 °C).



EMEP-100

Example of distribution a

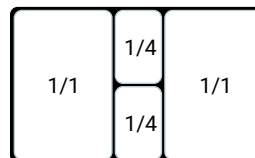

Example of distribution b

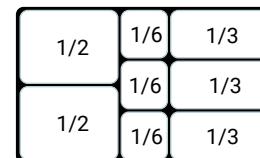

EMEP-100 G



Display

Cristal cover with containers unit for 1/6 GN containers, 100 mm depth.

Granite 3 Cm Worktop:

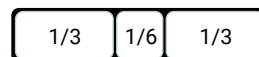

Cooling units underneath allow for a shorter length.

Example of distribution a

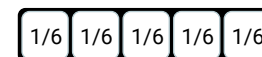

Example of distribution b



MODEL	HZ.	CODE	NO. OF DOORS	GROSS CAPACITY (L)	ELECTRIC POWER (W)	COOLANT	DIMENSIONS (mm)	€
SALADETTE - SANDWICHES AND SALADS								
 EMEP-100	50	19037766	2	177	254	R-290	915x700x875	-
	60	19074203			300			
SALADETTE - PIZZA								
 EMEP-100 G GR	50	19037768	2	177	254	R-290	915x700x895	-
	60	19074605			300			

Possible options. Prices increased by model

MODEL	BACK STAINLESS STEEL	GRANITE 3 CM WORKTOP	WITHOUT WORKTOP	WITHOUT REAR GUARD	SET OF CASTORS	LOCK KEY (BY DOOR)	KIT DRAWERS		COMPRESSOR ON THE LEFT	HEATED DOR FRAME	PANORAMIC OPENING
							[1/2] UNIT	[1/3] UNIT			
							H	T			
	RI	GR	SE	SP	R	CR	H	T	GI	T	AP
	(€)	(€)	(€)	(€)	(€)	(€)	(€)	(€)	(€)	(€)	(€)
EMEP-100 / 100G	0	-	-	-	0	-	-	-	-	0	0

Accessories for saladettes (*)

ACCESSORY	CODE
GN-1/1 GRILL - Epoxi (530x325)	12035781
GN-1/1 GRILL - Stainless steel (530x325)	19000999
SIDE GUIDE FOR GN-1/1 GRILL - 562 mm - 1 unit	12037936
CENTRAL GUIDE FOR GN-1/1 GRILL - 612 mm - 1 unit	12036716
GN-1/1 CONTAINER - 100 mm depth	19000668

* Check prices at accessories and spare parts list



Compact and reliable
components ideal for
storing bottles.



Find out more!



Access the website

Bottle coolers

Back bar counters	233
Non refrigerated back bar counters	237
Back bar coolers.....	239
Top-load bottle coolers.....	243
Professional refrigeration cabinets.....	245
Glass frosters	249

Special units or any variations on the standard model must be assembled at the factory at an additional charge over the standard model's price.

Please, contact Fagor Industrial for any other variation or option that is not included on this list.

Back bar counters



With all the features of the refrigerated counters of the Snack range

General characteristics

Rear guard of 10 cm / Right side cooling unit with pivoting grille door.

Internal shelves of plastic-coated steel, adjustable in height.

Equipment: 2 grids per door.

Neutral drawer over refrigeration unit.

R-600a ecological coolant, CFC free.

Copper pipe evaporator with aluminium wings. Forced draught.

Automatic evaporation of defrosting water.

Climatic class: 4.

Working temperature -2 °C, +8 °C, at room temperature of 43 °C (*)

Electronic temperature and defrosting control, and display.

HEIGHT:

Counter units are 1045 mm tall. This height makes them ideal to combine with our coffee counters and shelves.

(*) AMBIENT TEMPERATURE: Guaranteed operation at 43°C. Excluded display models with glass doors. For specific intensive usage please check with Fagor Commercial Manager.

Back bar counters



EMFP-202

Neutral drawer over refrigeration unit.

Back bar counters With glass doors



EFMP-202-PC

Glass doors with vacuum chamber / LED lighting
/ Lock standard with glass doors

	MODEL	COOLANT	HZ.	CODE	NO. OF DOORS	ENERGY EFFICIENCY CLASS	GROSS CAPACITY (L)	ANNUAL ENERGY CONSUMPTION (KW-H)	ELECTRIC POWER (W)	DIMENSIONS (mm)	€
Refrigerated FRONT counters											
	 EFMP-150	R-600a	50	19036966	2	C	355	835	202	1.492x600x1.045	-
	 EFMP-202	R-600a	50	19036968	3	C		988	202	2.017x600x1.045	-
	 EFMP-255	R-600a	50	19037010	4	C	747	1.171	224	2.542x600x1.045	-
Refrigerated FRONT counters with glass doors											
	 EFMP-150CRPC	R-600a	50	19036967	2	-	355	-	202	1.492x600x1.045	-
	 EFMP-202CRPC	R-600a	50	19036969	3	-	551	-	209	2.017x600x1.045	-
	 EFMP-255CRPC	R-600a	50	19037011	4	-	747	-	234	2.542x600x1.045	-

Remote back bar counters

Remote back bar counters With pre-installation*









EFMP-117

Remote back bar counters With glass doors and pre-installation*





EFMP-169-CR PC

(*) Cooling unit not included /
Control panel with electronic thermostat / Start switch.

	MODEL	HZ.	CODE	NO. OF DOORS	ENERGY EFFICIENCY CLASS	GROSS CAPACITY (L)	ANNUAL ENERGY CONSUMPTION (KW-H)	ELECTRIC POWER (W)	COOLANT	DIMENSIONS (mm)	€
Refrigerated back bar counters with pre-installation											
	EFMP-117-R	50/60	19037657	2	-	355	-	-	-	1.192x600x1.045	-
	EFMP-169-R	50/60	19037659	3	-	551	-	-	-	1.717x600x1.045	-
	EFMP-222-R	50/60	19037661	4	-	747	-	-	-	2.242x600x1.045	-
Refrigerated back bar counters with glass doors and pre-installation											
	EFMP-117-R CR PC	50/60	19037662	2	-	355	-	-	-	1.192x600x1.045	-
	EFMP-169-R CR PC	50/60	19037664	3	-	551	-	-	-	1.717x600x1.045	-
	EFMP-222-R CR PC	50/60	19037665	4	-	747	-	-	-	2.242x600x1.045	-

Drawers for back bar counters

KIT MODEL	CODE	COUNTER TYPE	POSITION OF THE KIT IN THE UNIT	€
 KIT 2 DRAWERS (1/2+2/3)	19004924	EFMP		-

Available options and price increase per model

MODEL	STAINLESS STEEL BACK PANEL	WITHOUT WORKTOP	WITHOUT SPLASHBACK	WHEELS SET	LOCK (PER DOOR)	DRAWERS SET [1/3 + 2/3] UNIT	HOPPER (#)	COMPRESSOR ON THE LEFT	HEATED DOR FRAME
	RI (€)	SE (€)	SP (€)	R (€)	CR (€)	H (€)	TV (€)	GI (€)	T (€)
EFMP-150	0	0	0	0	0	0	0	0	0
EFMP-202	0	0	0	0	0	0	0	0	0
EFMP-255	0	0	0	0	0	0	0	0	0
EFMP-150-CR PC	0	0	0	0	Std	-	0	0	0
EFMP-202-CR PC	0	0	0	0	Std	-	0	0	0
EFMP-255-CR PC	0	0	0	0	Std	-	0	0	0
EFMP-117-R	0	0	0	-	0	-	-	-	0
EFMP-169-R	0	0	0	-	0	-	-	-	0
EFMP-222-R	0	0	0	-	0	-	-	-	0
EFMP-117-R-CR PC	0	0	0	-	Std	-	-	-	0
EFMP-169-R-CR PC	0	0	0	-	Std	-	-	-	0
EFMP-222-R-CR PC	0	0	0	-	Std	-	-	-	0

Replaces the neutral drawer

Possible options. Prices increased by model (*)

DESCRIPTION	CODE
Side grill in Epoxi(405x460)	12034975
Central grill in Epoxi (405x525)	12034847
Snack rack support	12037728

* Check prices at accessories and spare parts list

Non-refrigerated back bar counters



MODELOS MMC



MODELOS MME

General characteristics

- Built with high quality austenitic stainless steel.
- Worktop with 10 cm high splashback.
- Height adjustable stainless steel legs.
- Rounded edges.



MMC models

- Match perfectly with counter fronts and 60 series shelves.
- The basic models include one shelf, but more shelves can be added.
- Stainless steel drawers on ball bearing tray slides.
- Removable waste collecting stainless steel hopper.
- Versions with hole in the worktop to pass the connections of the coffee machine.

MME models

- 600 mm models can fit non-refrigerated drawers.
- Some models have 1 or 2 intermediate shelves.

Coffee non-refrigerated units

MODEL	CODE	NO. OF SHELVES	NO. OF DRAWERS	MODULE POSITION	WORKTOP HOLE	DIMENSIONS (mm)	€
 MMC-100	19006486	1	1	Right	-	990x600x1.045	-
	19010481	1	1	Right	Yes	990x600x1.045	-
MMC-100 I	19006489	1	1	Left	-	990x600x1.045	-
	19010106	1	1	Left	Yes	990x600x1.045	-
 MMC-150	19006777	1	2	Central	-	1.500x600x1.045	-
	19006781	1	2	Central	Yes	1.500x600x1.045	-
MMC-200	19007146	1	2	Central	-	2.025x600x1.045	-
	19007148	1	2	Central	Yes	2.025x600x1.045	-
MMC-250	19007420	1	2	Central	-	2.550x600x1.045	-
	19011375	1	2	Central	Yes	2.550x600x1.045	-
ACCESSORIES (OPTIONAL SHELVES)							
EMMC-100	19005429	For MMC-100 and MMC-150 coffee units	-	-	-	-	-
EMMC-200	19006226	For MMC-200 coffee unit	-	-	-	-	-
EMMC-250	19006225	For MMC-250 coffee unit	-	-	-	-	-

Non-refrigerated front counter shelves

MODEL	CODE	NO. OF SHELVES	DIMENSIONS (mm)	€
MME-35/100	19005427	1	990x350x1.045	-
MME-35/100 2E	19005446	2	990x350x1.045	-
MME-35/150	19005723	1	1.500x350x1.045	-
MME-35/150 2E	19005781	2	1.500x350x1.045	-
MME-35/200	19006223	1	2.025x350x1.045	-
MME-35/200 2E	19006245	2	2.025x350x1.045	-
MME-35/250	19006448	1	2.550x350x1.045	-
MME-35/250 2E	19006471	2	2.550x350x1.045	-
MME-60/100	19005746	1	990x600x1.045	-
MME-60/100 2E	19005784	2	990x600x1.045	-
MME-60/150	19006473	1	1.500x600x1.045	-
MME-60/150 2E	19006480	2	1.500x600x1.045	-
MME-60/200	19007015	1	2.025x600x1.045	-
MME-60/200 2E	19007054	2	2.025x600x1.045	-
MME-60/250	19007282	1	2.550x600x1.045	-
MME-60/250 2E	19007351	2	2.550x600x1.045	-

Back bar coolers

New range of bar back coolers with a modern and elegant design that offers several options and finishes to suit your business's different needs.



EBBC series

General characteristics

- High quality matte austenitic stainless steel inside and black plastic covered galvanised steel outside (galvanised back panel).
- 40 kg/m³ injected polyurethane insulation and reinforced worktop.
- Removable cassette type forced draught cooling system for quick replacement.
- Optimised air circulation system for larger storage capacity.
- Copper piping and aluminium flaps evaporator.
- Digital display for electronic control of temperature.
- Double glazed doors and anodised aluminium frame with stainless steel finish.
- The standard equipment includes a plastic covered shelf per door.
- LED lighting system.
- Working temperature: +2 °C, +8 °C (room temperature: 32 °C).
- Lock at the door's upper section.



MODEL	COOLANT	HZ.	CODE	NO. OF DOORS	GROSS CAPACITY (L)	BOTTLES CAPACITY (75CL)	ELECTRIC POWER (W)	DIMENSIONS (mm)	€
EBBC2	R-290	50	19037810	2	300	200	238	1.544x535x860	-
EBBC3	R-290	50	19037744	3	510	290	241	2.105x535x860	-

Back bar coolers

ERM series



General characteristics

- Sanitary epoxy coated galvanised steel inside.
- Two outside finish options: either satin stainless steel (Inox version) or black plastic covered galvanised steel (black version).
- 40 kg/m³ injected polyurethane insulation.
- Copper piping and aluminium flaps evaporator.
- Hermetically sealed copper serpentine ventilated compressor.
- Double glazed doors with anti-mist protection (low E) with inner air chamber and handle.
- Fitted with a lock.
- Digital display for electronic control of temperature.
- ON/OFF power switch.
- Vertical led lighting located in the frame.
- Fitted with two plastic covered steel grid shelves.
- Working temperature: +2 °C, +8 °C (room temperature: 32 °C).



EERM-150 INOX



EERM-250

	MODEL	COOLANT	HZ.	CODE	NO. OF DOORS	GROSS CAPACITY (L)	BOTTLES CAPACITY (75CL)	ELECTRIC POWER (W)	DIMENSIONS (mm)	€
Refrigerated wall displays ERM SERIES (exterior in stainless steel)										
	EERM-150 SS	R-600a	50	19048035	1	142	49	160	625x565x900	-
	EERM-250 SS	R-600a	50	19048036	2	214	77	160	925x565x900	-
	EERM-350 SS	R-600a	50	19048037	3	327	119	160	1.375x565x900	-
Refrigerated wall displays ERM SERIES (black plastic covered)										
	EERM-150	R-600a	50	19048033	1	142	49	160	625x565x900	-
	EERM-250	R-600a	50	19046985	2	214	77	160	925x565x900	-
	EERM-350	R-600a	50	19048034	3	327	119	160	1.375x565x900	-
HEIGHT 800 mm - UNDERCOUNTER										
Refrigerated wall displays ERMU SERIES (exterior in stainless steel)										
	EERMU-150 SS	R-600a	50	19048291	1	121	49	160	625x565x800	-
	EERMU-250 SS	R-600a	50	19048292	2	182	77	160	925x565x800	-
	EERMU-350 SS	R-600a	50	19048293	3	277	119	160	1.375x565x800	-
Refrigerated wall displays ERMU SERIES (black plastic covered)										
	EERMU-150	R-600a	50	19048288	1	121	49	160	625x565x800	-
	EERMU-250	R-600a	50	19048289	2	182	77	160	925x565x800	-
	EERMU-350	R-600a	50	19048290	3	277	119	160	1.375x565x800	-







Top load bottle coolers

Our experience as manufacturers of bottle coolers ensures a top quality and reliable product. Designed for optimal storage of bottles at any business.







Stainless steel series | General characteristics

- Outside and inner sides made of high quality austenitic stainless steel.
- 40 kg/m³ injected polyurethane insulation.
- Hermetically sealed ventilated compressor at the bottom of the equipment.
- Static copper piping and aluminium flaps evaporator.
- Analogical thermostat for temperature control.
- Sliding doors with built-in handles.
- Height adjustable stainless steel legs.
- Right side cooling unit with grilled door.
- Fitted with vertical dividers made of plastic covered steel grid.
- Waste water drainage and curved joints between inner panels for easy cleaning.
- Working temperature: +2 °C, +6 °C (room temperature: 38 °C).
- Optional: Evaporator drain tray.

	MODEL	COOLANTE	HZ.	CODE	NO. OF DOORS	NO OF SEPARATOR GRIDS	GROSS CAPACITY (L)	ELECTRIC POWER (W)	DIMENSIONS (mm)	€
	 EBFP-100 I	R-600a	50	19048052	2	1	223	109	1.010x552x850	-
	 EBFP-150 I	R-600a	50	19048054	3	2	381	205	1.500x552x850	-
	 EBFP-200 I	R-600a	50	19048061	4	3	539	205	1.990x552x850	-
	 EBFP-250 I	R-600a	50	19048088	5	4	696	205	2.480x552x850	-

Skin plate series | General characteristics

- White plastic covered stainless steel outside finish and galvanised steel inside finish.
- 40 kg/m³ injected polyurethane insulation.
- Hermetically sealed compressor with ventilated condenser.
- Static copper piping and aluminium flaps evaporator.
- Analogical thermostat for temperature control.
- Sliding doors with built in handles.
- Height adjustable stainless steel legs.
- Inner cooling unit.
- Fitted with vertical dividers made of plastic covered steel grid.
- Waste water drainage and curved joints between inner panels for easy cleaning.
- Working temperature: +2 °C, +6 °C (room temperature: 32 °C).

	MODEL	CODE	NO. OF DOORS	NO OF SEPARATOR GRIDS	GROSS CAPACITY (L)	ELECTRIC POWER (W)	COOLANT	DIMENSIONS (mm)	€
	 BEG-100	19010156	2	1	137	150	R600a	1.017x545x840	-
	 BEG-150	19010149	3	2	230	165	R600a	1.510x545x840	-
	 BEG-200	19010150	4	3	314	190	R600a	2.023x545x840	-

Professional refrigeration cabinets

We present the new range of professional refrigeration cabinets, with large capacity and different external finishes to best meet your business needs.



General characteristics

- Stainless steel external case.
- Inner body in food-standard ABS material.
- Interior corners and edges rounded to facilitate cleaning.
- Door with handle incorporated.
- Reversible door.
- Equipped with lock and key as standard.
- Digital thermometer with temperature control.
- Operational voltage: 230 V - 50 Hz.

Refrigerated cabinets:

- Supplied with 3 upper racks and 1 rack for the lower space (model AFP-251-I, 2 upper racks).
- Guides inbuilt into the sides of the cabinet with anti-tip system.
- Drain inside the chamber.
- Forced refrigeration. Evaporator integrated into the back wall of the cabinet. A fan distributes the cold, obtaining a uniform temperature inside.
- R-600a hydrocarbon refrigerant gas.

- Operational temperature: $-1\text{ }^{\circ}\text{C} \div +6\text{ }^{\circ}\text{C}$, Ambient temperature $32\text{ }^{\circ}\text{C}$.

Frozen product maintenance cabinets:

- Equipped with 6 fixed shelves (model AFN-251-I, 2 shelves).
- Static refrigeration by means of evaporator shelves.
- R-290 hydrocarbon refrigerant gas.
- Operational temperature: $-22\text{ }^{\circ}\text{C} \div -15\text{ }^{\circ}\text{C}$. Ambient temperature $32\text{ }^{\circ}\text{C}$.

Stainless steel series









AFP-251-I



AFP-451-I



AFP-651-I

MODEL	REFRIGERANT	HZ.	CODE	VOLUME (L)	SHELVES	CLIMATE CLASS	ENERGY EFFICIENCY CLASS	ELECTRICAL POWER (W)	DIMENSIONS (mm)	€
PROFESSIONAL REFRIGERATED CABINETS										
 AFP-251-I	R-600a	50	19059667	125	2	4	B	91	626 x 600 x 850	-
 AFP-451-I	R-600a	50	19059665	460	3+1	4	D	186	626 x 740 x 1,865	-
 AFP-651-I	R-600a	50	19059666	600	3 (GN-2/1) +1	4	D	186	780 x 740 x 1,865	-
PROFESSIONAL FREEZER MAINTENANCE CABINETS										
 AFN-251-I	R-290	50	19059677	125	2	4	-	142	626 x 600 x 850	-
 AFN-451-I	R-290	50	19059675	460	6	4	-	143	626 x 740 x 1,865	-
 AFN-651-I	R-290	50	19059676	600	6	4	-	145	780 x 740 x 1,865	-

Epoxy series



AFP-251



AFP-451



AFP-651

General characteristics

- Steel sheet exterior with white epoxy coating that provides high resistance to impacts and daily use.
- Inner body in food-standard ABS material.
- Interior corners and edges rounded to facilitate cleaning.
- Door with handle incorporated.
- Reversible door.
- Equipped with lock and key as standard.
- Digital thermometer with temperature control.
- Operational voltage: 230 V - 50 Hz.

Refrigerated cabinets:

- Supplied with 3 upper racks and 1 rack for the lower space (model AFP-251, 2 upper racks).
- Guides inbuilt into the sides of the cabinet with anti-tip system.
- Drain inside the chamber.
- Forced refrigeration. Evaporator integrated into the back wall of the cabinet. A fan distributes the cold, obtaining a uniform temperature inside.
- R-600a hydrocarbon refrigerant gas.
- Operational temperature: $-1\text{ }^{\circ}\text{C} \div +6\text{ }^{\circ}\text{C}$, Ambient temperature $32\text{ }^{\circ}\text{C}$.

Frozen product maintenance cabinets:

- Equipped with 7 fixed shelves (model AFN-251, 2 shelves).
- Static refrigeration by means of evaporator shelves.
- R-290 hydrocarbon refrigerant gas.
- Operational temperature: $-22\text{ }^{\circ}\text{C} \div -15\text{ }^{\circ}\text{C}$. Ambient temperature $32\text{ }^{\circ}\text{C}$.

	MODEL	REFRIGERANT	HZ.	CODE	VOLUME (L)	SHELVES	CLIMATE CLASS	ENERGY EFFICIENCY CLASS	ELECTRICAL POWER (W)	DIMENSIONS (mm)	€
PROFESSIONAL REFRIGERATED CABINETS											
	AFP-251	R-600a	50	19059664	125	2	4	B	91	626 x 600 x 850	-
	AFP-451	R-600a	50	19059662	460	3+1	4	D	186	626 x 742 x 1,865	-
	AFP-651	R-600a	50	19059663	600	3 (GN-2/1) + 1	4	D	186	780 x 742 x 1,865	-
PROFESSIONAL FREEZER MAINTENANCE CABINETS											
	AFN-251	R-290	50	19059674	125	2	4	-	142	626 x 600 x 850	-
	AFN-451	R-290	50	19059672	460	7	4	-	143	626 x 742 x 1,865	-
	AFN-651	R-290	50	19059673	600	7	4	-	145	780 x 742 x 1,865	-

Display cabinets



AEP-251





AEP-451



AEP-651

General characteristics

- Steel sheet exterior with white epoxy coating that provides high resistance to impacts and daily use.
- Inner body in food-standard ABS material.
- Interior corners and edges rounded to facilitate cleaning.
- Equipped with inner fluorescent lighting to help display and draw attention to your products.
- Double glazed door with handle incorporated into the frame
- Reversible door with frame manufactured in aluminium, providing it with an elegant and very aesthetically pleasing finish.
- Equipped with lock and key as standard.
- Digital thermometer with temperature control.
- Operational voltage: 230 V - 50 Hz.
- Supplied with 3 upper racks and 1 rack for the lower space (AEP-251 model, 2 upper racks).
- Guides inbuilt into the sides of the cabinet with anti-tip system.
- Drain inside the chamber.
- Forced refrigeration. Evaporator integrated into the back wall of the cabinet. A fan distributes the cold, obtaining a uniform temperature inside.
- R-600a hydrocarbon refrigerant gas.
- Operational temperature: -1 °C ÷ +6 °C, Ambient temperature 32 °C.

MODEL	REFRIGERANT	HZ.	CODE	VOLUME (L)	SHELVES	CLIMATE CLASS	ELECTRICAL POWER (W)	DIMENSIONS (mm)	€
PROFESSIONAL DISPLAY REFRIGERATED CABINETS									
 AEP-251	R-600a	50	19059671	125	2	4	91	626 x 600 x 850	-
 AEP-451	R-600a	50	19059668	460	3+1	4	193	626 x 742 x 1.865	-
 AEP-651	R-600a	50	19059670	600	3 (GN-2/1) + 1	4	193	780 x 742 x 1.865	-

Glass frosters

Glass frosters are an ideal complement for bars and cafés when drinks are to be served at their best. Thanks to their compact size, they are perfect for reduced size businesses.



General characteristics

- High quality austenitic stainless steel inside.
- Static refrigeration systems with ventilated condenser.
- Digital temperature control and manual defrosting.
- Triple glazed doors with anti-mist system that allows viewing the defrosting process.
- Aluminium door frame to ensure optimum resistance.
- Equipment includes removable shelf for easy cleaning.
- LED lighting system.
- Working temperature: -18 °C, -12 °C (room temperature: 32 °C).

MODEL	CODE	NO. OF DOORS	T° RANK	CAPACITY (L)	ELECTRICITY CONSUMPTION (W)	COOLANT	DIMENSIONS (mm)	€
 EC-45	19036349	1	-18 °C / -12 °C	52,5	265	R-290	558x316x763	-





Showcases

Snack Showcases	253
Sushi Showcases	255
Refrigerated cases for ingredients.....	256

Special units or any variations on the standard model must be assembled at the factory at an additional charge over the standard model's price.

Please, contact Fagor Industrial for any other variation or option that is not included on this list.

Snack showcase

Some products require specific care for their conservation and presentation. Fagor Industrial offers specifically designed display cases for those products.



General characteristics









- High quality austenitic stainless steel inner tray.
- Anodised aluminium outside panels. Glass with PVC on the sides.
- Curved glass cover (one piece) or flat cover (two pieces) and glass sliding doors.
- 40 kg/m³ injected polyurethane insulation. CFC free.
- It can fit GN -1/3, 40 mm deep containers. (NOT included in neutral models)
- Lighted power switch.
Only refrigerated models:
 - Cold plate with copper tube evaporator.
 - Emergency waste water drainage.
- Electronic thermostat for temperature control.
- Shielded inner lighting system.
- Working temperature: +4 °C, +8 °C (room temperature: 32 °C).
- The containers are included in the standard equipment.



NP



NC

	MODEL	COOLANT	CODE	GLASS TYPE	CONTAINERS CAPACITY	COOLING UNIT TYPE	ELECTRIC POWER (W)	DIMENSIONS (MM)	€
Refrigerated flat glass									
	EVTP-139 P	R-600a	19048039	Plano	6*GN	Interior	82	1.380x415x278	-
	EVTP-175 P	R-600a	19048042	Plano	8*GN	Interior	82	1.732x415x278	-
Refrigerated curved glass									
	EVTP-139 C	R-600a	19048038	Curvo	6*GN	Interior	82	1.380x415x278	-
	EVTP-175 C	R-600a	19048041	Curvo	8*GN	Interior	82	1.732x415x278	-
Neutral flat glass									
	EVTP-139 NP	-	19078812	Plano	7*GN	No	-	1.380x415x278	-
	EVTP-175 NP	-	19078815	Plano	9*GN	No	-	1.732x415x278	-
Neutral curved glass									
	EVTP-139 NC	-	19078813	Curvo	7*GN	No	-	1.380x415x278	-
	EVTP-175 NC	-	19078816	Curvo	9*GN	No	-	1.732x415x278	-

New

New

Sushi showcase



General characteristics

- Perforated stainless steel inner tray for food.
- Anodised aluminium outside panels. Glass with PVC on the sides.
- Curved glass cover and glass sliding doors.
- 40 kg/m³ injected polyurethane insulation. CFC free.
- Static cooling system.
- Double built-in evaporation system by means of bottom tray and a copper pipe on the surface of the curved glass cover.
- Emergency waste water drainage.
- Electronic thermostat for temperature control.
- Shielded inner lighting system.
- Lighted power switch.
- Working temperature: -1 °C, +2 °C (room temperature: 27 °C).

MODEL	COOLANT	CODE	GLASS TYPE	COOLING UNIT TYPE	ELECTRIC POWER (W)	DIMENSIONS (MM)	€
<i>Open</i> EVTP-139 C - SUSHI	R-600a	19048040	Bended	Built-in	82	1.380x415x278	-
<i>Open</i> EVTP-175 C - SUSHI	R-600a	19048043	Bended	Built-in	82	1.732x415x278	-

Refrigerated cases for ingredients





Ingredient cases have their own cooling units to provide total location flexibility. They are the ideal complement to turn a refrigerated counter into a complete working station for the preparation of cold dishes, pizzas or sandwiches.







General characteristics

- It can fit GN 1/4, 150 mm deep containers. Containers are not included in the standard equipment.
- Cooling unit included.
- R-600a ecological cooling.
- Cold plate refrigeration system.
- Thermostatic control of temperature (+2 °C, +8 °C). Digital display.

Glass covered cases for GN-1/4 containers

	MODEL	CODE	COVER	CONTAINERS CAPACITY	ELECTRIC POWER (W)	COOLANT	DIMENSIONS (MM)	€
	EMI-135	19061729	Glass	5*GN 1/4	178	R-600a	1.340x336x450	-
	EMI-150	19061741	Glass	6*GN 1/4	178	R-600a	1.496x336x450	-
	EMI-180	19061743	Glass	8*GN 1/4	178	R-600a	1.790x336x450	-
	EMI-202	19061745	Glass	9*GN 1/4	178	R-600a	2.019x336x450	-
	EMI-225	19061747	Glass	10*GN 1/4	216	R-600a	2.240x336x450	-

Cases for stainless steel GN-1/4 containers with cover

	MODEL	CODE	COVER	CONTAINERS CAPACITY	ELECTRIC POWER (W)	COOLANT	DIMENSIONS (MM)	€
	MIT-135	19061740	Stainless steel	5*GN 1/4	178	R-600a	1.340x336x250	-
	MIT-150	19061742	Stainless steel	6*GN 1/4	178	R-600a	1.496x336x250	-
	MIT-180	19061744	Stainless steel	8*GN 1/4	178	R-600a	1.790x336x250	-
	MIT-202	19061746	Stainless steel	9*GN 1/4	178	R-600a	2.019x336x250	-
	MIT-225	19061748	Stainless steel	10*GN 1/4	216	R-600a	2.240x336x250	-



Blast chillers

ATM Series blast chillers	261
ECO Series blast chillers	263
Roll in blast chillers	265

Special units or any variations on the standard model must be assembled at the factory at an additional charge over the standard model's price.

Please, contact Fagor Industrial for any other variation or option that is not included on this list.

Why using blast chillers is important.

Blast chillers are equipment units designed to lower food temperature quickly. Food can go from cooking temperature at 90 °C to a mere 3 °C in no more than 90 minutes. This stops bacteria from growing.

Our range of mixed blast chillers can make temperature drop to -18 °C in just 4 hours. This high-speed freezing of food stops bacterial growth and prevents the appearance of macro crystal structures.



Safe, effective and respectful chilling with your food.



Find out more!



Access the website

Chilling process

The combination of combi ovens and blast chillers is highly efficient and makes planning jobs in the kitchen easier.

The correct use of blast chillers and mixed ovens results in reduction of waste, time saving and a product that can be served right away.

Blast chilling

SOFT CYCLE (STANDARD) - 90'

The right cycle for small size, light, fine food.

STRONG CYCLE (INTENSIVE) - 90'

Recommended for high density or large size food, as well as for packed food.

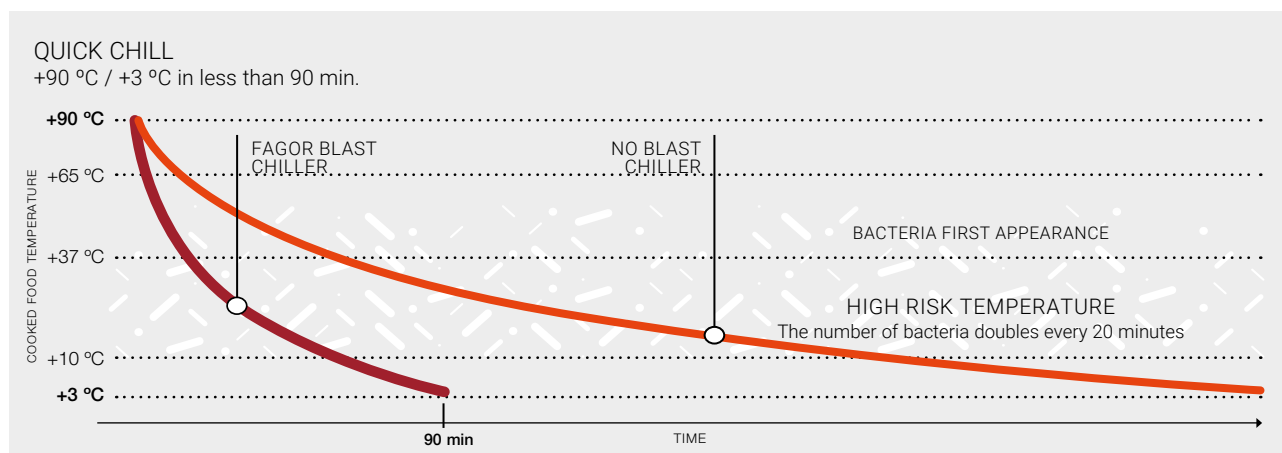

Blast freezing

SOFT CYCLE (STANDARD) - 240'

This is a cycle to freeze food with an even temperature and is therefore suitable for food that is to be cooled consistently and without sharp temperature changes or when cooked with different ingredients.

STRONG CYCLE (INTENSIVE) - 240'

This is the ideal cycle to freeze half cooked food or semi-prepared dishes. It is also suitable for raw food. It allows you to keep frozen food for a long time.

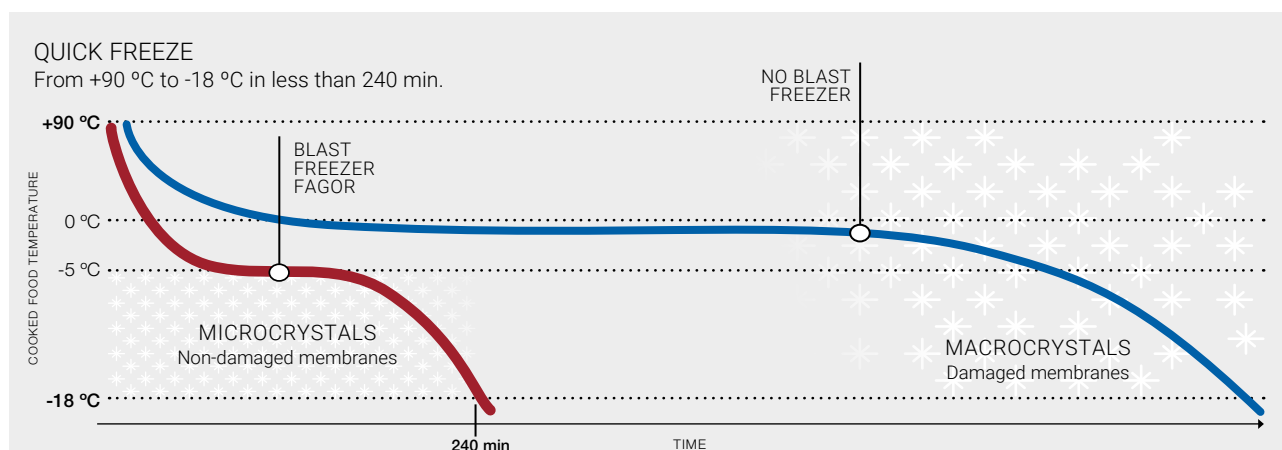

CONCEPT+ | Blast chillers and freezers

Our CONCEPT+ blast chillers and freezers come in different sizes to suit every user's needs. All of them, from the small counter top blast chillers to the large size freezers with capacity for GN2/1 trays, are fitted with an electronic control system entirely developed by Fagor Industrial R & D & i.













General characteristics

- Mixed models, for chiller blasting (+2 °C) or freezing cycles (-18 °C).
- There two working options both for chiller blasting and freezing:
- Power cycle: for over 2 cm thick compact products.
- Soft cycle: for less than 2 cm thick or low density products. The cycle is run in two programmed stages. The soft cycle prevents frost on the product.
- Cycle duration:
 - Refrigerating cycle: 90 minutes.
 - Freezing cycle: 240 minutes.
- Control panel with touch screen.
- Electronic programming of the cycles and core probe.
- The cycles can be controlled by time or by temperature according to the reading of the temperature sensor inside the product (time control is automatically applied when no probe is used).
- When the refrigerating cycle is over, the equipment works as a refrigerated cabinet, and the temperature remains between +2 and +4 °C, or as a freezer, with temperatures under -18 °C.
- Hermetically sealed compressor with ventilated condenser.
- R-452A ecological cooling (CFC free).
- EATM-031 model with R-290 coolant
- 60 mm injected polyurethane insulation (except for the 031 models, with 35 mm thick insulation). 40 kg/m³ density. CFC free.
- Copper piping and aluminium flaps evaporator.
- Forced draught cooling system.
- Automatic defrosting device activated by the user. Water evaporation device without power consumption.
- Inner tray slides included.
- Ordering options:
 - Heated probe.
 - HACCP printer (model 031 in all its versions excluded)
 - USB connection for data extraction.
 - Castor kit (factory assembly).

Concept+



MODEL	COOLANT	HZ.	CODE	LEVELS			PRODUCTION (KG/CYCLE) *		TENSION	POWER (W)		DIMENSIONS (MM)	€
				GN-1/1	GN-2/1	60X40	REFRIG.	FREEZING		ELECTRIC	COOLING		
EATM-031	R-290	50	19047207	3	-	-	12	6	230V-1N	365	365	590x700x520	-
  ATM-031 CD	R-452A	50	19056795	3	-	-	15	6	230V-1N	590	490	560x700x514	-
		60	19059645										
  ATM-051 CD	R-452A	50	19056793	5	-	5	23	13	230V-1N	1.200	690	790x700x850	-
		60	19059646										
 ATM-081 CD	R-452A	50	19056796	8	-	8	40	24	230V-1N	2.000	1.300	790x800x1.290	-
		60	19059647										
  ATM-101 CD	R-452A	50	19056797	10	-	10	50	30	230V-1N	2.000	1.300	790x800x1.420	-
		60	19059648										
 ATM-121 CD	R-452A	50	19056825	12	-	12	60	40	230V-1N	2.000	1.300	790x800x1.600	-
		60	19059649										
 ATM-161 CD	R-452A	50	19056827	16	-	16	80	50	400V-3N	3.500	2.850	790x800x1.950	-
		60	19059691										
 ATM-102 CD	R-452A	50	19056839	20	10	20	100	65	400V-3N	-	-	1.200x1.090x1.766	-
		60	19059692										

(*) Productions calculated in accordance with EN 17032

Options - factory fitted

DESCRIPTION	€
Heated probe	-
HACCP printer	-
USB connection for data extraction	-
Castor kit (factory assembly).	-

CONCEPT | Blast chillers and freezers

As a response to market requirements, we have simplified our blast chillers and freezers produced an economic CONCEPT range. This allows us to offer this essential technology as a key factor for the right management of all kinds of businesses.











General characteristics

- Satin finish stainless steel outside except for back panel (plastic covered).
- AISI-304 18/10 stainless steel inside.
- Fully injected compact structure.
- AISI-304 18/10 stainless steel tray slides included.
- 60 mm injected polyurethane insulation. 40 kg/m³ density. CFC free.
- Hermetically sealed compressor with ventilated condenser.
- Control panel with touch screen.
- R-452A ecological cooling (CFC free).
- ECO type, user friendly control panel.
- Thermostat control cycles with end of cycle acoustic alarm.
- The cycles can be controlled by time or by temperature according to the reading of the temperature sensor inside the product (time control is automatically applied when no probe is used).
- When the refrigerating cycle is over, the equipment works as a refrigerated cabinet, and the temperature remains between +2 and +4 °C, or as a freezer, with temperatures under -18 °C.
- Fitted with non-heated temperature probe.
- Automatic defrosting device activated by the user. Water evaporation device without power consumption.
- Castor kit (factory assembly).

Concept



The electronic control allows refrigeration (+3 °C) or freezing (-18 °C) cycles.

	MODEL	HZ.	CODE	LEVELS			PRODUCTION (KG/CYCLE)*		TENSION	POWER (W)		DIMENSIONS (MM)	€
				GN-1/1	GN-2/1	60X40	REFRIG.	FREEZING		ELECTRIC	COOLING		
		50	19036020	3	-	-	15	6	230V-1N	590	490	560x700x514	-
		60	19036042										
		50	19036021	5	-	5	18	10	230V-1N	1.100	650	790x700x850	-
		60	19036043										
		50	19048325	8	-	8	40	24	230V-1N	2.000	1.300	790x800x1.290	-
		60	19048720										
		50	19048326	10	-	10	50	30	230V-1N	2.000	1.300	790x800x1.420	-
		60	19048757										

(*) Productions calculated in accordance with EN 17032

Roll in blast chillers

Specially designed for catering or restaurant business which use our Cook & Chill system. Blast chillers are an essential element in the cook-chill-regenerate chain.



General characteristics

- Inside and outside made of high quality austenitic stainless steel.
- With our insulation by means of injected 40 kg/m³ polyurethane, we are 20 % above the market average, particularly for freezing performance and with a noticeable reduction in consumption. (70 mm thick insulation in refrigerated models and 100 mm thick insulation in mixed models).
- Eco-friendly coolant R452a .
- Forced draught cooling system with optimised air circulation.
- Tropicalised cooling unit. Suitable to work at a room temperature up to 43 °C and 65 % humidity.
- Hermetically sealed compressor/scroll/ semi-hermetic with ventilated condenser.
- Electronic and digital control of defrosting temperature.
- Opened door delay alarm.
- HACCP tracking system with alarm and temperature log. An optional printer can be installed to print data.
- USB data extraction.
- Heated probe.
- Bottom:
 - CSK models: refrigeration cells without any bottom. 2 mm thick steel bottom.
 - CMK models: mixed cells. 100 mm thick bottom board with 40 kg/m³ injected polyurethane insulation.
- Control panel with touch screen.

Roll in blast chillers- for trolleys



202 OVEN WITH TROLLEY



201

NO. OF DOORS	TROLLEY SIZE	UNIT	REFRIGERATED		MIXED	
			STANDARD	ENHANCED	STANDARD	ENHANCED
1 door	201 (GN-1/1)	Cell	CSK-201	CSKP-201	CMK-201	CMKP-201
		Cooling unit	UCS-424	UCS-528	UCC-424	UCC-528
	202 (GN-2/1)	Cell	CSK-202	CSKP-202	CMK-202	CMKP-202
		Cooling unit	UCS-842	UCS-1052	UCC-842	UCC-1052
2 doors (Pass-through)	201 (GN-1/1)	Cell	CSK-201-D	CSKP-201-D	CMK-201-D	CMKP-201-D
		Cooling unit	UCS-424	UCS-528	UCC-424	UCC-528
	202 (GN-2/1)	Cell	CSK-202-D	CSKP-202-D	CMK-202-D	CMKP-202-D
		Cooling unit	UCS-842	UCS-1052	UCC-842	UCC-1052

Roll in blast chillers

MODEL	CODE	TROLLEY TYPE	PRODUCTION (KG)/CYCLE	TENSION	HZ. (s)	CONDENS. UNIT.	DIMENSIONS (MM)	€
			+90 / +3 °C					
CSK-201	19048108	20 GN-1/1	70	230V 1+N	50/60	UCS-424	1.480x1.205x2.120	-
CSKP-201	19048109	20 GN-1/1	105	230V 1+N	50/60	UCS-528	1.480x1.205x2.120	-
CSK-202	19048110	20 GN-2/1	150	230V 1+N	50/60	UCS-842	1.670x1.395x2.120	-
CSKP-202	19048112	20 GN-2/1	210	400V 3+N	50	UCS-1052	1.670x1.395x2.120	-
CSK-201-D	19048092	20 GN-1/1	70	230V 1+N	50/60	UCS-424	1.480x1.205x2.120	-
CSKP-201-D	19048096	20 GN-1/1	105	230V 1+N	50/60	UCS-528	1.480x1.205x2.120	-
CSK-202-D	19048097	20 GN-2/1	150	230V 1+N	50/60	UCS-842	1.670x1.395x2.120	-
CSKP-202-D	19048100	20 GN-2/1	210	400V 3+N	50	UCS-1052	1.670x1.395x2.120	-

Condensing units for roll in blast chilliers

MODEL	CODE	POWER (W)		HZ. (s)	WEIGHT (KG)	DIMENSIONS (MM)	€
		COOLING	ELECTRIC - 400V 3+N				
UCS-424	19017466	5.970	4.250	50	135	1.100x805x650	-
UCS-528	19017467	6.950	4.980	50	139	1.100x805x650	-
UCS-842	19017468	10.530	6.500	50	205	1.450x850x785	-
UCS-1052	19017469	13.580	8.450	50	214	1.450x850x785	-

Roll in blast chillers freezers

MODEL	CODE	TROLLEY TYPE	PRODUCTION (KG)/CYCLE		TENSION	HZ. (s)	CONDENS. UNIT.	DIMENSIONS (MM)	€
			+90/+3 °C	+90/-18 °C					
CMK-201	19048104	20 GN-1/1	70	48	230V 1+N	50/60	UCC-424	1.530x1.255x2.220	-
CMKP-201	19048105	20 GN-1/1	105	70	230V 1+N	50/60	UCC-528	1.530x1.255x2.220	-
CMK-202	19048106	20 GN-2/1	150	100	230V 1+N	50/60	UCC-842	1.720x1.445x2.220	-
CMKP-202	19048107	20 GN-2/1	210	135	400V 3+N	50	UCC-1052	1.720x1.445x2.220	-
CMK-201-D	19048101	20 GN-1/1	70	48	230V 1+N	50/60	UCC-424	1.530x1.255x2.220	-
CMKP-201-D	19048102	20 GN-1/1	105	70	230V 1+N	50/60	UCC-528	1.530x1.255x2.220	-
CMK-202-D	19048103	20 GN-2/1	150	100	230V 1+N	50/60	UCC-842	1.720x1.445x2.220	-
CMKP-202-D	19048113	20 GN-2/1	210	135	400V 3+N	50	UCC-1052	1.720x1.445x2.220	-

Condensing units for roll in blast chillers freezers

MODEL	CODE	POWER (W)		HZ. (s)	WEIGHT (KG)	DIMENSIONS (MM)	€
		COOLING	ELECTRIC - 400V 3+N				
UCC-424	19015799	5.970	4.250	50	135	1.100x805x650	-
UCC-528	19015800	6.950	4.980	50	139	1.100x805x650	-
UCC-842	19015801	10.530	6.500	50	205	1.450x850x785	-
UCC-1052	19015802	13.580	8.450	50	214	1.450x850x785	-

* For other voltages and frequencies, consult the manufacturer.

Options - factory fitted

DESCRIPTION	€
Cell with HACCP printer	-

Access ramp to roll in blast chillers

MODEL	CODE	DESCRIPTION	WIDTH (MM)	€
RC-700	19015797	Access ramp for 201 type cells with floor	700	-
RC-800	19015798	Access ramp for 202 type cells with floor	800	-



A wide range of types
and sizes of ice.



Find out more!



Access the website

Ice makers

Ice makers	271
Solid ice-cube makers.....	272
Hollow ice-cube makers.....	274
Dice-shaped ice-cube makers	275
Modular nugget ice makers.....	277
Granular ice makers	277
Flake ice makers	278
Tank for modular ice-cube makers (Silo) and carts	279
Filters and accesories.....	280

Special units or any variations on the standard model must be assembled at the factory at an additional charge over the standard model's price.

Please, contact Fagor Industrial for any other variation or option that is not included on this list.

Ice makers



A WIDE RANGE OF PRODUCTS TO PRODUCE ICE IN A LARGE VARIETY OF SIZES AND SHAPES.

Overdimensioned condensers for hot climate conditions both for air and water refrigerated versions.
Simple, reliable ice making system intended to be used with heavily lime scaled water and under hard working conditions.

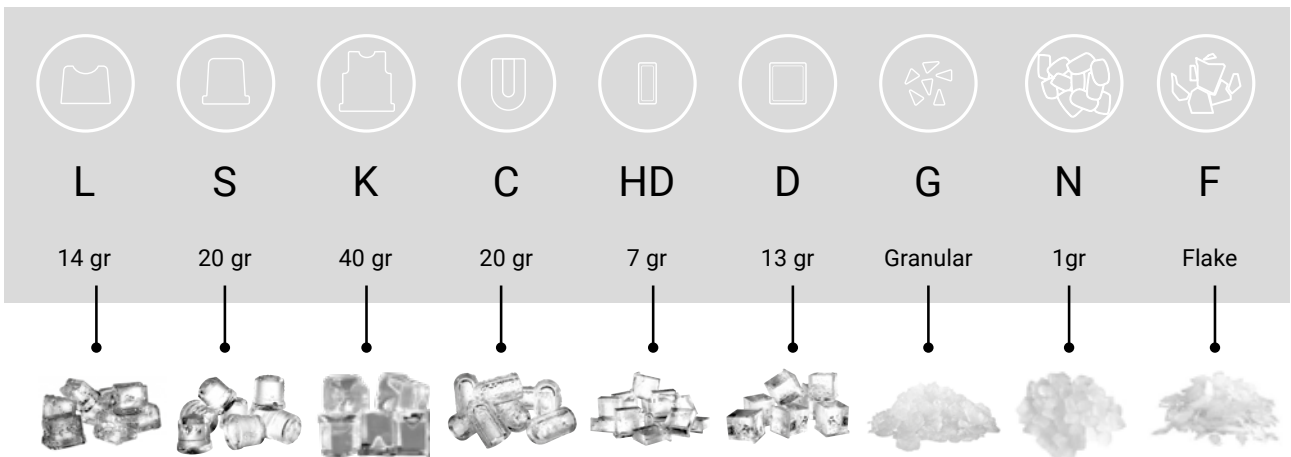

Ice cube types, versions and sizes



UNITS	PRODUCTION KG / DAY	CUBE		HOLLOW	DICE		GRANULAR	
		L - 17 G	S - 20 G	K - 40 G	C - 25 G	HD - 7 G	D - 13 G	DRY
 UNITS WITH BUILT-IN TANK	20	FIM-L		FIM-C				
	30		FIM-S	FIM-K	FIM-C			
	40		FIM-S	FIM-K	FIM-C			
	45							GIM
	60		FIM-S	FIM-K	FIM-C	FICE-HD	FICE-D	
	80 - 90		FIM-S	FIM-K	FIM-C	FICE-HD	FICE-D	GIM
	130-140		FIM-S	FIM-K	FIM-C	FICE-HD	FICE-D	GIM
 MODULAR UNITS	150	MFIM-S	MFIM-K					MGIM
	200				MFIM-C	FICE-HD	FICE-D	MGIM
	400		MFIM-S	MFIM-K		FICE-HD	FICE-D	MGIM
	500							MGIM

Solid ice-cube makers



With built-in tank

Crystal clear and compact Gourmet ice cubes take a long time to melt while chilling your drink.

Large compact Gourmet ice cubes are highly demanded by professionals and consumers. They are ideal for alcohol free drinks and spirits.

These ice cubes melt very slowly and consumers can enjoy their drinks at their ease.

Gourmet type ice cubes

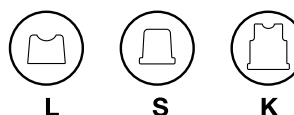

General characteristics

- High efficiency machines, low energy consumption.
- Made of AISI-304 high quality steel and built-in door.
- Hazard-free stainless steel inward opening door.
- Front ventilation system.

- Outside ON/OFF switch.
- Flexible injectors for improved performance with heavily scaled water supply.
- Machines with electronics for optimal control with high performance. Made by top performance electromechanical equipment.

A limescale filter is recommended for water with high limescale content.

- Kg/24h production capacity at 20 °C room temperature and 15 °C water supply.
- 3/4" water inlet.
- Single phase 230V/50Hz connection (230V/60Hz optional connection).

	MODEL	CONDENS. SYSTEM	CODE	ICE CUBE		COOLANT	PRODUCTION (KG/DAY)	TANK		POWER (W)	DIMENSIONS (MM)	€
				FORM	GRAMS			(KG)	ICE CUBES			
	EFIM-20L	Air	19001066		14	R290	23	6	385	260	350x470x590	-
		Water	19082343				21					
	EFIM-30S	Air	19031770		20	R290	44	15	652	356	435x605x695	-
		Water	19082344				40					
	EFIM-30K	Air	19001068		40	R290	44	15	417	356	435x605x695	-
		Water	19082345				40					
	EFIM-40S	Air	19031772		20	R290	48	15	870	510	435x605x695	-
		Water	19082347				44					
	EFIM-40K	Air	19001072		40	R290	48	15	556	510	435x605x695	-
		Water	19082348				44					
	EFIM-60S	Air	19031774		20	R290	65	30	1.087	510	515x640x830	-
		Water	19082349				59					
	EFIM-60K	Air	19001076		40	R290	65	30	694	510	515x640x830	-
		Water	19082370				59					
	EFIM-80S FIM-80S	Air	19031776		20	R290	74	40	1.522	775	645x640x860	-
		Water	19031777			R452A	80					
	EFIM-80K FIM-80K	Air	19082371		40	R290	74	40	972	780	645x640x860	-
		Water	19001083			R452A	80					
	EFIM-130S FIM-130S	Air	19082372		20	R290	136	60	3.261	1.350	930x565x1.050	-
		Water	19031779			R452A	136					
	EFIM-130K FIM-130K	Air	19082373		40	R290	136	60	2.083	1.350	930x565x1.050	-
		Water	19001065			R452A	136					

Modular





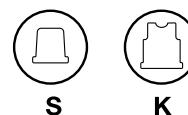





Gourmet type ice cubes



General characteristics

- Highly efficient equipment, low power consumption.
- Flexible injectors for improved performance with heavily scaled water supply.
- Stackable units by means of specific stacking kit.
- Troubleshooting acoustic alarm (only 400 model).
- Cleaning function for regular maintenance (only 400 model).
- Kg/24h production capacity at 20 °C room temperature and 15 °C water supply.
- R404a coolant.
- 3/4" water inlet.
- Single phase 230V/50Hz connection (220V/60Hz optional connection).
- Except for MFIM-400 models 380V/3N/50Hz (220V/60HZ optional).

	MODEL	CONDENS. SYSTEM	CODE	ICE CUBE		COOLANT	PRODUCTION (KG/DAY)	TANK		POWER (W)	DIMENSIONS (MM)	€
				FORM	GRAMS			(KG)	ICE CUBES			
	MFIM-150S	Air	19031792		20	R452A	153	-	-	1.500 - 1+N	775x625x805	-
		Water	19031793			R452A						
	MFIM-150K	Air	19001092		40	R452A	153	-	-	1.500 - 1+N	775x625x805	-
		Water	19001094			R452A						
	MFIM-400S	Air	19031794		20	R452A	380	-	-	3.300 - 3+N	1.321x638x978	-
		Water	19031795			R452A						
	MFIM-400K	Air	19031796		40	R452A	380	-	-	3.300 - 3+N	1.321x638x978	-
		Water	19031797			R452A						

Hollow ice-cube makers



Hollow ice-cubes to chill your drink more quickly thanks to an increased contact surface.

Made by means of top performance electromechanical equipment that uses an advanced paddle system suitable for heavily lime scaled water even without a filter.

A new design of the evaporator for an excellent performance with lime scaled water.

General characteristics

- Made of AISI-304 high quality steel and built-in door.
- Hazard-free stainless steel inward opening door.
- Front ventilation system.
- Outside ON/OFF switch.
- Height adjustable legs.
- Kg/24h production capacity at 20 °C room temperature and 15 °C water supply.
- ¾" water inlet.
- Single phase 230V/50Hz connection (220V/60Hz optional connection).



C

With built-in tank

MODEL	CONDENS. SYSTEM	CODE	ICE CUBE		COOLANT	PRODUCTION (KG/DAY)	TANK		POWER (W)	DIMENSIONS (MM)	€
			FORM	GRAMS			(KG)	ICE CUBES			
FIM-20C	Air	19031780	U	20	R452A	20	9	360	330	405x510x690	-
	Water	19031781			R452A						
FIM-30C	Air	19031782	U	20	R452A	31	12	480	330	405x510x745	-
	Water	19031783			R452A						
FIM-40C	Air	19031784	U	20	R452A	42	18	720	355	405x510x870	-
	Water	19031785			R452A						
FIM-60C	Air	19031786	U	20	R452A	60	30	1.200	425	595x555x995	-
	Water	19031787			R452A						
FIM-90C	Air	19031788	U	20	R452A	81	37	1.480	650	675x555x995	-
	Water	19031789			R452A						
FIM-130C	Air	19031790	U	20	R452A	130	50	2.000	775	845x555x995	-
	Water	19031791			R452A						



C

Modular

MODEL	CONDENS. SYSTEM	CODE	ICE CUBE		COOLANT	PRODUCTION (KG/DAY)	TANK		POWER (W)	DIMENSIONS (MM)	€
			FORM	GRAMS			(KG)	ICE CUBES			
MFIM-200C	Air	19031798	U	25	R452A	190	-	-	1.550	690x565x1.125	-
	Water	19031800			R452A						

Dice-shaped ice-cube makers



Dice and half a dice shaped ice-cubes for quick chilling of drinks at high demand business.

High performance units with vertical evaporator that can produce ice in a shorter time cycle to meet any urging demand. They are ideal for businesses with a large ice-cube demand.









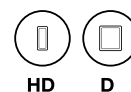







Because of the large production capacity and reduced dimensions these units are generally used by fast food restaurants and also for medical services.

General characteristics

- Highly efficient, Energy Star certificate.
 - Made of AISI-304 high quality steel and built in door.
 - Front ventilation system.
 - Cleaning function for regular maintenance.
 - Outside ON/OFF switch.
 - Height adjustable legs.
 - Kg/24h production capacity at 20 °C room temperature and 15 °C water supply.
 - ¾" water inlet.
 - Single phase 230V/50Hz connection
- (220V/60Hz optional connection).

With built-in tank











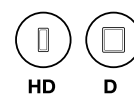

MODEL	CONDENS. SYSTEM	CODE	ICE CUBE		COOLANT	PRODUCTION (KG/DAY)	TANK		POWER (W)	DIMENSIONS (MM)	€
			FORM	GRAMS			(KG)	ICE CUBES			
 EFICE-50 D	Air	19082420		13	R452A	60	20	1.500	450	535x595x795	-
 EFICE-50 HD	Air	19082421		7	R452A	60	20	3.000	450	535x595x795	-
 EFICE-70 D	Air	19082401		13	R452A	90	35	2.692	550	660x700x838	-
 EFICE-70 HD	Air	19082402		7	R452A	90	35	5.384	550	660x700x838	-
 EFICE-100 D	Air	19082403		13	R452A	135	45	3.461	790	762x762x838	-
 EFICE-100 HD	Air	19082404		7	R452A	135	45	6.923	790	762x762x838	-
 EFICE-150D	Air	19082407		13	R290	145	45	3.461	700	762x762x832	-
 EFICE-150HD	Air	19082409		7	R290	145	45	6.923	700	762x762x832	-

Modular



- Produces full dice ice cubes or half dice ice cubes.
- High efficient evaporator.
- Smart water distributor that improves drop-off efficiency.
- Easy access by removing the panels with a single screwdriver.
- Smart electronic board controls every parameter in the machine and shows the diagnosis of possible incidences.
- High resistance external frame in AISI 304 stainless steel.



MODEL	CONDENS. SYSTEM	CODE	ICE CUBE		COOLANT	PRODUCTION (KG/DAY)	TANK		POWER (W)	DIMENSIONS (MM)	€
			FORM	GRAMS			(KG)	ICE CUBES			
 FICE-200 D	Air	19031811		13	R452A	220	-	-	1.120 - 1+N	762x620x500	-
FICE-200 HD	Air	19031813		7	R452A	220	-	-	1.120 - 1+N	762x620x500	-
 FICE-400 D	Air	19031814		13	R452A	405	-	-	1.800 - 3+N	762x620x760	-
FICE-400 HD	Air	19031815		7	R452A	405	-	-	1.800 - 3+N	762x620x760	-
FICE-300 FD FIT	Air	19082410		13	R452A	300	-	-	1.800- 1+N	559x621x659	-
FICE-300 HD FIT	Air	19082411		7	R452A	300	-	-	1.800- 1+N	559x621x659	-
FICE-300 FD FIT	Air	19082422		13	R452A	300	-	-	1.400-1+N	559x621x659	-
FICE-300 HD FIT	Air	19082423		7	R452A	300	-	-	1.400-1+N	559x621x659	-

Stock dispenser for dice ice-cube makers



Ice dispenser that can be installed on a FICE unit. To collect the ice, you only have to place a container underneath and push. Quick and easy to cover the demand from many users in a short time. Suitable for buffets, groups, hotels, catering...

General characteristics

- 104 kg tank for ice storage.
- AISI-304 stainless steel and sanitary plastic.
- Adjustable height legs.
- No need to remove the ice maker to access the tank for cleaning operations.

MODEL	CODE	CAPACITY (KG)	IN WHICH CUBE MANUFACTURERS?	DIMENSIONS (MM)	€
DISPENSER DHD	19031818	104	FICE- 200 y FICE-400	769x835x1383	-
DISPENSER DHD & WATER	19082412	104	FICE- 200 y FICE-400	769x835x1383	-
DISPENSER DHD FIT	19082413	58	FICE- 300 FD FIT	559x835x1.218	-
DISPENSER DHD FIT & WATER	19082463	58	FICE-300 FD FIT	559x835x1.218	-

Modular nugget ice makers



- Produces nugget ice.
- High evaporator efficiency: lower energy consumption and higher ice production.
- Autodiagnosis led lights signaling operation status & alerts.
- Electronic control. ON/OFF lighted switch in front panel.
- Stainless steel auger with resilient coating to maximize lifespan.
- Powerful motor gear.
- AISI 304 stainless steel body.
- Optical pinpoint control system to set ice stock level. Ice drops out through the opening on the bottom of the unit.
- Tropicalized machines (T CLASS).
- The installation of the anti-scale filter and periodic cleaning are advised in areas with medium or high limescale content (HARD WATER).



N

MODEL	CONDENS. SYSTEM	CODE	ICE CUBE		COOLANT	PRODUCTION (KG/DAY)	€
			FORM	GRAMS			
ENGIM-300A	Air	19082419		1gr	R290	310	-

Flake ice makers



- Produces cold and dry flat flakes. Flake thickness may be adjusted between 1.5mm and 3 mm.
- Based on a static cylinder which is free from swivel joints (helical reamer) coupled with a milling tool that detaches the ice without any strained or forced movements.
- The most efficient evaporator of the market, less energy consumption and higher ice production.
- Electronic stop system. Electrical control panel. Drive direct gear motor. Magnetic drive pump. Low water safety device
- Stainless steel soleplate.
- Controllers to detect: low water level, temperature rise due to motor overload or full vat.



F

MODEL	CONDENS. SYSTEM	CODE	ICE CUBE		COOLANT	PRODUCTION (KG/DAY)	€
			FORM	GRAMS			
FLAKE 1000	Air	19082465			R449	1000	-

Granular ice makers





These units can produce granular ice thanks to a vertical cylinder evaporator and a high resistance spindle. There are two types of granular ice; dry ice for cocktails and wet granular ice for fishmonger's, fruit shops...

General characteristics

- High performance electromechanical equipment that produces granular ice by means of a vertical cylinder evaporator and a high resistance spindle.
- A limescale filter and regular maintenance cleaning procedures are recommended for medium or highly limescaled water.
- Productive capacity kg/24h at room temperature 20° C and water temperature 15° C.
- Low energy consumption thanks to their high performance evaporator.
- Long life stainless steel spindle.
- Cleaning function for regular maintenance (only GIM 45 and GIM 85 models).
- IN-OUT front ventilation in counter models.
- Robust doors in counter models.
- Height adjustable legs in counter models.



With built-in tank dry granular ice











MODEL	CONDENS. SYSTEM	CODE	ICE CUBE		COOLANT	PRODUCTION (KG/DAY)	TANK		POWER (W)	DIMENSIONS (MM)	€
			FORM	GRAMS			(KG)	ICE CUBES			
 EGIM-45	Air	19001086		-	R290	74	-	-	421	465x595x795	-
	Water	19082387		-	R290	70	-	-			
EGIM-85	Air	19001088		-	R290	94	-	-	470	465x595x795	-
	Water	19082388		-	R290	90	-	-			

Wet granular ice



MODEL	CONDENS. SYSTEM	CODE	ICE CUBE		COOLANT	PRODUCTION (KG/DAY)	TANK		POWER (W)	DIMENSIONS (MM)	€
			FORM	GRAMS			(KG)	ICE CUBES			
 EGIM-135	Air	19082389		-	R290	135	-	-	650	515x550x1.355	-
	Water	19082391		-	R452A		-	-			

Modular wet granular ice

MODEL	CONDENS. SYSTEM	CODE	ICE CUBE		COOLANT	PRODUCTION (KG/DAY)	TANK		POWER (W)	DIMENSIONS (MM)	€
			FORM	GRAMS			(KG)	ICE CUBES			
 EMGIM-150 MGIM-150	Air	19082392		-	R290	142	-	-	650 - 1+N	515x550x500	-
	Water	19031820		-	R452A		-	-			
 EMGIM-200 MGIM-200	Air	19082393		-	R290	220	-	-	780 - 1+N	515x550x575	-
	Water	19031822		-	R452A		-	-			
 MGIM-400	Air	19031824		-	R452A	390	-	-	1300+3+N	675x550x660	-
	Water	19031825		-	R452A		-	-			
 MGIM-400	Air	19082397		-	R452A	565	-	-	1300 - 1+N	675x550x800	-
	Water	19082398		-	R452A		-	-			
MGIM-500	Air	19031827		-	R452A	565	-	-	1700 - 3+N	675x550x800	-
	Water	19031828		-	R452A		-	-			
MGIM-500	Air	19082399		-	R452A	565	-	-	1700 - 1+N	675x550x800	-
	Water	19082400		-	R452A		-	-			

Tank for modular ice-cube makers (Silo) and carts

Ice tanks are a guarantee to have a regular stock to meet your business's ice demand. During low consumption periods, the ice produced is stored in the modules to cover the demand during peak consumption periods.



General characteristics

- AISI-304 stainless steel tanks.
- 40 kg/m³ insulation by injected polyurethane for adequate ice keeping conditions.
- Inner design without sharp corners for easy cleaning and hygienic conditions.
- High density polyethylene and shock resistant one-piece inside.
- Stainless steel door for intensive use.
- Soft-closing doors.
- Different capacity models for all kinds of modular ice makers.
- Lower drainage.
- Ice removing shovel.
- Height adjustable legs.

General characteristics

- AISI 304 stainless steel bin.
- Hard sanitary polyethylene vat, resistant to blows, and scratches.
- Easy cleaning: seamless one-piece vat with rounded corners, avoiding possible dirty points and facilitating cleaning.
- Drainage system that collects and drives the water to the drain keeping the bin and floor clean & dry.
- Cart: has a braking and drainage system.
- Cart is made of sanitary polyethylene, with smooth surface to facilitate cleaning. It includes a cover to prevent dirt from contaminating the ice.
- Baskets for distributing ice quickly and effortlessly.

MODEL	CODE	CAPACITY (KG)	COMPATIBILITY	DIMENSIONS (MM)	€
S-130 GMIM / NGIM	19082414	160	See the different possible	762x819x740	-
S-130 FICE FIT	19082415	160	See the different possible	762x819x740	-
S-160 GMM / NGIM	19082416	180	See the different possible	559x872x1.122	-
S-160 FICE FIT	19082417	180	See the different possible	559x872x1.122	-
S-220 GMIM	19031843	220	See the different possible	762x819x1.071	-
S-220 MFIM / FICE	19031799	220	See the different possible	762x819x1.071	-
S-350 GMIM	19082374	340	See the different possible	1.067x819x1.067	-
S-350 MFIM / FICE	19082418	340	See the different possible	1.067x819x1.071	-
S-500 GMIM	19031844	500	See the different possible	1.321x872x1.122	-
S-500 MFIM / FICE	19031802	500	See the different possible	1.321x872x1.122	-
S CART 300 GMIM / NGIM	19082380	300 + 112 carro	Ver tabla combinaciones	962x1.216x2.065	-
S CART 300 FICE / MFIM 150	19082382	300 + 112 carro	Ver tabla combinaciones	962x1.216x2.065	-
S 2CART 600 GMIM / NGIM	19082383	600 + (2 x 112) carros	Ver tabla combinaciones	1.630x1.240x1.980	-
S 2CART 600 MFIM	19082384	600 + (2 x 112) carros	Ver tabla combinaciones	1.630x1.240x1.980	-
S 2CART 600 FICE	19082385	600 + (2 x 112) carros	Ver tabla combinaciones	1.630x1.240x1.980	-

Combination of silos and modular ice makers

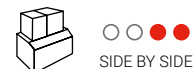
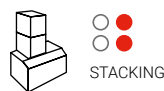
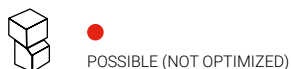

		TANKS										TANKS WITH TROLLEY				TANK WITH DISPENSER	
		S-130		S-160		S-220		S-350		S-500		S CART		S 2CART		DHD	
NUMBER OF ICE MAKERS		1	2	1	2	1	2	1	2	1	2	1	2	1	2	1	2
ICE MAKERS TYPE	ICE MAKER MODEL																
GOURMET AND HOLLOW ICE CUBES	MFIM-150	○	○	-	-	-	-	●	○	●	○	●	●	○	●	-	-
	MFIM-400	-	-	-	-	-	-	-	-	○	-	-	-	○	-	-	-
	MFIM-200C	○	-	○	-	-	-	-	-	-	-	-	-	-	-	-	-
DICE SHAPED ICE CUBES	FICE-200-D	○	○	-	-	○	○	○	○	○	○	○	●	○	○	○	○
	FICE-200-HD	○	○	-	-	○	○	○	○	○	○	○	●	○	○	○	○
	FICE-300-D FIT	○	-	○	-	○	-	○	-	-	-	○	-	○	-	○	○
	FICE-300-HD FIT	○	-	○	-	○	-	○	-	-	-	○	-	○	-	○	○
	FICE-400-D	○	●	-	-	○	○	○	○	○	○	○	●	○	-	○	○
	FICE-400-HD	○	●	-	-	○	○	○	○	○	○	○	●	○	-	○	○
GRANULATED ICE	MGIM-150	○	-	○	-	●	-	○	●	●	●	●	●	-	●	-	●
	MGIM-200	○	-	○	-	○	-	○	○	●	○	○	-	●	-	●	-
	MGIM-400	○	-	●	-	○	-	○	-	○	-	○	-	○	-	○	-
	MGIM-500	○	-	●	-	○	-	○	-	○	-	○	-	○	-	○	-
ICE NUGGET	NGIM 300A	○	-	-	-	○	-	○	-	○	-	○	-	●	-	○	-
ICE FLAKES	FLAKE1000	-	-	-	-	-	-	-	-	-	-	-	-	●	-	-	-

* The silos cover may vary depending on the ice maker model.

Filters and accessories

MODEL	CHARACTERISTICS	CODE	€
ICE CRUSHER	Crusher	19082464	-
FC-100	Lime scale filter	19038797	-
FP-100	Particles	19038798	-
CC-100	Spare part	19038799	-
CP-100	Spare cartridge particles	19038800	-
CS-101	Anti-scale / active carbon / particulate filter	19031839	-
CS-102	Anti-scale / active carbon / particulate filter	19082428	-
SMALL SHOVEL	Small shovel	19082429	-
MEDIUM SHOVEL	Medium shovel	19082462	-
STACKING KIT MFIM 150	Stacked kit	19082425	-
STACKING KIT MFIM 400	Stacked kit	19082426	-
STACKING KIT FICE	Stacked kit	19082427	-



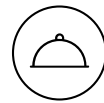

Distribution



Distribution

Drop-in.....	285
Self-service.....	305
Wine cellars and dry ager cabinets.....	327
Trolleys and counters for distribution .	337



**Make your designs
come true with the
widest range.**



Find out more!



Access the website



Full price list

Drop-in

Refrigerated Elements.....	287
Hot Elements	289
Showcooking Elements.....	291
Undercounter Elements.....	293
Foodshields	294
Glasses	296
Refrigerated Displays.....	298
Hot Displays	300
Reserves and Dispensers.....	301
Showcase Displays	303
Accessories	304

Refrigerated elements



General characteristics

- Specially designed to hold, display and serve chilled food, keeping the product at optimum temperatures during service time.
- Manufactured in stainless steel with satin finish.
- Top plate and static well refrigeration system by expanded copper coil located in their base.
- Ventilated well refrigeration system generated by evaporator fans, creating a gentle air curtain over the upper part of the well.
- Wells with rounded corners inside to make cleaning operations easier, ensuring maximum hygiene.

- Automatic defrost system that minimizes compressor workload and saves energy.
- Polyurethane insulation with ecological injection, allowing energy savings by reducing loss of cold air.

- Control panel with digital thermostat, protected by the structure perimeter, avoiding hindrances in their daily use.

- Robust structure with 13 mm thick overlap, once element is dropped-in on the worktop, ensuring cleanness and aesthetics.





PR6-4



P2R6-4



CR6-160-4

MODEL	GAS	HZ	CODE	DIMENSIONS (mm)	CUT-OUT DIMENSIONS (mm)	WELL DEPTH (mm)	GN 1/1 CAPACITY	POWER (W)	CLIMATE CLASS	COLD GROUP	€
1 LEVEL STATIC REFRIGERATED PLATE											
PR6-3	R452a	50	19043172	1115x610x476	1090x585	-	3	320	IV	Included	-
		60	19068142					385			-
 PR6-4	R452a	50	19043173	1440x610x476	1415x585	-	4	335	IV	Included	-
		60	19068143					400			-
PR6-5	R452a	50/60	19043174	1765x610x746	1740x585	-	5	580	IV	Included	-
2 LEVEL STATIC REFRIGERATED PLATE											
P2R6-3	R452a	50	19043175	1115x610x546	1090x585	-	3	320	IV	Included	-
		60	19068131					385			-
 P2R6-4	R452a	50	19043176	1440x610x546	1415x585	-	4	335	IV	Included	-
		60	19068132					400			-
P2R6-5	R452a	50/60	19043177	1765x610x546	1740x585	-	5	580	IV	Included	-
STATIC REFRIGERATED WELL											
 CR6-160-3	R452a	50	19043184	1115x610x632	1090x585	160	3	325	IV	Included	-
		60	19068108					395			-
CR6-160-4	R452a	50/60	19043186	1440x610x632	1415x585	160	4	630	IV	Included	-
		50/60	19043187					690			-
CR6-160-5	R452a	50/60	19043187	1765x610x632	1740x585	160	5	690	IV	Included	-



CRV7-4









CNH6-120-4



CMC6-4



CHMP-450

MODEL	GAS	HZ	CODE	DIMENSIONS (mm)	CUT-OUT DIMENSIONS (mm)	WELL DEPTH (mm)	GN 1/1 CAPACITY	POWER(W)	CLIMATE CLASS	COLD GROUP	€
VENTILATED REFRIGERATED WELL											
 CRV7-3	R452a	50/60	19043178	1115x720x677	1090x690	30 - 75 - 115	3	530	IV	Included	-
 CRV7-4	R452a	50/60	19043179	1440x720x677	1415x690	30 - 75 - 115	4	750	IV	Included	-
CRV7-5	R452a	50/60	19043181	1765x720x677	1740x690	30 - 75 - 115	5	820	IV	Included	-
NEUTRAL ICE WELL											
 CNH6-120-4	-	50/60	19043188	1440x610x348	1415x585	120	4	60	-	-	-
FROZEN PRODUCTS WELL											
 CMC6-4	R452a	50/60	19043189	835x610x678	810x585	180	4 pans de 360x165x180 mm	245	IV	Included	-
DIPPER WELL											
 ICLP	-	-	19081905	270x110x145	260x100	-	-	-	-	-	-
NEUTRAL CHAMPAGNE STATION											
 CHMP-450	-	-	19081572	Ø 610x470	Ø 585	310	-	30	-	-	-

Available options

	FREQUENCY HZ	EXTERNAL WIDTH (mm)	GN 1/1 CAPACITY	WELL DEPTH (mm)	CLIMATE CLASS	COLD GROUP
1 LEVEL STATIC REFRIGERATED PLATE	50-60	610-720	2-3-4-5-6	-	IV-V	Included-Remote
2 LEVEL STATIC REFRIGERATED PLATE	50-60	610-720	2-3-4-5-6	-	IV-V	Included-Remote
STATIC REFRIGERATED WELL	50-60	610-720	2-3-4-5-6	30-80-160	IV-V	Included-Remote
VENTILATED REFRIGERATED WELL*	50-60	-	2-3-4-5-6	-	IV-V	Included-Remote
NEUTRAL ICE WELL	-	610-720	2-3-4-5-6	80-120	-	-
FROZEN PRODUCTS WELL	50-60	610-720	-	-	IV-V	Included-Remote

*120 mm depth neutral ice well includes RGB LED at the bottom.

Hot elements



General characteristics

- Specially designed to hold, display and serve hot food, keeping the product at optimum temperatures during service time.
- Manufactured in stainless steel with satin finish.
- Glass ceramic heating system by hidden silicon resistors attached to the bottom of the plate.
- Dry bain marie heating system by a set of resistor modules with fans.
- Wet bain marie heating system by hidden silicon resistors attached to the bottom of the well.

- Wells with rounded corners inside to make cleaning operations easier, ensuring maximum hygiene.

- Control panel with digital thermostat, protected by the structure perimeter, avoiding hindrances in their daily use.

- Robust structure with 13 mm thick overlap, once element is dropped-in on the worktop, ensuring cleanness and aesthetics.







PV6-4



PVE11-4



CBMS6-4

MODEL	HZ	CODE	DIMENSIONS (mm)	CUT-OUT DIMENSIONS (mm)	WELL DEPTH (mm)	GN 1/1 CAPACITY	COLOUR	POWER(W)	€
GLASS CERAMIC PLATE									
 PV6-3	50/60	19043199	1115x610x147	1090x585	-	3	Black	1355	-
 PV6-4	50/60	19043201	1440x610x147	1415x585	-	4	Black	1805	-
PV6-5	50/60	19043202	1765x610x147	1740x585	-	5	Black	2255	-
FRAMELESS GLASS CERAMIC PLATE									
PVE11-3	50/60	19081564	987X530X137	981x536	-	3	Black	1355	-
 PVE11-4	50/60	19081566	1312X530X137	1306x536	-	4	Black	1805	-
PVE11-5	50/60	19081568	1637X530X137	1631x536	-	5	Black	2255	-
DRY BAIN MARIE WELL									
 CBMS6-3	50/60	19043190	1115x610x373	1090x585	210	3		1550	-
 CBMS6-4	50/60	19043191	1440x610x373	1415x585	210	4		2050	-
CBMS6-5	50/60	19043192	1765x610x373	1740x585	210	5		3080	-



CBMA6-4



OS1-10

MODEL	HZ	CODE	DIMENSIONS (mm)	CUT-OUT DIMENSIONS (mm)	WELL DEPTH (mm)	GN 1/1 CAPACITY	WATER FILLING TYPE	POWER(W)	€
WET BAIN MARIE WELL									
CBMMA6-1	50/60	19051982	465x610x332	440x585	190	1	Manual with bucket	1010	-
CBMA6-1	50/60	19043193	515x610x302	490x585	190	1	Manual with tap	1010	-
CBMA6-2	50/60	19043194	790x610x302	765x585	190	2	Manual with tap	1510	-
CBMA6-3	50/60	19043195	1115x610x302	1090x585	190	3	Manual with tap	2005	-
CBMA6-4	50/60	19043196	1440x610x302	1415x585	190	4	Manual with tap	2510	-
CBMA6-5	50/60	19043197	1765x610x302	1740x585	190	5	Manual with tap	3030	-
CBMAA6-3	50/60	19047657	1115x610x302	1090x585	190	3	Automatic	2025	-
CBMAA6-4	50/60	19047658	1440x610x302	1415x585	190	4	Automatic	2525	-
CBMAA6-5	50/60	19047659	1765x610x302	1740x585	190	5	Automatic	3045	-

MODEL	HZ	CODE	DIMENSIONS (mm)	CUT-OUT DIMENSIONS (mm)	CAPACITY (l)	POWER (W)	€
SOUP WELL							
OS1-10	50/60	19083985	Ø 295X315	Ø 276	10	475	-

Available options

	EXTERNAL WIDTH (mm)	GN 1/1 CAPACITY	COLOUR	WATER FILLING TYPE
GLASS CERAMIC PLATE	610-720	2-3-4-5-6	Black - White	-
FRAMELESS GLASS CERAMIC PLATE	610-720	2-3-4-5-6	Black - White	-
DRY BAIN MARIE WELL	610-720	2-3-4-5-6	-	-
WET BAIN MARIE WELL	610-720	1-2-3-4-5-6	-	Manual-Automatic

Showcooking elements



General characteristics

- Specially designed to hold, display, prepare and serve food at showcooking stations.
- Manufactured in stainless steel with satin finish.
- Control panel with digital thermostat, protected by the structure perimeter, avoiding hindrances in their daily use.
- Robust structure with 13 mm thick overlap, once element is dropped-in on the worktop, ensuring cleanness and aesthetics.



TPY6-2





CRE6-80-2







TRCBMA6-2



CBMA16-4

MODEL	GAS	HZ	CODE	DIMENSIONS (mm)	CUT-OUT DIMENSIONS (mm)	WELL DEPTH (mm)	GN 1/1 CAPACITY	POWER(W)	CLIMATE CLASS	COLD GROUP	€
ICE CREAM TEPPANYAKI											
 TPY6-2	R452a	50/60	19081538	790x610x634	765x585	30	2	1215	IV	Included	-
FRESH PRODUCT SHOWCASE WELL											
 CRE6-80-1	R452a	50/60	19081550	487x621x817	440x585	80	1	260	IV	Included	-
 CRE6-80-2	R452a	50/60	19081551	812x621x817	765x585	80	2	305	IV	Included	-

MODEL	HZ	CODE	DIMENSIONS (mm)	CUT-OUT DIMENSIONS (mm)	WELL DEPTH (mm)	GN 1/1 CAPACITY	WATER FILLING TYPE	POWER(W)	€
CARVING STATION									
 TRCBMA6-1	50/60	19079228	515x610x1005	490x585	190	1 GN 1/1	Manual with tap	1285	-
 TRCBMA6-2	50/60	19079229	790x610x1005	765x585	190	2 GN 1/1	Manual with tap	2560	-
WET BAIN MARIE WELL FOR SAUCES									
 CBMA16-3	50/60	19081533	576x256x252	551x231	145	3 GN 1/6	Manual with tap	810	-
 CBMA16-4	50/60	19081534	738x256x252	713x231	145	4 GN 1/6	Manual with tap	810	-





CBMS16-4



PV3-4



PV3-4

MODEL	HZ	CODE	DIMENSIONS (mm)	CUT-OUT DIMENSIONS (mm)	WELL DEPTH (mm)	GN 1/1 CAPACITY	COLOUR	POWER (W)	€
DRY BAIN MARIE WELL FOR SAUCES									
 CBMS16-3	50/60	19081509	576x256x252	551x227	105	3 GN 1/6	-	860	-
CBMS16-4	50/60	19081524	738x256x252	713x227	105	4 GN 1/6	-	1210	-
SHOWCOOKING GLASS CERAMIC PLATE									
 PV3-4	50/60	19069518	1440x295x147	1415x282		4 GN 1/1	Black	510	-
PV3-5	50/60	19069519	1765x295x147	1740x282		4 GN 1/1	Black	610	-
PAELLA DISPLAY PLATE									
 PVEP-530	50/60	19081549	Ø 630x604	Ø 605	-	-	Black	935	-

Available options

	EXTERNAL WIDTH (mm)	GN 1/1 CAPACITY	COLOUR	WATER FILLING TYPE	CLIMATE CLASS	COLD GROUP
ICE CREAM TEPPANYAKI	610-720	-	-	-	IV-V	Included - Remote
FRESH PRODUCT SHOWCASE WELL	610-720	1-2 GN 1/1	-	-	IV-V	Included - Remote
CARVING STATION	610-720	1-2 GN 1/1	-	Manual-Automatic	-	-
WET BAIN MARIE WELL FOR SAUCES	-	3-4 GN 1/6	-	Manual-Automatic	-	-
DRY BAIN MARIE WELL FOR SAUCES	-	3-4 GN 1/6	-	-	-	-
SHOWCOOKING GLASS CERAMIC PLATE	-	2-3-4-5 GN 1/1	Black - White	-	-	-

Undercounter elements



General characteristics

- Specially designed to be mounted under a countertop, keeping the product at optimum temperatures during service time.
- Factory-approved countertop materials include granite and quartz (Silestone®) up to 20 mm. Please contact factory for applications with other materials.
- Expansion joint installation on the countertop needed.
- Top plate aluminum surface for a better diffusion of cold/hot on the worktop thanks to its high thermal conductivity.

- Refrigerated plate cooling system by expanded copper coil located in its base.
- Hot plate with heating system by hidden silicon resistors attached to the top of the

- plate.
- Total seamless countertop, maximizing hygiene, tightness and aesthetics.







- Electronic thermostat, with digital display, to control and regulate the temperature on the worktop at the desired set point.



PBCF-4



PBCC-4

MODEL	GAS	HZ	CODE	DIMENSIONS (mm)	GN 1/1 CAPACITY	POWER(W)	CLIMATE CLASS	COLD GROUP	€
UNDERCOUNTER REFRIGERATED PLATE									
 PBCF-3	R452a	50/60	19078484	936x590x476	3	390	IV	Included	-
 PBCF-4	R452a	50/60	19078485	1261x590x476	4	510	IV	Included	-
 PBCF-5	R452a	50	19078486	1586x590x476	5	550	IV	Included	-
		60	19078487						-
UNDERCOUNTER HOT PLATE									
 PBCC-3	-	50/60	19078508	936x590x147	3	1355	-	-	-
 PBCC-4	-	50/60	19078509	1261x590x147	4	1805	-	-	-
 PBCC-5	-	50/60	19078510	1586x590x147	5	2255	-	-	-

Available options

	GN 1/1 CAPACITY	CLIMATE CLASS	COLD GROUP
UNDERCOUNTER REFRIGERATED PLATE	2-3-4-5-6	IV-V	Included- Remote
UNDERCOUNTER HOT PLATE	2-3-4-5-6	-	-

Foodshields



General characteristics

- Specially designed to improve food hygiene as well as to guarantee guest protection.
- Brackets manufactured in stainless steel, in oblong or rectangular tube.
- 35 mm distance between bracket and foodshield to make cleaning operations easier.
- Brackets are easily mounted on the structure by means of threaded plates.



IPL-4



IPL-R-4



IPC-R-4



IPC-R-4

	MODEL	HZ	CODE	DIMENSIONS (mm)	CUT-OUT DIMENSIONS (mm)	GN 1/1 CAPACITY	FUNCTION	BRACKET	POWER(W)	€
FOODSHIELD WITH LIGHT										
	IPL-3	50/60	19043257	1089x142x483	1045	3	Light	Oblong	25	-
	IPL-4	50/60	19043258	1414x142x483	1370	4	Light	Oblong	35	-
	IPL-5	50/60	19043259	1739x142x483	1695	5	Light	Oblong	45	-
	IPL-R-3	50/60	19043277	1085x142x483	1045	3	Light	Rectangular	25	-
	IPL-R-4	50/60	19043278	1410x142x483	1370	4	Light	Rectangular	35	-
	IPL-R-5	50/60	19043279	1735x610x483	1695	5	Light	Rectangular	45	-
FOODSHIELD WITH HALOGEN HEAT										
	IPC-2	50/60	19043260	764x142x483	720	2	Light and heat	Oblong	600	-
	IPC-3	50/60	19043261	1089x142x483	1045	3	Light and heat	Oblong	900	-
	IPC-4	50/60	19043262	1414x142x483	1370	4	Light and heat	Oblong	1200	-
	IPC-5	50/60	19043263	1739x142x483	1695	5	Light and heat	Oblong	1500	-
	IPC-R-2	50/60	19043280	760x142x483	720	2	Light and heat	Rectangular	600	-
	IPC-R-3	50/60	19043281	1085x142x483	1045	3	Light and heat	Rectangular	900	-
	IPC-R-4	50/60	19043283	1410x142x483	1370	4	Light and heat	Rectangular	1200	-
	IPC-R-5	50/60	19043284	1735x142x483	1695	5	Light and heat	Rectangular	1500	-



IPC-4-C











ISPC



IPMC-R



IPM-R-4

MODEL	HZ	CODE	DIMENSIONS (mm)	CUT-OUT DIMENSIONS (mm)	GN 1/1 CAPACITY	FUNCTION	BRACKET	POWER(W)	€	
FOODSHIELD WITH CERAMIC HEAT										
	IPC-2 C	50/60	19043267	764x142x483	720	2	Light and ceramic heat	Oblong	600	-
	IPC-3 C	50/60	19043268	1089x142x483	1045	3	Light and ceramic heat	Oblong	1050	-
	IPC-4 C	50/60	19043269	1414x142x483	1370	4	Light and ceramic heat	Oblong	1300	-
	IPC-5 C	50/60	19043270	1739x142x483	1695	5	Light and ceramic heat	Oblong	1650	-
	IPC-R-2 C	50/60	19043285	760x142x483	720	2	Light and ceramic heat	Rectangular	600	-
	IPC-R-3 C	50/60	19043287	1085x142x483	1045	3	Light and ceramic heat	Rectangular	1050	-
	IPC-R-4 C	50/60	19043288	1410x142x483	1370	4	Light and ceramic heat	Rectangular	1300	-
	IPC-R-5 C	50/60	19043289	1735x142x483	1695	5	Light and ceramic heat	Rectangular	1650	-
NEUTRAL BRACKET										
	ISPC		19043271	68x83x483	-	-	Neutral	Oblong	-	-
	ISPC-R		19043291	68x85x483	-	-	Neutral	Rectangular	-	-
HEATING LAMP										
	IPMC	50/60	19043325	534x138x468	-	-	Light and heat	Oblong	300	-
	IPMC-R	50/60	19043489	532x138x465	-	-	Light and heat	Rectangular	300	-
FOODSHIELD FOR FROZEN PRODUCTS WELL										
	IPM-4	50/60	19052976	809x142x483	765	4 pans 360x165x180 mm	Light	Oblong	15	-
	IPM-R-4	50/60	19052977	808x142x483	765	4 pans 360x165x180 mm	Light	Rectangular	15	-

Available options

	GN 1/1 CAPACITY	BRACKET
FOODSHIELD WITH LIGHT	2 - 3 - 4 - 5 - 6	Oblong - Rectangular
FOODSHIELD WITH HALOGEN HEAT	2 - 3 - 4 - 5 - 6	Oblong - Rectangular
FOODSHIELD WITH CERAMIC HEAT	2 - 3 - 4 - 5 - 6	Oblong - Rectangular
NEUTRAL BRACKET	-	Oblong - Rectangular
HEATING LAMP	-	Oblong - Rectangular
FOODSHIELD FOR FROZEN PRODUCTS WELL	-	Oblong - Rectangular

Glasses

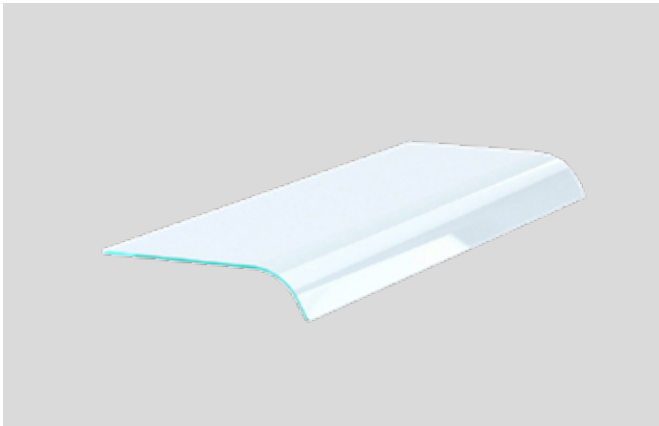

General characteristics

- Straight or curved tempered glasses.
- Easy installation of glasses to foodshields by means of clamps.



ICC-4-1C

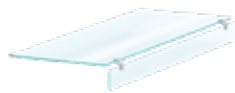

ICC-R-4-1C



ICC-4-2C



ICC-R-4-2C

MODEL	CODE	DIMENSIONS (mm)	GN 1/1 CAPACITY	GLASS SHAPE	€	
FRONTAL GLASS						
	ICC-2-1C	19043272	675x500x108	2	Curved	-
	ICC-3-1C	19043273	1000x500x108	3	Curved	-
	ICC-4-1C	19043274	1325x500x108	4	Curved	-
	ICC-5-1C	19043275	1650x500x108	5	Curved	-
	ICC-R-2-1C	19043293	675x433x123	2	Straight	-
	ICC-R-3-1C	19043295	1000x433x123	3	Straight	-
	ICC-R-4-1C	19043296	1325x433x123	4	Straight	-
	ICC-R-5-1C	19043297	1650x433x123	5	Straight	-
	CENTRAL GLASS					
	ICC-2-2C	19046893	675x570x108	2	Curved	-
	ICC-3-2C	19046894	1000x570x108	3	Curved	-
	ICC-4-2C	19046895	1325x570x108	4	Curved	-
	ICC-5-2C	19046896	1650x570x108	5	Curved	-
	ICC-R-2-2C	19043298	675x585x123	2	Straight	-
	ICC-R-3-2C	19043301	1000x585x123	3	Straight	-
	ICC-R-4-2C	19043302	1325x585x123	4	Straight	-
	ICC-R-5-2C	19043303	1650x585x123	5	Straight	-



ICC-FP-4



ICC-R-FP-4



ICCM-4-1C



ICCM-R-4-2C

MODEL	CODE	DIMENSIONS (mm)	GN 1/1 CAPACITY	GLASS SHAPE	€	
CLOSED FRONTAL GLASS						
	ICC-FP-2	19051996	675x515x477	2	Curved	-
	ICC-FP-3	19051997	1000x515x477	3	Curved	-
	ICC-FP-4	19051998	1325x515x477	4	Curved	-
	ICC-FP-5	19051999	1650x515x477	5	Curved	-
	ICC-R-FP-2	19052001	675x433x483	2	Straight	-
	ICC-R-FP-3	19052002	1000x433x483	3	Straight	-
	ICC-R-FP-4	19052003	1325x433x483	4	Straight	-
	ICC-R-FP-5	19052004	1650x433x483	5	Straight	-
FRONTAL GLASS FOODSHIELD FOR FROZEN PRODUCTS WELL						
	ICCM-4-1C	19052981	722x500x108	4 pans 360x165x180 mm	Curved	-
	ICCM-R-4-1C	19052979	722x433x123	4 pans 360x165x180 mm	Straight	-
CENTRAL GLASS FOODSHIELD FOR FROZEN PRODUCTS WELL						
	ICCM-4-2C	19052983	722x570x108	4 pans 360x165x180 mm	Curved	-
	ICCM-R-4-2C	19052980	722x585x123	4 pans 360x165x180 mm	Straight	-

Available options

	GN 1/1 CAPACITY	GLASS SHAPE
FRONTAL GLASS	2 - 3 - 4 - 5 - 6	Curved - Straight
CENTRAL GLASS	2 - 3 - 4 - 5 - 6	Curved - Straight
CLOSED FRONTAL GLASS	2 - 3 - 4 - 5 - 6	Curved - Straight
FRONTAL GLASS FOODSHIELD FROZEN PRODUCTS WELL	-	Curved - Straight
CENTRAL GLASS FOODSHIELD FROZEN PRODUCTS WELL	-	Curved - Straight

Refrigerated Displays



General characteristics

- Specially designed to hold, display and serve chilled food and beverages, keeping the product at optimum temperatures during service time.
- Manufactured in stainless steel with satin finish.
- Ventilated displays for extended service times.
- Ventilated well refrigeration system by evaporator module fans at the back of the display.
- Automatic defrost system that minimizes compressor workload and saves energy.
- Polyurethane insulation with ecological injection, allowing energy savings by reducing loss of cold air.

- Tempered glass display sides to maximize product display and increase work safety during service operations.
- 4500°K pure white LED light strips, with 14.5 w/m power, integrated on the display.

- Control pannel with digital thermostat, protected by the structure perimeter, avoiding hindrances in their daily use.

- Robust structure with 13 mm thick overlap, once element is dropped-in on the worktop, ensuring cleanness and aesthetics.



VCR7-CT-4



VCR7-CP-4-4

MODEL	GAS	HZ	CODE	DIMENSIONS (mm)	CUT-OUT DIMENSIONS (mm)	GN 1/1 CAPACITY	CUSTOMER SIDE	SERVICE SIDE	POWER(W)	CLIMATE CLASS	COLD GROUP	€
3-LEVEL CUBIC REFRIGERATED VENTILATED DISPLAY												
	R452a	50	19043209	1115x720x1430	1090x690	3	Curtain	Swing doors	885	III	Included	-
		60	19068175						1045			-
	R452a	50	19043210	1440x720x1430	1415x690	4	Curtain	Swing doors	1190	III	Included	-
		60	19068176						1320			-
4-LEVEL CUBIC REFRIGERATED VENTILATED DISPLAY												
	R452a	50	19047716	1115x720x1870	1090x690	3	Blinds	Swing doors	885	III	Included	-
		60	19068169						1045			-
	R452a	50	19047717	1440x720x1870	1415x690	4	Blinds	Swing doors	1190	III	Included	-
		60	19068170						1320			-



VVR7-CT-4

MODEL	GAS	HZ	CODE	DIMENSIONS (mm)	CUT-OUT DIMENSIONS (mm)	GN 1/1 CAPACITY	CUSTOMER SIDE	SERVICE SIDE	POWER(W)	CLIMATE CLASS	COLD GROUP	€	
CURVED REFRIGERATED VENTILATED DISPLAY													
	VVR7-CT-3	R452a	50	19043215	1115x720x1430	1090x690	3	Curtain	Swing doors	840	III	Included	-
			60	19068229						1000			-
	VVR7-CT-4	R452a	50	19043216	1440x720x1430	1415x690	4	Curtain	Swing doors	1050	III	Included	-
			60	19068230						1185			-

Available options

	FREQUENCY HZ	GN 1/1 CAPACITY	CUSTOMER SIDE	SERVICE SIDE	CLIMATE CLASS	COLD GROUP
3-LEVEL CUBIC REFRIGERATED VENTILATED DISPLAY	50-60	2-3-4-5-6	Open - Closed - Curtain - Blind	Swing doors-Closed	III-IV	Included-Remote
4-LEVEL CUBIC REFRIGERATED VENTILATED DISPLAY	50-60	2-3-4-5-6	Open - Closed - Curtain - Blind	Swing doors-Closed	III-IV	Included-Remote
CURVED REFRIGERATED VENTILATED DISPLAY	50-60	2-3-4-5-6	Open - Closed . Curtain	Swing doors-Closed	III-IV	Included-Remote

Hot Displays



General characteristics

- Specially designed to hold, display and serve hot food, keeping the product at optimum temperatures during service time.
- Structure manufactured in stainless steel with satin finish.
- 4mm thickness, very durable glass ceramic shelf and plate.
- Heating system by hidden silicon resistors attached to the bottom of the glass ceramic plate and shelf.
- 8 mm thickness, tempered glass display sides to maximize product display and increase work safety during service operations.

- Foodshields with light and heat located over the glass ceramic plate and shelf.
- Lighting by protected halogen lamps.
- Heating by infrared high-temperature ceramic elements.
- Two (2) electronic thermostats, with

- digital display, to control and regulate the temperature on the glass ceramic plate and on the shelf separately, at the desired set point.
- Two (2) analogic thermostats to control and regulate the temperature of the ceramic elements separately, at the





- desired set point.
- Robust structure with 13 mm thick overlap, once element is dropped-in on the worktop, ensuring cleanness and aesthetics.
- Operating temperature: from +30 °C to +120 °C on glass ceramic plate and intermediate shelf.



VCC6-4



VVC6-4

MODEL	VOLTAGE AND FREQUENCY (HZ)	CODE	DIMENSIONS (mm)	CUT-OUT DIMENSIONS (mm)	CAPACITY GN 1/1	COLOUR	CUSTOMER SIDE	SERVICE SIDE	POWER (W)	€
CUBIC HOT GLASS CERAMIC DISPLAY										
 VCC6-3	400V 3N 50/60	19047790	1115x610x924	1090x585	3	Black	Open	Sliding doors	4025	-
 VCC6-4	400V 3N 50/60	19047791	1440x610x924	1415x585	4	Black	Open	Sliding doors	4700	-
CURVED HOT GLASS CERAMIC DISPLAY										
 VVC6-3	400V 3N 50/60	19043229	1115x610x924	1090x585	3	Black	Open	Sliding doors	4025	-
 VVC6-4	400V 3N 50/60	19043230	1440x610x924	1415x585	4	Black	Open	Sliding doors	4700	-

Available options

	EXTERNAL WIDTH (mm)	CAPACITY GN 1/1	COLOUR	SERVICE SIDE
CUBIC HOT GLASS CERAMIC DISPLAY	610 - 720	3 - 4 - 5 - 6	Black - White	Sliding doors - Closed
CURVED HOT GLASS CERAMIC DISPLAY	610 - 720	3 - 4 - 5 - 6	Black - White	Sliding doors - Closed

Reserves



General characteristics

- Specifically designed to be installed under a worktop in order to hold refrigerated or hot products.
- Manufactured in stainless steel with a solid and robust structure.
- Hot and cold reserve models with two different heights.
- Refrigerated reserve models with doors or drawers, for GN 2/1 or GN 1/1 pans.
- Electronic thermostat, with digital display, to control and regulate the temperature in the reserve at the desired set point.



RF4-21 DD



RCD4-11

MODEL	GAS	HZ	CODE	DIMENSIONS (mm)	GN 1/1 CAPACITY	DOORS TYPE	DOORS NUMBER	POWER (W)	CLIMATE CLASS	COLD GROUP	€	
COLD RESERVE												
	RF4-12 D	R452a	50	19047897	1145x766x450	GN 2/1	Swing	1	385	IV	Included	-
			60	19068241								-
	RF4-22 DD	R452a	50	19047898	1763x766x450	GN 2/1	Swing	2	405	IV	Included	-
			60	19068242								-
	RF4-21 DD	R452a	50	19056269	1370x676x450	GN 1/1	Swing	2	355	IV	Included	-
			60	19068245								-
	RF4-31 DDD	R452a	50	19056271	1763x676x450	GN 1/1	Swing	3	370	IV	Included	-
			60	19068246								-
HOT RESERVE												
	RCD4-09	-	50/60	19047891	1160x720x450	-	Sliding	-	850	-	-	-
	RCD4-11	-	50/60	19047892	1385x720x450	-	Sliding	-	850	-	-	-
	RCD4-15	-	50/60	19047893	1770x720x450	-	Sliding	-	1450	-	-	-
	RCD4-19	-	50/60	19047894	2120x720x450	-	Sliding	-	1690	-	-	-
COLD RESERVE ACCESSORIES												
	KCRF-12	-		19056266			Kit 2 drawers GN 2/1 to replace a door					-
	KCRF-11	-		19056247			Kit 2 drawers GN 1/1 to replace a door					-
COMMON ACCESSORIES												
	KPSR	-		19056083			Set of 4 legs (height 150 mm)					-

Available options

	FREQUENCY (HZ)	HEIGHT	MODELS TYPE	GN 1/1 CAPACITY	CLIMATE CLASS	COLD GROUP
COLD RESERVE	50-60	450-586	Swing doors - Drawers	GN 1/1 - GN 2/1	IV-V	Included- Remote
HOT RESERVE	-	450-610	-	-	-	-

Dispensers



General characteristics

- Specially designed to store and serve neutral plates, hot plates and universal ware washing baskets.
- Made of stainless steel.
- Special system with steel springs, keeping the plates and baskets at a constant level for easy service.
- Easy to place and remove.
- Capacity: 40/45 plates (according to thickness) and 5/6 baskets with a depth of 110 mm.





IDPN-28





IDPC-28 + ITDP-28



IDCN-55

MODEL	HZ	CODE	DIMENSIONS (mm)	CUT-OUT DIMENSIONS (mm)	Ø PLATE (mm)	PLATE CAPACITY	MAXIMUM LOAD (KG)	POWER(W)	€
NEUTRAL PLATE DISPENSER									
 IDPN-28	-	19046408	391x730	Ø375	from 180 to 280	40/45	45	-	-
IDPN-34	-	19043371	451x730	Ø434	from 240 to 340	40/45	45	-	-
HOT PLATE DISPENSER									
 IDPC-28	50/60	19043372	420x730	Ø407	from 180 to 280	40/45	45	480	-
IDPC-34	50/60	19043373	480x730	Ø466	from 240 to 340	40/45	45	480	-

MODEL	HZ	CODE	DIMENSIONS (mm)	DISPENSER	Ø PLATE (mm)	POWER (W)	€
COVER FOR PLATE DISPENSER							
 ITDP-28	-	19043374	Ø400x60	IDPC-28 - IDPN-28	from 180 to 280	-	-
ITDP-34	-	19043375	Ø400x60	IDPC-34 - IDPN-34	from 240 to 340	-	-

MODEL	HZ	CODE	DIMENSIONS (mm)	CUT-OUT DIMENSIONS (mm)	BASKET (mm)	BASKET CAPACITY	MAXIMUM LOAD (KG)	€
BASKET DISPENSER								
 IDCN-55		19043376	600x640x710	535x610	500 x 500	5/6	120	-

Vitrinas expositoras

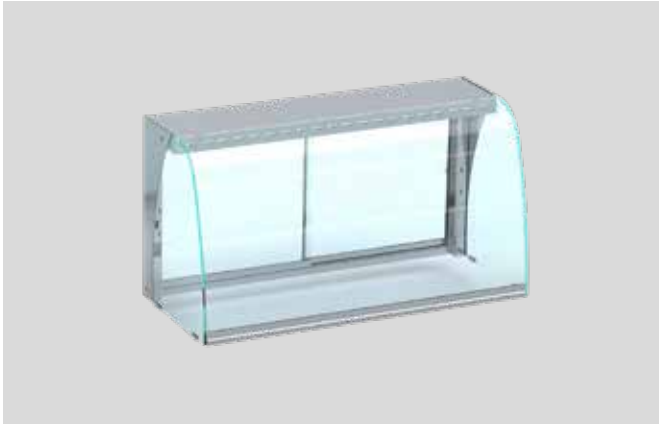

General characteristics

- Specially designed to be installed over Encastro drop-in elements or any type of worktop.
- Structure made of stainless steel with a fine satin finish.
- Glass-tempered sliding back doors and closed sides.
- Hot showcase with integrated halogen lamp to illuminate and generate heat over the entire display area.
- Showcase with light with integrated protected LED strips to illuminate the entire display area.
- Control panel with ON/OFF switch.



VEC-CE-4

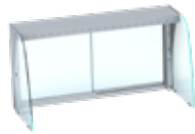

VEC-4



VE-CE-4



VE-EI-4



VE-CE-CB-EI-4

MODEL	HZ	CODE	DIMENSIONS (mm)	GN 1/1 CAPACITY	CUSTOMER SIDE	BASE	DESCRIPTION	POWER (W)	€
HOT SHOWCASE DISPLAY WITHOUT BASE									
 VEC-CE-3	50/60	19043234	1104x610x752	3	Closed	Without base	Light and heat	900	-
 VEC-CE-4	50/60	19043235	1430x610x752	4	Closed	Without base	Light and heat	1200	-
 VEC-3	50/60	19043237	1104x597x752	3	Open	Without base	Light and heat	900	-
 VEC-4	50/60	19043238	1430x597x752	4	Open	Without base	Light and heat	1200	-
CLOSED SHOWCASE DISPLAY WITH LIGHT NO BASE									
 VE-CE-3	50/60	19043240	1104x610x752	3	Closed	Without base	Light	35	-
 VE-CE-4	50/60	19043241	1430x610x752	4	Closed	Without base	Light	45	-
SHOWCASE DISPLAY WITH LIGHT AND INTERMEDIATE SHELF									
 VE-CE-CB-EI-3	50/60	19043243	1116x610x771	3	Closed	With base	Light	35	-
 VE-CE-CB-EI-4	50/60	19043244	1442x610x771	4	Closed	With base	Light	45	-
 VE-EI-3	50/60	19043246	1104x597x752	3	Open	Without base	Light	35	-
 VE-EI-4	50/60	19043247	1430x597x752	4	Open	Without base	Light	45	-
ACCESSORIES - INTERMEDIATE SHELF									
 EI-3	-	19043254	1070x348	3	Intermediate shelf for showcase displays VE-CE-3			-	-
 EI-4	-	19043255	1395x348	4	Intermediate shelf for showcase displays VE-CE-4			-	-

Available options

	GN 1/1 CAPACITY	CUSTOMER SIDE	BASE
HOT SHOWCASE DISPLAY WITHOUT BASE	2-3-4	Open - Closed	-
CLOSED SHOWCASE DISPLAY WITH LIGHT NO BASE	2-3-4	-	-
SHOWCASE DISPLAY WITH LIGHT INTERMEDIATE SHELF	2-3-4	Open - Closed	Without base - With base
ACCESSORIES - INTERMEDIATE SHELF	2-3-4	-	-

Accessories

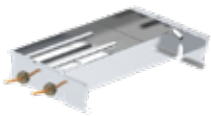

EV-KIT-450



OF-PAN















PAL-DROPIN



IPCTI



KUV-2/3/4

MODEL	HZ	CODE	DIMENSIONS (mm)	DESCRIPTION	POWER (W)	€
EVAPORATION KIT DEFROST WATER						
 EV-KIT-450	50/60	19046595	400x170x65	Ventilated wells and displays 3 GN1/1	450	-
 EV-KIT-900	50/60	19046596	400x170x65	Displays 4 GN1/1	900	-
 EV-KIT-1350	50/60	19046597	400x170x65	Displays 5 and 6 GN1/1	1350	-
OVERFLOW PAN DEFROST WATER						
 OF-PAN		19046598	GN 1/1 (65 mm height)	All refrigerated drop-in elements	-	-
TOOL TO LIFT DROP-IN						
 PAL-DROPIN		19046641	-	All drop-in elements	-	-
DIGITAL THERMOMETER KIT						
 IPCIC	50/60	19053060	132x84x70	Switch	1	-
 IPCTD	50/60	19053058	132x84x70	Thermometer cold elements	1	-
 IPCTI	50/60	19053061	132x84x70	Thermometer and switch cold elements	1	-
 IPCTD-C	50/60	19052024	132x84x70	Thermometer hot elements	1	-
 IPCTI-C	50/60	19055869	132x84x70	Thermometer and switch hot elements	1	-
GERMICIDAL LAMP						
 KUV-2/3/4	50/60	19079012	477x50x73	Ventilated wells / displays from 2 to 4 GN 1/1	25	-
 KUV-5/6	50/60	19079013	954x50x73	Ventilated wells / displays from 5 to 6 GN 1/1	50	-



**Flexibility to adapt
to all spaces with
ergonomics.**



Find out more!



Access the website



Il price list

Self Service

Dispensers	307
Neutral elements	309
Refrigerated elements	311
Refrigerated displays	313
Hot elements	315
Hot displays	317
Foodshields and Glasses	318
Accessories	323
Options.....	325

Dispensers



General characteristics

- Dispensers specially designed to store and distribute serving trays, cutlery pieces, bread rolls and / or glasses.
- Manufactured with a sturdy, high-quality, stainless steel structure.

Dispensers over a base

- 400 mm height, 1.5 mm thickness stainless steel worktop in satin finish.
- Front panels in water-resistant medium density fibreboard (MDF).
- Facade decoration with laminated panels. Decorated on four (4) sides.
- Decoration facade at 150 mm from the ground.



SS-77



D-R-313



D-R-613/2



DV-R-62



DVCP-R-6

MODEL	CODE	DIMENSIONS (mm)	DESCRIPTION	TRAY CAPACITY	CUTLERY CAPACITY	BREAD ROLL CAPACITY	GLASS CAPACITY (Ø80 mm // Ø75mm)	BRACKET	€	
TRAY DISPENSER										
	SS-77	18001483	798x780x400	2 Columns	160	-	-	-	-	
	SS-147	18001484	1450x780x400	4 Columns	320	-	-	-	-	
TRAY AND CUTLERY DISPENSER OVER A BASE										
	D-R-313	18003180	798x780x1514	3 GN 1/3 -150mm	160	150	-	Rectangular	-	
	D-R-613	18003190	1450x780x1514	6 GN 1/3 -150mm	320	300	-	Rectangular	-	
TRAY, CUTLERY AND BREAD DISPENSER OVER A BASE										
	D-R-313/2	18003191	798x780x1514	3 GN 1/3 - 150mm + 1 GN 2/1- 200mm	160	150	120	Rectangular	-	
	D-R-613/2	18003192	1450x780x1514	6 GN 1/3 - 150mm + 2 GN 2/1- 200mm	320	300	240	Rectangular	-	
GLASS DISPENSER OVER A BASE										
	DV-R-6	18003193	798x780x1569	6 glass levels	-	-	324/360	Rectangular	-	
	DV-R-8	18003194	798x780x1909	8 glass levels	-	-	432/480	Rectangular	-	
	DV-R-62	18003196	1450x780x1569	6 x 2 glass levels	-	-	648/720	Rectangular	-	
	DV-R-82	18003197	1450x780x1909	8 x 2 glass levels	-	-	864/960	Rectangular	-	
TRAY, CUTLERY, BREAD AND GLASS DISPENSER OVER A BASE										
	DVCP-R-6	18003199	1450x780x1569	3 GN 1/3 - 150 mm + 1 GN 2/1 - 200 mm + 6 glass levels	160	150	120	324/360	Rectangular	-



DC-R-2









DP-R-1



DV-R-4 SB



DV-R-4 SB

MODEL	CODE	DIMENSIONS (mm)	DESCRIPTION	CUTLERY CAPACITY	BREAD ROLL CAPACITY	GLASS CAPACITY (Ø80 mm // Ø75mm)	BRACKET	€	
CUTLERY DISPENSER OVER NEUTRAL ELEMENT									
	DC-R-1	19071811	696x345x536	3 GN 1/3 - 150 mm	150	-	Rectangular	-	
	DC-R-2	19071812	696x345x658	6 GN 1/3 - 150 mm	300	-	Rectangular	-	
BREAD DISPENSER OVER NEUTRAL ELEMENT									
	DP-R-1	19071813	696x667x600	1 GN 2/1 - 200 mm	-	120	Rectangular	-	
	DP-R-2	19071814	696x667x725	2 GN 2/1 - 200 mm	-	240	Rectangular	-	
CUTLERY AND BREAD DISPENSER OVER NEUTRAL ELEMENT									
	DCP-R	19071815	696x667x658	3 GN 1/3 - 150 mm + 1 GN 2/1 - 200 mm	150	120	Rectangular	-	
GLASS DISPENSER OVER NEUTRAL ELEMENT									
	DV-R-4 SB	19071816	696x745x829	4 glass levels	-	-	216/240	Rectangular	-

Available options

	BRACKET
TRAY AND CUTLERY DISPENSER OVER A BASE	Oblong-Rectangular
TRAY, CUTLERY AND BREAD DISPENSER OVER A BASE	Oblong-Rectangular
GLASS DISPENSER OVER A BASE	Oblong-Rectangular
TRAY, CUTLERY, BREAD AND GLASS DISPENSER OVER A BASE	Oblong-Rectangular
CUTLERY DISPENSER OVER NEUTRAL ELEMENT	Oblong-Rectangular
BREAD DISPENSER OVER NEUTRAL ELEMENT	Oblong-Rectangular
CUTLERY AND BREAD DISPENSER OVER NEUTRAL ELEMENT	Oblong-Rectangular
GLASS DISPENSER OVER NEUTRAL ELEMENT	Oblong-Rectangular

Neutral Elements



General characteristics

- Manufactured with a sturdy, high-quality, stainless steel structure.
- 900 mm height, 1.5 mm thickness stainless steel worktop in satin finish.
- 800 mm height tray slider. Made up of three (3) Ø 30 mm stainless steel round tubes.
- Food grade, waterproof, elastic, silicone joint placed between the worktops to ensure a precise adjustment.
- Front panels in water-resistant medium density fibreboard (MDF).
- Facade decoration with laminated panels.
- Decoration facade at 150 mm from the ground.



SM-4





SA-I-45



SA-E-90



SME-4

	MODEL	CODE	DIMENSIONS (mm)	DESCRIPTION	CAPACITY GN 1/1	€
NEUTRAL ELEMENT						
	SM-450	18001494	450x850x900	Closed without neutral reserve	-	-
	SM-2	18001495	950x850x900	Open / neutral reserve	2	-
	SM-3	18001496	1375x850x900	Open / neutral reserve	3	-
	SM-4	18001497	1600x850x900	Open / neutral reserve	4	-
	SM-5	18001498	1985x850x900	Open / neutral reserve	5	-
	SM-6	18001499	2335x850x900	Open / neutral reserve	6	-
	SM-3-P	18001500	1375x850x900	Neutral reserve with 2 sliding doors and 1 optional intermediate shelf	3	-
	SM-4-P	18001501	1600x850x900	Neutral reserve with 2 sliding doors and 1 optional intermediate shelf	4	-
	SM-5-P	18001502	1985x850x900	Neutral reserve with 2 sliding doors and 1 optional intermediate shelf	5	-
	SM-6-P	18001503	2335x850x900	Neutral reserve with 2 sliding doors and 1 optional intermediate shelf	6	-
CORNER ELEMENT						
	SA-I-90	18001504	1141x1141x900	90° internal angle. Open / neutral reserve	-	-
	SA-I-45	18001505	850x850x900	45° internal angle. Open / neutral reserve	-	-
	SA-E-90	18001506	935x935x900	90° external angle. Without neutral reserve	-	-
	SA-E-45	18001507	850x850x900	45° external angle. Without neutral reserve	-	-
SHO COOKING ELEMENT						
	SME-3	18001522	1375x850x900	200 mm recessed countertop. 3 single-phase power outlets	3	-
	SME-4	18001523	1600x850x900	200 mm recessed countertop. 4 single-phase power outlets	4	-
	SME-5	18001524	1985x850x900	200 mm recessed countertop. 5 single-phase power outlets	5	-
	SME-6	18001525	2335x850x900	200 mm recessed countertop. 5 single-phase power outlets	6	-



SMC-12-D



SMC-8-F



DAC-95



DPAN-95

MODEL	CODE	DIMENSIONS (mm)	DESCRIPTION	€
CASH REGISTER ELEMENT				
	SMC-12-D	18001514	1375x850x900 Cash register element with side arm to the right	-
	SMC-12-I	18001516	1375x850x900 Cash register element with side arm to the left	-
	SMC-16	18001518	1640x1030x900 Cash register element with both side arms (central)	-
	SMC-16-D	18001515	1600x850x900 Cash register element with side arm to the right	-
	SMC-16-I	18001517	1600x850x900 Cash register element with side arm to the left	-
	SMC-6-D	18001519	605x850x900 Cash register element without side arm (cash register to the right)	-
	SMC-6-I	18001520	605x850x900 Cash register element without side arm (cash register to the left)	-
	SMC-8-F	18001521	800x850x900 Cash register element without side arm (cash register facing public)	-

MODEL	CODE	DIMENSIONS (mm)	DESCRIPTION	PLATE CAPACITY (Ø280mm)	GLASS CAPACITY (Ø80//Ø75mm)	MAXIMUM LOAD (KG)	POWER (W)	€
PLATE DISPENSER								
	DAN-95	18001508	950x850x900 2 plate columns - neutral	80-90	-	45 per column	-	-
	DAC-95	18001509	950x850x900 2 plate columns - heated	80-90	-	45 per column	960	-
GLASS BASKET DISPENSER								
	DPAN-95	18001510	950x850x900 5/6 glass baskets	-	200 // 265	120	-	-

Refrigerated Elements



General characteristics

- Refrigerated elements specially designed to hold, display and serve chilled food during service time
- Counter framework manufactured with a sturdy, high-quality, full stainless steel structure.
- 900 mm height, 1.5 mm thickness stainless steel worktop in satin finish.
- 800 mm height tray slider. Made up of three (3) Ø 30 mm stainless steel round tubes.
- Food grade, waterproof, elastic, silicone joint placed between the worktops to ensure a precise adjustment.

- Front panels in water-resistant medium density fibreboard (MDF).
- Facade decoration with laminated panels.
- Decoration facade at 150 mm from the ground.
- Static well cooling system by expanded copper coil located on its base.
- Ventilated well cooling system creates a constant flow of chilled air, coming from

- the evaporator module fans.
- Polyurethane insulation with ecological injection, CFC-free, with high-density (40 kg/m³).
- Electronic thermostat with digital display. Deferred start-up function.
- Electrical components in a single, easy-access point to enable maintenance operations.

- Junction box housing electrical connections providing a centralized access of all technical powered elements.
- Plinths or any other accessories should be requested separately and are supplied disassembled.



SCR-SR-30-4



SCR-CR-30-4

MODEL	GAS	HZ	CODE	DIMENSIONS (mm)	WELL DEPTH(mm)	CAPACITY GN 1/1	RESERVE	POWER (W)	CLIMATE CLASS	COLD GROUP	€
STATIC REFRIGERATED WELL ELEMENT											
SCR-SR-30-3	R452a	50	18001526	1375x850x900	30	3	Open / neutral reserve	220	IV	Included	-
 SCR-SR-30-4	R452a	50	18001527	1600x850x900	30	4	Open / neutral reserve	335	IV	Included	-
SCR-SR-30-5	R452a	50/60	18001528	1985x850x900	30	5	Open / neutral reserve	380	IV	Included	-
SCR-SR-30-6	R452a	50/60	18001529	2335x850x900	30	6	Open / neutral reserve	390	IV	Included	-
SCR-CR-30-3	R452a	50	18001530	1375x850x900	30	3	1 x GN2/1 refrigerated reserve	570	IV	Included	-
 SCR-CR-30-4	R452a	50	18001531	1600x850x900	30	4	1 x GN2/1 refrigerated reserve	685	IV	Included	-
SCR-CR-30-5	R452a	50/60	18001532	1985x850x900	30	5	2 x GN2/1 refrigerated reserve	910	IV	Included	-
SCR-CR-30-6	R452a	50/60	18001533	2335x850x900	30	6	2 x GN2/1 refrigerated reserve	920	IV	Included	-



SCV-SR-4



SCNH-80-4



SCR-4



SCV-4

MODEL	GAS	HZ	CODE	DIMENSIONS (mm)	WELL DEPTH(mm)	CAPACITY GN 1/1	RESERVE	POWER (W)	CLIMATE CLASS	COLD GROUP	€	
VENTILATED REFRIGERATED WELL ELEMENT												
	SCV-SR-3	R452a	50/60	18001542	1375x850x900	30-75-115	3	Open / neutral reserve	395	IV	Included	-
	SCV-SR-4	R452a	50/60	18001543	1600x850x900	30-75-115	4	Open / neutral reserve	535	IV	Included	-
	SCV-SR-5	R452a	50/60	18001544	1985x850x900	30-75-115	5	Open / neutral reserve	710	IV	Included	-
	SCV-SR-6	R452a	50/60	18001545	2335x850x900	30-75-115	6	Open / neutral reserve	780	IV	Included	-
	SCV-CR-3	R452a	50	18001546	1375x850x900	30-75-115	3	1 x GN2/1 refrigerated reserve	780	IV	Included	-
	SCV-CR-4	R452a	50	18001547	1600x850x900	30-75-115	4	1 x GN2/1 refrigerated reserve	920	IV	Included	-
	SCV-CR-5	R452a	50	18001548	1985x850x900	30-75-115	5	2 x GN2/1 refrigerated reserve	1115	IV	Included	-
	SCV-CR-6	R452a	50	18001549	2335x850x900	30-75-115	6	2 x GN2/1 refrigerated reserve	1185	IV	Included	-
ISLAND-TYPE NEUTRAL ICE WELL ELEMENT												
	SCNH-80-3	-	-	18001663	1265x875x900	80	3	-	-	-	-	-
	SCNH-80-4	-	-	18001664	1590x875x900	80	4	-	-	-	-	-
	SCNH-80-5	-	-	18001665	1975x875x900	80	5	-	-	-	-	-
	SCNH-80-6	-	-	18001666	2325x875x900	80	6	-	-	-	-	-
ISLAND-TYPE STATIC REFRIGERATED WELL ELEMENT												
	SCR-3	R452a	50	18001594	1265x875x900	80	3	-	220	IV	Included	-
	SCR-4	R452a	50	18001595	1590x875x900	80	4	-	335	IV	Included	-
	SCR-5	R452a	50/60	18001596	1975x875x900	80	5	-	380	IV	Included	-
	SCR-6	R452a	50/60	18001597	2325x875x900	80	6	-	390	IV	Included	-
ISLAND-TYPE VENTILATED REFRIGERATED WELL ELEMENT												
	SCV-3	R452a	50/60	18001598	1265x875x900	30-75-115	3	-	395	IV	Included	-
	SCV-4	R452a	50/60	18001599	1590x875x900	30-75-115	4	-	535	IV	Included	-
	SCV-5	R452a	50/60	18001600	1975x875x900	30-75-115	5	-	710	IV	Included	-
	SCV-6	R452a	50/60	18001601	2325x875x900	30-75-115	6	-	780	IV	Included	-

Available options

	FREQUENCY HZ	WELL DEPTH (mm)	RESERVE	CLIMATE CLASS	COLD GROUP
STATIC REFRIGERATED WELL ELEMENT	50-60	30 - 80	Open - Neutral - Refrigerated	IV - V	Included - Remote
VENTILATED REFRIGERATED WELL ELEMENT	50-60	-	Open - Neutral - Refrigerated	IV - V	Included - Remote
ISLAND-TYPE NEUTRAL ICE WELL ELEMENT*	-	80 - 120	-	-	-
ISLAND-TYPE STATIC REFRIGERATED WELL ELEMENT	50-60	-	-	IV - V	Included - Remote
ISLAND-TYPE VENTILATED REFRIGERATED WELL ELEMENT	50-60	-	-	IV - V	Included - Remote

*120 mm depth neutral ice well includes RGB LED at the bottom.

Refrigerated Displays



General characteristics

- Refrigerated displays specially designed to hold, display and serve chilled food and beverages during service time.
- Counter framework manufactured with a sturdy, high-quality, full stainless steel structure.
- 900 mm height, 1.5 mm thickness stainless steel worktop in satin finish.
- 800 mm height tray slider. Made up of three (3) Ø 30 mm stainless steel round tubes.
- Food grade, waterproof, elastic, silicone joint placed between the worktops to ensure a precise adjustment.
- Front panels in water-resistant medium density fibreboard (MDF).



- Facade decoration with laminated panels.
- Decoration facade at 150 mm from the ground.
- Ventilated display cooling system creates a constant flow of chilled air at the back side of the display coming from the evaporator module fans.
- Polyurethane insulation with ecological injection, CFC-free, with high-density (40 kg/m³).
- 8 mm thickness tempered glass shelves.
- Back display doors allowing an easy product access.
- 4500°K pure white LED light strips, integrated on the display.
- Electronic thermostat with digital display. Deferred start-up function.
- Electrical components in a single, easy-access point to enable maintenance operations.
- Junction box housing electrical connections providing a centralized access of all technical powered elements.
- Plinths or any other accessories should be requested separately and are supplied disassembled.



VCR-SR-CT-4



VCR-CR-CT-4



MODEL	GAS	HZ	CODE	DIMENSIONS (mm)	CAPACITY GN 1/1	RESERVE	CUSTOMER SIDE	SERVICE SIDE	POWER (W)	CLIMATE CLASS	COLD GROUP	€
3-LEVEL CUBIC VENTILATED REFRIGERATED DISPLAY												
VCR-SR-CT-3	R452a	50	18001550	1375x850x1665	3	Open / neutral reserve	Curtain	Swing doors	885	III	Included	-
 VCR-SR-CT-4	R452a	50	18001551	1600x850x1665	4	Open / neutral reserve	Curtain	Swing doors	1190	III	Included	-
VCR-SR-CT-5	R452a	50	18001552	1985x850x1665	5	Open / neutral reserve	Curtain	Swing doors	1460	III	Included	-
VCR-SR-CT-6	R452a	50	18001553	2335x850x1665	6	Open / neutral reserve	Curtain	Swing doors	1930	III	Included	-
VCR-CR-CT-3	R452a	50	18001558	1375x850x1665	3	1 GN2/1 refrigerated reserve	Curtain	Swing doors	1270	III	Included	-
 VCR-CR-CT-4	R452a	50	18001559	1600x850x1665	4	1 GN2/1 refrigerated reserve	Curtain	Swing doors	1575	III	Included	-
VCR-CR-CT-5	R452a	50	18001560	1985x850x1665	5	1 GN2/1 refrigerated reserve	Curtain	Swing doors	1865	III	Included	-
VCR-CR-CT-6	R452a	50	18001561	2335x850x1665	6	1 GN2/1 refrigerated reserve	Curtain	Swing doors	2335	III	Included	-



VCR-SR-CP-4



VCR-SC-CP-4

MODEL	GAS	HZ	CODE	DIMENSIONS (mm)	CAPACITY GN 1/1	RESERVE	CUSTOMER SIDE	SERVICE SIDE	POWER (W)	CLIMATE CLASS	COLD GROUP	€
4-LEVEL CUBIC VENTILATED REFRIGERATED DISPLAY												
VCR-SR-CP-4-3	R452a	50	18001570	1375x850x2105	3	Open / neutral reserve	Blinds	Swing doors	915	III	Included	-
 VCR-SR-CP-4-4	R452a	50	18001571	1600x850x2105	4	Open / neutral reserve	Blinds	Swing doors	1210	III	Included	-
VCR-SR-CP-4-5	R452a	50	18001572	1985x850x2105	5	Open / neutral reserve	Blinds	Swing doors	1490	III	Included	-
VCR-SR-CP-4-6	R452a	50	18001573	2335x850x2105	6	Open / neutral reserve	Blinds	Swing doors	1960	III	Included	-
VCR-CR-CP-4-3	R452a	50	18001578	1375x850x2105	3	1 GN2/1 refrigerated reserve	Blinds	Swing doors	1300	III	Included	-
 VCR-CR-CP-4-4	R452a	50	18001579	1600x850x2105	4	1 GN2/1 refrigerated reserve	Blinds	Swing doors	1605	III	Included	-
VCR-CR-CP-4-5	R452a	50	18001580	1985x850x2105	5	1 GN2/1 refrigerated reserve	Blinds	Swing doors	1895	III	Included	-
VCR-CR-CP-4-6	R452a	50	18001581	2335x850x2105	6	1 GN2/1 refrigerated reserve	Blinds	Swing doors	2365	III	Included	-

Available options

	FREQUENCY HZ	CUSTOMER SIDE	RESERVE	CLIMATE CLASS	COLD GROUP
3-LEVEL CUBIC VENTILATED REFRIGERATED DISPLAY	50-60	Curtain - Blinds	Open - Neutral - Refrigerated	III - IV	Included - Remote
4-LEVEL CUBIC VENTILATED REFRIGERATED DISPLAY	50-60	Curtain - Blinds	Open - Neutral - Refrigerated	III - IV	Included - Remote

Hot Elements



General characteristics

- Hot elements specially designed to hold, display and serve hot food during service time
- Counter framework manufactured with a sturdy, high-quality, full stainless steel structure.
- 900 mm height, 1.5 mm thickness stainless steel worktop in satin finish.
- 800 mm height tray slider. Made up of three (3) Ø 30 mm stainless steel round tubes.
- Food grade, waterproof, elastic, silicone joint placed between the worktops to ensure a precise adjustment.
- Front panels in water-resistant medium density fibreboard (MDF).

- Facade decoration with laminated panels.
- Decoration facade at 150 mm from the ground.
- Glass ceramic / stainless steel top heating system by hidden silicon resistors attached to the bottom of the plate / worktop.
- Dry bain marie heating system by a set of resistor modules with fans.

- Wet bain marie heating system by hidden silicon resistors attached to the bottom of the well.
- Electronic thermostat with digital display. Deferred start-up function.
- Electrical components in a single, easy-access point to enable maintenance operations.



- Junction box housing electrical connections providing a centralized access of all technical powered elements.
- Plinths or any other accessories should be requested separately and are supplied disassembled.



SI-SR-4



SV-SR-4

MODEL	VOLTAGE AND FREQUENCY (HZ)	CODE	DIMENSIONS (mm)	CAPACITY GN 1/1	RESERVE	POWER(W)	€
STAINLESS STEEL HOT WORKTOP ELEMENT							
SI-SR-3	230V 1N 50/60	18001602	1375x850x900	3	Open / neutral reserve	450	-
 SI-SR-4	230V 1N 50/60	18001603	1600x850x900	4	Open / neutral reserve	675	-
SI-SR-5	230V 1N 50/60	18001604	1985x850x900	5	Open / neutral reserve	675	-
SI-SR-6	230V 1N 50/60	18001605	2335x850x900	6	Open / neutral reserve	675	-
SI-CR-3	230V 1N 50/60	18001606	1375x850x900	3	Hot reserve	1895	-
 SI-CR-4	230V 1N 50/60	18001607	1600x850x900	4	Hot reserve	1895	-
SI-CR-5	230V 1N 50/60	18001608	1985x850x900	5	Hot reserve	3120	-
SI-CR-6	230V 1N 50/60	18001609	2335x850x900	6	Hot reserve	3575	-
GLASS CERAMIC PLATE HOT ELEMENT							
SV-SR-2	230V 1N 50/60	18001658	950x850x900	2	Open / neutral reserve	905	-
 SV-SR-3	230V 1N 50/60	18001610	1375x850x900	3	Open / neutral reserve	1355	-
SV-SR-4	230V 1N 50/60	18001611	1600x850x900	4	Open / neutral reserve	1805	-
SV-SR-5	230V 1N 50/60	18001612	1985x850x900	5	Open / neutral reserve	2255	-
SV-SR-6	230V 1N 50/60	18001613	2335x850x900	6	Open / neutral reserve	2710	-
SV-CR-3	230V 1N 50/60	18001614	1375x850x900	3	Hot reserve	2805	-
 SV-CR-4	230V 1N 50/60	18001615	1600x850x900	4	Hot reserve	3255	-
SV-CR-5	400V 3N 50/60	18001616	1985x850x900	5	Hot reserve	4275	-
SV-CR-6	400V 3N 50/60	18001617	2335x850x900	6	Hot reserve	5710	-





SBM-SR-4



SBMV-SR-4



SV-4

MODEL	VOLTAGE AND FREQUENCY (HZ)	CODE	DIMENSIONS (mm)	WELL DEPTH(mm)	CAPACITY GN 1/1	RESERVE	POWER(W)	€
WET BAIN MARIE HOT ELEMENT								
SBM-SR-2	230V 1N 50/60	18001618	950x850x900	190	2	Open / neutral reserve	1510	-
SBM-SR-3	230V 1N 50/60	18001619	1375x850x900	190	3	Open / neutral reserve	2005	-
 SBM-SR-4	230V 1N 50/60	18001620	1600x850x900	190	4	Open / neutral reserve	2510	-
SBM-SR-5	230V 1N 50/60	18001621	1985x850x900	190	5	Open / neutral reserve	3030	-
SBM-SR-6	230V 1N 50/60	18001622	2335x850x900	190	6	Open / neutral reserve	3555	-
SBM-CR-3	230V 1N 50/60	18001623	1375x850x900	190	3	Hot reserve	2905	-
 SBM-CR-4	400V 3N 50/60	18001624	1600x850x900	190	4	Hot reserve	3360	-
SBM-CR-5	400V 3N 50/60	18001625	1985x850x900	190	5	Hot reserve	4480	-
SBM-CR-6	400V 3N 50/60	18001626	2335x850x900	190	6	Hot reserve	5245	-
DRY BAIN MARIE HOT ELEMENT								
SBMV-SR-3	230V 1N 50/60	18001627	1375x850x900	210	3	Open / neutral reserve	1550	-
 SBMV-SR-4	230V 1N 50/60	18001628	1600x850x900	210	4	Open / neutral reserve	2050	-
SBMV-SR-5	230V 1N 50/60	18001629	1985x850x900	210	5	Open / neutral reserve	3080	-
SBMV-SR-6	230V 1N 50/60	18001630	2335x850x900	210	6	Open / neutral reserve	3120	-
SBMV-CR-3	230V 1N 50/60	18001631	1375x850x900	210	3	Hot reserve	2400	-
 SBMV-CR-4	230V 1N 50/60	18001632	1600x850x900	210	4	Hot reserve	2900	-
SBMV-CR-5	400V 3N 50/60	18001633	1985x850x900	210	5	Hot reserve	4530	-
SBMV-CR-6	400V 3N 50/60	18001634	2335x850x900	210	6	Hot reserve	4810	-
ISLAND-TYPE GLASS CERAMIC PLATE HOT ELEMENT								
SV-3	230V 1N 50/60	18001643	1265x875x900	-	3	-	1355	-
 SV-4	230V 1N 50/60	18001644	1590x875x900	-	4	-	1805	-
SV-5	230V 1N 50/60	18001645	1975x850x900	-	5	-	2255	-
SV-6	230V 1N 50/60	18001646	2325x875x900	-	6	-	2710	-

Available options

	RESERVE	WATER FILLING TYPE
STAINLESS STEEL HOT WORKTOP ELEMENT	Open - Neutral - Hot	-
GLASS CERAMIC PLATE HOT ELEMENT	Open - Neutral - Hot	-
WET BAIN MARIE HOT ELEMENT	Open - Neutral - Hot	Manual - Automatic
DRY BAIN MARIE HOT ELEMENT	Open - Neutral - Hot	-
ISLAND-TYPE GLASS CERAMIC PLATE HOT ELEMENT	-	-
ISLAND-TYPE WET BAIN MARIE HOT ELEMENT	-	Manual - Automatic

Hot Displays



General characteristics

- Hot displays specially designed to hold, display and serve hot food during service time
- Counter framework manufactured with a sturdy, high-quality, full stainless steel structure.
- 900 mm height, 1.5 mm thickness stainless steel worktop in satin finish.
- 800 mm height tray slider. Made up of three (3) Ø 30 mm stainless steel round tubes.
- Food grade, waterproof, elastic, silicone joint placed between the worktops to ensure a precise adjustment.
- Front panels in water-resistant medium density fibreboard (MDF).

- Facade decoration with laminated panels.
- Decoration facade at 150 mm from the ground.
- Hot display heating system by hidden silicon resistors attached to the bottom of the glass ceramic plate and shelf.
- Sliding back display doors allowing an easy product access. Open in the customer side.

- Dual-Heat system with light and heat foodshields located over the glass ceramic plate and shelf. Lighting by protected halogen lamps. Heating by infrared high-temperature ceramic elements.
- Two (2) electronic thermostats, with digital display, to control and regulate the temperature on the glass ceramic plate and on the shelf separately. Deferred start-up function.



- Electrical components in a single, easy-access point to enable maintenance operations.
- Junction box housing electrical connections providing a centralized access of all technical powered elements.
- Plinths or any other accessories should be requested separately and are supplied disassembled.



VCC-SR-2-4



VCC-CR-2-4

MODEL	VOLTAGE AND FREQUENCY (HZ)	CODE	DIMENSIONS (mm)	CAPACITY GN 1/1	RESERVE	CUSTOMER SIDE	SERVICE SIDE	POWER(W)	€	
CUBIC HOT GLASS CERAMIC DISPLAY										
	VCC-SR-2-3	400V 3N 50/60	18001635	1375x850x1665	3	Open / neutral reserve	Open	Sliding doors	4025	-
	VCC-SR-2-4	400V 3N 50/60	18001636	1600x850x1665	4	Open / neutral reserve	Open	Sliding doors	4700	-
	VCC-SR-2-5	400V 3N 50/60	18001637	1985x850x1665	5	Open / neutral reserve	Open	Sliding doors	6035	-
	VCC-SR-2-6	400V 3N 50/60	18001638	2335x850x1665	6	Open / neutral reserve	Open	Sliding doors	7450	-
	VCC-CR-2-3	400V 3N 50/60	18001639	1375x850x1665	3	Hot reserve	Open	Sliding doors	5475	-
	VCC-CR-2-4	400V 3N 50/60	18001640	1600x850x1665	4	Hot reserve	Open	Sliding doors	6150	-
	VCC-CR-2-5	400V 3N 50/60	18001641	1985x850x1665	5	Hot reserve	Open	Sliding doors	8505	-
	VCC-CR-2-6	400V 3N 50/60	18001642	2335x850x1665	6	Hot reserve	Open	Sliding doors	10450	-

Foodshields and Glasses



General characteristics

- Foodshields specially designed to improve food hygiene as well as to guarantee guest protection.
- Brackets manufactured in stainless steel, in oblong or rectangular tube.
- 35 mm distance between bracket and foodshield to make cleaning operations easier.
- Brackets are easily mounted on the structure by means of threaded plates.
- Straight or curved tempered glasses.
- Easy installation of glasses to foodshields by means of clamps.



IPLS-R-4



IPCS-R-4



IPCS-R-4 C



ISPPCS-R

	MODEL	HZ	CODE	DIMENSIONS (mm)	CAPACITY GN 1/1	FUNCTION	LEVEL	BRACKET	POWER (W)	€
FOODSHIELD WITH LIGHT										
	IPLS-R-2	50/60	19071983	764x142x426	2	Light	1 Level	Rectangular	15	-
	IPLS-R-3	50/60	19071984	1089x142x426	3	Light	1 Level	Rectangular	25	-
	IPLS-R-4	50/60	19071985	1414x142x426	4	Light	1 Level	Rectangular	35	-
	IPLS-R-5	50/60	19071986	1739x142x426	5	Light	1 Level	Rectangular	45	-
	IPLS-R-6	50/60	19071988	2064x142x426	6	Light	1 Level	Rectangular	55	-
	FOODSHIELD WITH HALOGEN HEAT									
	IPCS-R-2	50/60	19072011	764x142x426	2	Light and heat	1 Level	Rectangular	600	-
	IPCS-R-3	50/60	19072012	1089x142x426	3	Light and heat	1 Level	Rectangular	900	-
	IPCS-R-4	50/60	19072013	1414x142x426	4	Light and heat	1 Level	Rectangular	1200	-
	IPCS-R-5	50/60	19072014	1739x142x426	5	Light and heat	1 Level	Rectangular	1500	-
	IPCS-R-6	50/60	19072015	2064x142x426	6	Light and heat	1 Level	Rectangular	1500	-
	FOODSHIELD WITH CERAMIC HEAT									
	IPCS-R-2 C	50/60	19072016	764x142x426	2	Light and ceramic heat	1 Level	Rectangular	600	-
	IPCS-R-3 C	50/60	19072017	1089x142x426	3	Light and ceramic heat	1 Level	Rectangular	1050	-
	IPCS-R-4 C	50/60	19072018	1414x142x426	4	Light and ceramic heat	1 Level	Rectangular	1300	-
	IPCS-R-5 C	50/60	19072019	1739x142x426	5	Light and ceramic heat	1 Level	Rectangular	1650	-
	IPCS-R-6 C	50/60	19072021	2064x142x426	6	Light and ceramic heat	1 Level	Rectangular	1650	-
	NEUTRAL BRACKET									
	ISPPCS-R		19071964	68x85x426	-	Neutral	1 Level	Rectangular	-	-
	ISPPCS-R-2		19071966	68x85x676	-	Neutral	2 Levels	Rectangular	-	-





ICC-R-4-1C



ICC-R-4-2C



ICCS-R-FP-4

MODEL	CODE	DIMENSIONS (mm)	CAPACITY GN 1/1	GLASS SHAPE	€	
FRONTAL GLASS						
	ICC-R-2 1C	19043293	675x433x123	2	Straight	-
	ICC-R-3 1C	19043295	1000x433x123	3	Straight	-
	ICC-R-4 1C	19043296	1325x433x123	4	Straight	-
	ICC-R-5 1C	19043297	1650x433x123	5	Straight	-
	ICC-R-6 1C	19047843	1975x433x123	6	Straight	-
CENTRAL GLASS						
	ICC-R-2 2C	19043298	675x585x123	2	Straight	-
	ICC-R-3 2C	19043301	1000x585x123	3	Straight	-
	ICC-R-4 2C	19043302	1325x585x123	4	Straight	-
	ICC-R-5 2C	19043303	1650x585x123	5	Straight	-
	ICC-R-6 2C	19047844	1975x585x123	6	Straight	-
CLOSED FRONTAL GLASS						
	ICCS-R-FP-2	19072075	675x433x420	2	Straight	-
	ICCS-R-FP-3	19072076	1000x433x420	3	Straight	-
	ICCS-R-FP-4	19072077	1325x433x420	4	Straight	-
	ICCS-R-FP-5	19072078	1650x433x420	5	Straight	-
	ICCS-R-FP-6	19072079	1975x433x420	6	Straight	-

Available options

	NUMBER OF LEVELS	GLASS SHAPE	BRACKET
FOODSHIELD WITH LIGHT	1 - 2	-	Oblong - Rectangular
FOODSHIELD WITH HALOGEN HEAT	-	-	Oblong - Rectangular
FOODSHIELD WITH CERAMIC HEAT	-	-	Oblong - Rectangular
NEUTRAL BRACKET	1 - 2	-	Oblong - Rectangular
FRONTAL GLASS	-	Curved - Straight	-
CENTRAL GLASS	-	Curved - Straight	-
CLOSED FRONTAL GLASS	-	Curved - Straight	-

Foodshield with shelf and protection frontal glass

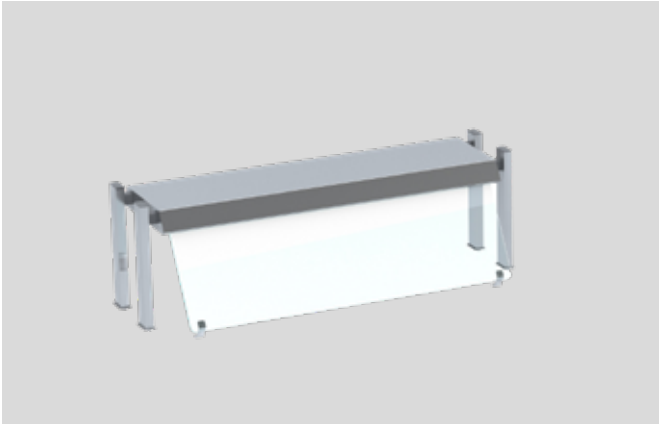

General characteristics

- Foodshields specially designed to improve food hygiene as well as to guarantee guest protection.
- Stainless steel shelf.
- Brackets manufactured in stainless steel, in oblong or rectangular tube.
- 35 mm distance between bracket and foodshield to make cleaning operations easier.
- Brackets are easily mounted on the structure by means of threaded plates.
- Easy installation of glasses to foodshields by means of clamps.

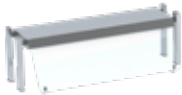



ECR-4



ECR-LC-4



ECR-LC-4 C

MODEL	HZ	CODE	DIMENSIONS (mm)	CAPACITY GN 1/1	FUNCTION	TYPE	BRACKET	POWER (W)	€	
NEUTRAL FOODSHIELD WITH STAINLESS STEEL SHELF AND PROTECTION FRONTAL GLASS										
	ECR-2	-	19056248	764x540x446	2	Neutral	Stainless steel shelf	Rectangular	-	-
	ECR-3	-	19056249	1089x540x446	3	Neutral	Stainless steel shelf	Rectangular	-	-
	ECR-4	-	19056250	1414x540x446	4	Neutral	Stainless steel shelf	Rectangular	-	-
	ECR-5	-	19056251	1739x540x446	5	Neutral	Stainless steel shelf	Rectangular	-	-
	ECR-6	-	19056252	2064x540x446	6	Neutral	Stainless steel shelf	Rectangular	-	-
LIGHT AND HALOGEN HEAT FOODSHIELD WITH STAINLESS STEEL SHELF AND PROTECTION FRONTAL GLASS										
	ECR-LC-2	50/60	19056261	764x540x446	2	Light and heat	Stainless steel shelf	Rectangular	600	-
	ECR-LC-3	50/60	19056262	1089x540x446	3	Light and heat	Stainless steel shelf	Rectangular	900	-
	ECR-LC-4	50/60	19056263	1414x540x446	4	Light and heat	Stainless steel shelf	Rectangular	1200	-
	ECR-LC-5	50/60	19056264	1739x540x446	5	Light and heat	Stainless steel shelf	Rectangular	1500	-
	ECR-LC-6	50/60	19056265	2064x540x446	6	Light and heat	Stainless steel shelf	Rectangular	1500	-
LIGHT AND CERAMIC HEAT FOODSHIELD WITH STAINLESS STEEL SHELF AND PROTECTION FRONTAL GLASS										
	ECR-LC-2 C	50/60	19071819	764x540x446	2	Light and ceramic heat	Stainless steel shelf	Rectangular	600	-
	ECR-LC-3 C	50/60	19071820	1089x540x446	3	Light and ceramic heat	Stainless steel shelf	Rectangular	1050	-
	ECR-LC-4 C	50/60	19071821	1414x540x446	4	Light and ceramic heat	Stainless steel shelf	Rectangular	1300	-
	ECR-LC-5 C	50/60	19071822	1739x540x446	5	Light and ceramic heat	Stainless steel shelf	Rectangular	1650	-
	ECR-LC-6 C	50/60	19071823	2064x540x446	6	Light and ceramic heat	Stainless steel shelf	Rectangular	1650	-



SCP-R-4



SCPP-R-4

	MODEL	CODE	DIMENSIONS (mm)	CAPACITY GN 1/1	FUNCTION	TYPE	BRACKET	NUMBER OF BRACKETS	€
NEUTRAL FOODSHIELD WITH VERTICAL PROTECTION GLASS									
	SCP-R-2	19056934	778x70x420	2	Neutral	Without passing plate platform	Rectangular	2	-
	SCP-R-3	19056874	1103x70x420	3	Neutral	Without passing plate platform	Rectangular	2	-
	SCP-R-4	19056875	1428x70x420	4	Neutral	Without passing plate platform	Rectangular	2	-
	SCP-R-5	19056877	1753x70x420	5	Neutral	Without passing plate platform	Rectangular	3	-
	SCP-R-6	19056878	2078x70x420	6	Neutral	Without passing plate platform	Rectangular	3	-
NEUTRAL FOODSHIELD WITH PASSING PLATE PLATFORM AND VERTICAL PROTECTION GLASS									
	SCPP-R-2	18001812	778x270x420	2	Neutral	With passing plate platform	Rectangular	2	-
	SCPP-R-3	18001805	1103x270x420	3	Neutral	With passing plate platform	Rectangular	2	-
	SCPP-R-4	18001806	1428x270x420	4	Neutral	With passing plate platform	Rectangular	2	-
	SCPP-R-5	18001807	1753x270x420	5	Neutral	With passing plate platform	Rectangular	3	-
	SCPP-R-6	18001809	2078x270x420	6	Neutral	With passing plate platform	Rectangular	3	-

Available options

	BRACKET
NEUTRAL FOODSHIELD WITH STAINLESS STEEL SHELF AND PROTECTION FRONTAL GLASS	Oblong - Rectangular
LIGHT AND HALOGEN HEAT FOODSHIELD WITH STAINLESS STEEL SHELF AND PROTECTION FRONTAL GLASS	Oblong - Rectangular
LIGHT AND CERAMIC HEAT FOODSHIELD WITH STAINLESS STEEL SHELF AND PROTECTION FRONTAL GLASS	Oblong - Rectangular
NEUTRAL FOODSHIELD WITH VERTICAL PROTECTION GLASS	Oblong - Rectangular
NEUTRAL FOODSHIELD WITH PASSING PLATE PLATFORM AND VERTICAL PROTECTION GLASS	Oblong - Rectangular

Accessories



ESN-4



ES-I-90



CJL-1



ITDP-28

Neutral elements accessories

MODEL	CODE	DIMENSIONS (mm)	DESCRIPTION	€	
NEUTRAL ELEMENTS ACCESSORIES					
	ESN-2	19037886	644x670	Height-adjustable shelf for SM-2	-
	ESN-3	19037883	1068x670	Height-adjustable shelf for SM-3	-
	ESN-4	19037884	1294x670	Height-adjustable shelf for SM-4	-
	ESN-5	19037885	1679x670	Height-adjustable shelf for SM-5	-
	ESN-6	19042746	2029x670	Height-adjustable shelf for SM-6	-
	ESN-3-P	19070426	1068x670	Height-adjustable shelf for SM-3-P	-
	ESN-4-P	19070427	1294x670	Height-adjustable shelf for SM-4-P	-
	ESN-5-P	19070428	1679x670	Height-adjustable shelf for SM-5-P	-
	ESN-6-P	19070429	2029x670	Height-adjustable shelf for SM-6-P	-
CORNER ELEMENTS ACCESSORIES					
	ES-I-45	19037895	578x530	Height-adjustable shelf for SA-I-45	-
	ES-I-90	19037894	1162x591	Height-adjustable shelf for SA-I-90	-
CASH REGISTER ELEMENTS ACCESSORIES					
	CJL-1	19046593	311x401x111	Drawer with lock for SMC-16, SMC-6-D, SMC-6-I, SMC-8-F	-
	CJL-2	19046594	311x401x111	Drawer with lock for SMC-12-D, SMC-12-I, SMC-16-D, SMC-16-I	-
PLATE DISPENSERS ACCESSORIES					
	ITDP-28	19043374	Ø 400x60	Lid covers for plate dispenser with Ø 280 mm	-

Accessories



EV-KIT-450









OF-PAN



PAL-DROPIN

Refrigerated elements accessories

MODEL	CODE	DIMENSIONS (mm)	DESCRIPTION	POWER (W)	€	
ACCESSORIES FOR REFRIGERATED ELEMENTS, ISLANDS AND DISPLAYS						
	ESF-3	19046585	534x670	Height-adjustable shelf for 3 GN 1/1	-	-
	ESF-4	19046586	759x670	Height-adjustable shelf for 4 GN 1/1	-	-
	ESF-5/6	19046587	1144x670	Height-adjustable shelf for 5 o 6 GN 1/1	-	-
	SP-70	19043113	680x250x170	Stainless steel plate rack shelf for island-type elements	-	-
PANS AND OTHER ACCESSORIES FOR REFRIGERATED ELEMENTS						
	EV-KIT-450	19046595	400x170x65	Evaporation kit defrost water for all ventilated elements and 3 GN 1/1 ventilated displays	450	-
	EV-KIT-900	19046596	400x170x65	Evaporation kit defrost water for 4 GN 1/1 refrigerated displays	900	-
	EV-KIT-1350	19046597	400x170x65	Evaporation kit defrost water for 5 GN 1/1 refrigerated displays	1350	-
	OF-PAN	19046598	GN 1/1-150 mm	Overflow pan for defrost water	-	-
	KUV-2/3/4	19079012	477x50x73	Germidal lamp for ventilated wells and displays from 2 to 4 GN 1/1	25	-
	KUV-5/6	19079013	954x50x73	Germidal lamp for ventilated wells and displays from 5 to 6 GN 1/1	50	-
	PAL-DROPIN	19046641	-	Tool to lift technical elements	-	-

Hot elements accessories

MODEL	VOLTAGE AND FREQUENCY (HZ)	CODE	DIMENSIONS (mm)	DESCRIPTION	POWER (W)	€	
UNDERCOUNTER HOT TROLLEYS							
	ICCB-6	230V 1N 50-60	19043639	685x670x730	1 door. Capacity 6 GN 2/1 guides.	850	-
	ICCB-6-3C	230V 1N 50-60	19043641	685x670x730	3 drawers. Capacity 3 GN 1/1 pans.	850	-
HOT ELEMENTS ACCESSORIES							
	ESC-2	-	19046588	412x670	Height-adjustable shelf for 2 GN 1/1	-	-
	ESC-3	-	19046589	837x670	Height-adjustable shelf for 3 GN 1/1	-	-
	ESC-4	-	19046590	1062x670	Height-adjustable shelf for 4 GN 1/1	-	-
	ESC-5	-	19046591	1447x670	Height-adjustable shelf for 5 GN 1/1	-	-
	ESC-6	-	19046592	1797x670	Height-adjustable shelf for 6 GN 1/1	-	-
	FS-VIT	-	19046602	-	Stainless steel frame support for glass ceramic self-service elements	-	-
	SP-70	-	19043113	680x250x170	Stainless steel plate rack shelf for island-type elements	-	-
	PAL-DROPIN	-	19046641	-	Tool to lift technical elements	-	-



Z-3GN









IPCTI



DBFLI

MODEL	CODE	DESCRIPTION	€
PLINTHS			
Z-SS-77-ISL	19046603	Plinth for self-service base SS-77	-
Z-SS-147-ISL	19046604	Plinth for self-service base SS-147	-
Z-SM-450	19046605	Plinth for neutral element SM-450	-
Z-SA-I-90	19046630	Plinth for corner element SA-I-90	-
Z-SA-I-45	19046631	Plinth for corner element SA-I-45	-
Z-SA-E-90	19046632	Plinth for corner element SA-E-90	-
Z-SA-E-45	19046633	Plinth for corner element SA-E-45	-
Z-2GN	19046611	Plinth for attended self-service element 2GN	-
Z-3GN	19046614	Plinth for attended self-service element 3GN	-
Z-4GN	19046617	Plinth for attended self-service element 4GN	-
Z-5GN	19046620	Plinth for attended self-service element 5GN	-
Z-6GN	19046623	Plinth for attended self-service element 6GN	-
Z-3GN-ISL	19046626	Plinth for self-service island 3GN	-
Z-4GN-ISL	19046627	Plinth for self-service island 4GN	-
Z-5GN-ISL	19046628	Plinth for self-service island 5GN	-
Z-6GN-ISL	19046629	Plinth for self-service island 6GN	-
Z-FL-850	19081706	Plinth end of line 850 mm element	-

MODEL	HZ	CODE	DIMENSIONS (mm)	DESCRIPTION	POWER (W)	€
DIGITAL THERMOMETER KIT						
	IPCI	50/60	19053060	132x84x70	Switch	1 -
	IPCTD	50/60	19053058	132x84x70	Thermometer cold elements	1 -
	IPCTI	50/60	19053061	132x84x70	Thermometer and switch cold elements	1 -
	IPCTD-C	50/60	19052024	132x84x70	Thermometer hot elements	1 -
	IPCTI-C	50/60	19055869	132x84x70	Thermometer and switch hot elements	1 -

MODEL	CODE	DESCRIPTION	APPLIES TO	€
END OF LINE DECORATION				
	DBFLI	19080942	Basic color decoration end of line left	-
	DBFLD	19080943	Basic color decoration end of line right	-

Configuration options

Facade decoration

- ODF0020_BF Facade decorated with laminated panels in color. To be chosen from 16 basic colors:

- BF3091 Crystal White
- BF7927 Folkestone
- BF7912 Storm
- BF2253 Diamond Black
- BF7940 Spectrum Yellow
- BF3210 Levante
- BF1238 Carnaval
- BF6907 Amarena
- BF4177 Lemon
- BF8755 Lime
- BF6901 Vibrant Green
- BF0187 Kashmir
- BF5347 Maui
- BF1326 Capri
- BF5127 Monaco
- BF0157 Tahiti



Castors

- OBF0011+OBF0012 Sound-proof stainless steel swivel castors.
- OBF0011 Swivel castor with brake.
- OBF0012 Swivel castor without brake.



Automatic filling function for bain marie

- OBM0010 Automatic filling function and level detector for bain marie elements.



Refrigerated elements

- Climate class III
 - OGF0040 230V 1N 50Hz elements.
 - OGF0041 230V 1N 60Hz elements.
- Climate class IV
 - OGF0000 230V 1N 50Hz elements.
 - OGF0010 230V 1N 60Hz elements.
- Climate class V
 - OGF0030 230V 1N 50Hz elements.
 - OGF0031 230V 1N 60Hz elements.
- Remote cold group
 - OGF0099 Remote cold group elements.





ENOLUX

Wine and Meat at the Center of the Dining Hall.



Find out more!



Access the website



Il price list

Wine cellars and dry ager cabinets

Wine cellars Enolux

- Advance	329
- Concept	331

Meat dry ager cabinets Meat Ager

- Advance	
· Meat, salami and cheese (MA)	332
· Meat (MD)	333
- Concept	335

Wine cellars Enolux | Advance







General characteristics

- Wine cellar specially designed to preserve, display and distribute wine.
- Fully manufactured in stainless steel for intensive professional use.
- Models available in central or wall configuration.
- Side and central walls with double-layered glass and air chamber between them.
- Glasses and door frames heated to avoid condensations.
- Models available in one (1) and two (2) doors.
- Models available in two (2) heights: 2,600 and 2,300 mm.
- Swing doors that optimize space usage and make work easier.

- Ventilated refrigeration system to obtain a homogeneous temperature inside the cellar.
- Optional humidity control to create an optimal wine conservation environment.
- Independent digital thermostat for each environment.
- Tray to collect defrost water and automatic evaporation. No drain required.





- White LED lighting in all perimeters, adjustable by remote control. Other LED color options available on demand.
- Models available in two (2) colors: Black (BLA) and Gray (GRE). Other color options available on demand.
- For easy delivery, wine cellars are shipped in two sections: body and removable top section

- containing complete refrigeration unit.
- The entire range includes decorative plinth as a standard element.
- Refrigerant gas: R452a Hydrofluorocarbon olefin (HFO/HFC).
- Operating temperature (in climate class V conditions, ambient temperature up to +40°C and relative humidity 40%): +4°C to +18°C.

	MODEL	HZ	CODE	DIMENSIONS (mm)	FINISHING	DOORS	TEMPERATURES	POWER (W)	€
CENTRAL WINE CELLARS									
	WC-2301-T1-C-L-W-GRE TR	50	19067857	862 x 632 x 2300	Grey	1	1	1490	-
	WC-2302-T2-C-LR-W-GRE TR	50	19067858	1697 x 632 x 2300	Grey	2	2	2980	-
	WC-2301-T1-C-L-W-BLA TR	50	19067859	862 x 632 x 2300	Black	1	1	1490	-
	WC-2302-T2-C-LR-W-BLA TR	50	19067860	1697 x 632 x 2300	Black	2	2	2980	-
	WC-2601-T1-C-L-W-GRE TR	50	19067861	862 x 632 x 2600	Grey	1	1	1605	-
	WC-2602-T2-C-LR-W-GRE TR	50	19067862	1697 x 632 x 2600	Grey	2	2	3190	-
	WC-2601-T1-C-L-W-BLA TR	50	19067863	862 x 632 x 2600	Black	1	1	1605	-
	WC-2602-T2-C-LR-W-BLA TR	50	19067864	1697 x 632 x 2600	Black	2	2	3190	-
	WC-2302-T1-C-LR-W-GRE TR	50	19067874	1697 x 632 x 2300	Grey	2	1	2580	-
	WC-2302-T1-C-LR-W-BLA TR	50	19067875	1697 x 632 x 2300	Black	2	1	2580	-
	WC-2602-T1-C-LR-W-GRE TR	50	19067876	1697 x 632 x 2600	Grey	2	1	2700	-
	WC-2602-T1-C-LR-W-BLA TR	50	19067877	1697 x 632 x 2600	Black	2	1	2700	-
WALL-MOUNTED WINE CELLARS									
	WC-2301-T1-W-L-W-GRE TR	50	19067865	862 x 632 x 2300	Grey	1	1	1490	-
	WC-2302-T2-W-LR-W-GRE TR	50	19067866	1697 x 632 x 2300	Grey	2	2	2980	-
	WC-2301-T1-W-L-W-BLA TR	50	19067867	862 x 632 x 2300	Black	1	1	1490	-
	WC-2302-T2-W-LR-W-BLA TR	50	19067868	1697 x 632 x 2300	Black	2	2	2980	-
	WC-2601-T1-W-L-W-GRE TR	50	19067869	862 x 632 x 2600	Grey	1	1	1605	-
	WC-2602-T2-W-LR-W-GRE TR	50	19067870	1697 x 632 x 2600	Grey	2	2	3190	-
	WC-2601-T1-W-L-W-BLA TR	50	19067871	862 x 632 x 2600	Black	1	1	1605	-
	WC-2602-T2-W-LR-W-BLA TR	50	19067872	1697 x 632 x 2600	Black	2	2	3190	-
	WC-2302-T1-W-LR-W-GRE TR	50	19067878	1697 x 632 x 2300	Grey	2	1	2580	-
	WC-2302-T1-W-LR-W-BLA TR	50	19067879	1697 x 632 x 2300	Black	2	1	2580	-
	WC-2602-T1-W-LR-W-GRE TR	50	19067880	1697 x 632 x 2600	Grey	2	1	2700	-
	WC-2602-T1-W-LR-W-BLA TR	50	19067873	1697 x 632 x 2600	Black	2	1	2700	-

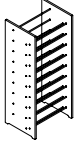
Cold group options: 60Hz and remote cold group.

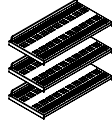
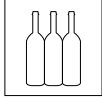
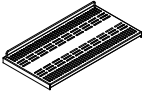
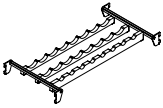
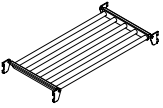
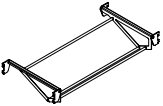
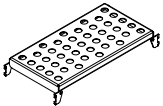
Accessories

METHACRYLATE SIDES WITH ROD SHELVING	BOTTLES X SHELF	SHELVES X BODY CELLAR	SHELVES X BODY CELLAR	€
	 BORDEAUX			
19067947 DIM-20-23 (h 2300 mm)	7 bottles	9 shelves	63 bottles	-
19067948 DIM-20-26 (h 2600 mm)	7 bottles	11 shelves	77 bottles	-
STAINLESS STEEL OR METHACRYLATE SHELVES AND SALAMI HANGING HOOK	BOTTLES X SHELF	SHELVES X BODY CELLAR (H 2300 / 2600 MM)	BOTTLES X BODY CELLAR (H 2300 / 2600 MM)	€
 19067949 DIS-90	42 bottles	3 / 4 shelves	168 / 210 bottles (using cellar base)	-
 19067950 DIS-0-90	8 bottles	9 / 11 shelves	72 / 108 bottles	-
 19067951 DIS-0-180	8 bottles	9 / 11 shelves	72 / 108 bottles	-
 19067952 DIS-20	9 bottles	9 / 11 shelves	81 / 99 bottles	-
 19067953 DIM-90	20 kg (transparent methacrylate shelf to place salami and cheese)	5 / 6 shelves	100 Kg / 120 Kg	-
 19067988 G-10	10 kg (salami)			-

Wine display cabinets Enolux | **Concept**



General characteristics

- Our range of wine cooler cabinets provides modern and elegant solutions for wine storage and to keep bottles ready for consumption. Thanks to their innovative design, they are a decorative element to add to the elegant look of your business.
- Pre-lacquered steel outside. Sanitary thermoformed plastic inside with embedded inner tray slides (polystyrene).
- 45 mm, 40 kg/m³ injected polyurethane insulation.
- Forced draught cooling system with low vibration compressor.
- Inner evaporator with forced draught. Outer low maintenance condenser with forced draught.

- Digital display for electronic and digital control of temperature and defrosting.
- Double pane door with tinted glass and UV filter for sunlight protection.
- Black plastic covered steel grid removable

shelves for easy cleaning.

- Equipment: 3 flat shelves and 1 tipped shelf for main bottles or the conservation of opened bottles (models WR-300/600) one flat unit for model WR-180.

- LED vertical lighting system.
- Working temperature: +5 °C, +16 °C (room temperature: 32 °C).



WR-180



WR-300



WR-600



KIT-WR-180

	MODEL	COOLANT	HZ.	CODE	DIMENSIONS (mm)	N° OF DOORS	GROSS CAPACITY (L)	BOTTLES CAPACITY (75 CL)	ELECTRIC POWER (W)	€
	WR-180	R-600a	50	19034852	505x570x950	1	130	25	225	-
			60	19075367					-	
	WR-300	R-600a	50	19034732	620x655x1.850	1	400	72	257	-
			60	19075368					-	
	WR-600	R-600a	50	19034762	1.240x655x1.850	2	800	144	513	-
			60	19075369					-	

Accessories



KIT	CODE	QUANTITY OF KITS TO ORDER BY APPLIANCE			€
		WR-180	WR-300	WR-600	
KIT SHELVES OF WOOD FOR WR					
KIT WR-180	19045931	x 1	-	-	-
KIT WR-300	19045612	-	x 1	x 2	-

Dry-aging meat, salami and cheese cabinet (MA) Meat Ager | **Advance**



General characteristics

- Dry aging cabinet specially designed to age, display and distribute meat, salami and cheese.
- Fully manufactured in stainless steel for intensive professional use.
- Models available in central or wall configuration.
- Side and central walls with double-layered glass and air chamber between them.
- Glasses and door frames heated to avoid condensations.
- Models available in one (1) and two (2) doors.
- Models available in two (2) heights: 2,600 and 2,300 mm.
- Swing doors that optimize space usage and make work easier.
- One (1) digital thermostat for temperature and humidity control.
- Refrigeration system adjustable between 0 and +4°C with increments of 0.1°C.
- Ventilated refrigeration system to obtain a homogeneous temperature inside the cellar.
- Ultraviolet light on the evaporator aspiration for air sterilization.
- Water supply with ½" inlet. ½" Drain.
- Water treatment through a reverse osmosis system.
- Ultra sound nebulizer allowing humidity adjustment between 60 and 90%.
- High intensity LED lighting with color temperature 2700°K
- Models available in two (2) colors: Black (BLA) and Gray (GRE). Other color options available on demand.
- For easy delivery, dry-aging cabinets are shipped in two sections: body and removable top section containing complete refrigeration unit.
- The entire range includes decorative plinth as a standard element.
- Refrigerant gas: R452a Hydrofluorocarbon olefin (HFO/HFC).
- Operating conditions: climate class V (ambient temperature up to +40°C and relative humidity 40%).

	MODEL	HZ	CODE	DIMENSIONS (mm)	FINISHING	DOORS	POWER (W)	€
CENTRAL DRY-AGING CABINET								
	MA-2302-C-LR-W-GRE TR	50	19073417	1697 x 632 x 2300	Grey	2	1965	-
	MA-2302-C-LR-W-BLA TR	50	19073418	1697 x 632 x 2300	Black	2	1965	-
	MA-2602-C-LR-W-GRE TR	50	19073431	1697 x 632 x 2600	Grey	2	2070	-
	MA-2602-C-LR-W-BLA TR	50	19073432	1697 x 632 x 2600	Black	2	2070	-
WALL MOUNTED DRY-AGING CABINET								
	MA-2301-W-L-W-GRE TR	50	19073411	862 x 632 x 2300	Grey	1	1090	-
	MA-2301-W-L-W-BLA TR	50.	19073412	862 x 632 x 2300	Black	1	1090	-
	MA-2601-W-L-W-GRE TR	50	19073413	862 x 632 x 2600	Grey	1	1170	-
	MA-2601-W-L-W-BLA TR	50	19073414	862 x 632 x 2600	Black	1	1170	-
	MA-2302-W-LR-W-GRE TR	50.	19073415	1697 x 632 x 2300	Grey	2	1965	-
	MA-2302-W-LR-W-BLA TR	50.	19073416	1697 x 632 x 2300	Black	2	1965	-
	MA-2602-W-LR-W-GRE TR	50.	19073419	1697 x 632 x 2600	Grey	2	2070	-
	MA-2602-W-LR-W-BLA TR	50.	19073430	1697 x 632 x 2600	Black	2	2070	-

Cold group options: 60Hz and remote cold group.

Dry-aging meat cabinet (MD) Meat Ager | **Advance**









General characteristics

- Dry aging cabinet specially designed to age, display and distribute meat.
- Fully manufactured in stainless steel for intensive professional use.
- Models available in central or wall configuration.
- Side and central walls with double-layered glass and air chamber between them.
- Glasses and door frames heated to avoid condensations.
- Models available in one (1) and two (2) doors.
- Models available in two (2) heights: 2,600 and 2,300 mm.
- Swing doors that optimize space usage and make work easier.
- One (1) digital thermostat for temperature and humidity control.
- Refrigeration system adjustable between 0 and +20°C with increments of 0.1°C.
- Ventilated refrigeration system to obtain a homogeneous temperature inside the cellar.
- Ultraviolet light on the evaporator aspiration for air sterilization.
- Tray to collect defrost water and automatic evaporation. No drain required.
- Thermostat to adjust humidity between 60 and 90%.
- High intensity LED lighting with color temperature 2700°K.
- Models available in two (2) colors: Black (BLA) and Gray (GRE). Other color options available on demand.
- For easy delivery, dry-aging cabinets are shipped in two sections: body and removable top section containing complete refrigeration unit.
- The entire range includes decorative plinth as a standard element.
- Refrigerant gas: R452a Hydrofluorocarbon olefin (HFO/HFC).

	MODEL	HZ	CODE	DIMENSIONS (mm)	FINISHING	DOORS	POWER (W)	CLIMATE CLASS	€
CENTRAL DRY-AGING CABINET									
	MD-2301-C-L-W-GRE TR	50	19073436	862 x 632 x 2300	Grey	1	1865	V	-
	MD-2301-C-L-W-BLA TR	50	19073437	862 x 632 x 2300	Black	1	1865	V	-
	MD-2601-C-L-W-GRE	50	19071156	862 x 632 x 2600	Grey	1	1925	IV	-
	MD-2601-C-L-W-BLA	50	19071157	862 x 632 x 2600	Black	1	1925	IV	-
	MD-2302-C-LR-W-GRE TR	50	19073441	1697 x 632 x 2300	Grey	2	3155	V	-
	MD-2302-C-LR-W-BLA TR	50	19073442	1697 x 632 x 2300	Black	2	3155	V	-
	MD-2602-C-LR-W-GRE	50	19067903	1697 x 632 x 2600	Grey	2	3275	IV	-
	MD-2602-C-LR-W-BLA	50	19067904	1697 x 632 x 2600	Black	2	3275	IV	-
WALL MOUNTED DRY-AGING CABINET									
	MD-2301-W-L-W-GRE TR	50	19073434	862 x 632 x 2300	Grey	1	1865	V	-
	MD-2301-W-L-W-BLA TR	50	19073435	862 x 632 x 2300	Black	1	1865	V	-
	MD-2601-W-L-W-GRE	50	19071154	862 x 632 x 2600	Grey	1	1925	IV	-
	MD-2601-W-L-W-BLA	50	19071155	862 x 632 x 2600	Black	1	1925	IV	-
	MD-2302-W-LR-W-GRE TR	50	19073438	1697 x 632 x 2300	Grey	2	3155	V	-
	MD-2302-W-LR-W-BLA TR	50	19073439	1697 x 632 x 2300	Black	2	3155	V	-
	MD-2602-W-LR-W-GRE	50	19067901	1697 x 632 x 2600	Grey	2	3275	IV	-
	MD-2602-W-LR-W-BLA	50	19067902	1697 x 632 x 2600	Black	2	3275	IV	-

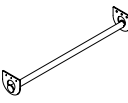
Cold group options: 60Hz and remote cold group.

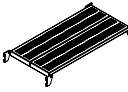
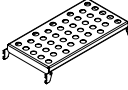
Accessories

	MODEL	CODE	DESCRIPTION	€
	HSM-4	19067989	4 Himalayan pink salt blocks*. Tray included. Only applies to MD models.	-
	HSM-6	19068295	6 Himalayan pink salt blocks*. Tray included. Only applies to MD models.	-
	BS1	19067991	Top bar to hang large pieces of meat. Maximum 200 kg. 2 BS1 per door.	-
	DIS-0-180	19067951	Stainless steel shelf to hang salamis, sausages and smaller pieces of meat.	-
	DIS-MB	19067990	Perforated stainless steel shelf to place pieces of meat.	-
	DIS-M	19067994	Perforated stainless steel shelf. Only applies to 1-body MA models.	-
	DIM-90	19067953	Transparent methacrylate shelf to place salami and cheese.	-
	G-10	19067988	Hook to hang salami and smaller pieces of meat. Maximum 10 kg.	-
	G-200	19067993	Hook to hang large pieces of meat. Maximum 200 kg.	-

* Himalayan pink salt stabilizes moisture in the dry-aging cabinet and enhances meat flavor.

Meat dry ager cabinet Meat Ager | **Concept**



General characteristics

- Fagor's Meat Ager cabinet stands out from the competition thanks to its innovative design and its efficient performance. Its humidity and temperature control system, along with its UVC sterilisation, provide it with maximum safety, creating perfect air circulation within the cabinet.
- Interior LED vertical light maximising the visibility of the product, with no ultraviolet radiation.
- Steel-plated interior and exterior, providing a sturdy build quality.
- UV air sterilisation.
- Activated carbon filter.
- Injected polyurethane insulation, CFC-free and with a density of 40kg/m³.
- Double-glazed hinged door with automatic closing system and fixed opening.
- Two adjustable front feet and four rear rollers, allowing it to be transported easily.
- Even distribution of cold inside the cabinet thanks to its excellent ventilated refrigeration system and its anti-corrosion evaporator.
- Temperature control through a digital thermostat, with an automatic defrosting system.
- Automatic evaporation of defrost water.
- Electronic humidistat.
- Low-maintenance condenser.
- Cabinet exterior available in stainless steel or black finish.
- Supplied with four shelves, each with a 40 kg load weight. Standard shelves made from metal rods covered in anti-bacterial plastic.
- Locked fitted as standard.
- Individually palletised.



FMA-1650



FMA-1650 B



FMA-900



FMA-900 B

	MODEL	REFRIGERANT	HZ	CODE	INTERNAL DIMENSIONS (mm)	EXTERNAL DIMENSIONS (mm)	NET INTERNAL VOL. (L)	TEMPERATURE RANGE (°C)	HUMIDITY LEVEL (%)	ELECTRIC POWER (W)	€
Palletised	FMA-1650	R-600a	50	19073883	595 x 615 x 1424	700 x 750 x 1665	496	0 / +20	60 al 90	1,7	-
			60	19079369						-	
Palletised	FMA-1650 B	R-600a	50	19073884	595 x 615 x 1424	700 x 750 x 1665	496	0 / +20	60 al 90	1,7	-
			60	19079440						-	
Palletised	FMA-1650 S	R-600a	50	19081264	595 x 615 x 1424	700 x 750 x 2050	496	0 / +20	60 al 90	1,7	-
			60	19081265						-	
Palletised	FMA-900	R-600a	50	19073881	490 x 474 x 686	600 x 620 x 925	140	0 / +20	60 al 90	1	-
			60	19073882						-	

Accessories



CODE	MODEL	FOR MODELS	€
12236057	HIMALAYA SALT BLOCK 200X200X30MM		*
12241490	HIMALAYA SALT SUPPORT	FMA-1650	*
12241489	HIMALAYA SALT SUPPORT	FMA-900	*
19074041	BAR+HOOK KIT FMA-1650	FMA-1650	-
19074042	BAR+HOOK KIT FMA-900	FMA-900	-
19081970	STAND FMA-900 B	FMA-900 B	-
19074043	STAND FMA-1650 B	FMA-1650	-
19081971	GRIDS KIT EP FMA-1650	FMA-1650	-
19081972	GRIDS KIT EP FMA-900	FMA-900	-

* Check prices at the list of accessories and spare parts.



Performance and productivity at maximum power.



Find out more!



Access the website



Il price list

Trolleys and counters for distribution

Hot trolleys with humidity control	339
Hot trolleys for distribution	340
Refrigerated trolleys for distribution ...	341
Hot counters	342

Hot trolleys with humidity control



General characteristics

- All parts of the trolley have been carefully analysed and tested to offer maximum temperature performance in the interior, bearing in mind the following most important requirements: ease of use, minimum maintenance and facilitation of cleaning tasks.
- Modern and intuitive electronic control panels.
- Double walled sides and door, insulated with high density polyurethane, giving great robustness and firmness.
- Recessed monoblock guides with wide radius, guaranteeing maximum hygiene.
- Efficient heat production system composed of heating element and fan.
- Recessed water reservoir with rounded corners. The heat is produced by a high-performance silicon heating element.
- 4-level humidity regulation system to adapt to the different products kept inside. The humidity system can also be fully switched off, reducing energy consumption.
- The 270° opening door offers users maximum freedom of movements and safety during daily use, increasing comfort and well-being during work operations.
- The inner door panel is completely smooth and free from any elements that might prevent thorough cleaning.
- No heat loss. Door seal fixed to the frame of the structure. Can be replaced easily without the need for tools.
- The whole perimeter is protected by a bumper, manufactured in resistant, non-marking material.
- Pivoting wheels, 2 with brakes.
- Manufactured completely in AISI-304 stainless steel.
- Heat system designed to reach the operational temperature in a very short space of time.
- Electronic membrane keypad and digital display.
- Ergonomic latch with lock.
- Modern, elegant and very robust design.
- Operational temperature 30 °C to 90 °C.
- Storage of GN 2/1 y GN 1/1 trays with depth of up to 65 mm.
- Shelves and Gastronorm pans are not included.

	MODEL	VOLTAGE AND FREQUENCY	CODE	DIMENSIONS (mm)	DOORS	LEVELS GN-2/1 (SEPARATION 70 mm)	POWER (W)	€
	CCHF-10	230 V-1+N - 50/60 Hz	19044546	790x935x1.215	1	10	2.000	-
	CCHF-20	230 V-1+N - 50/60 Hz	19044549	790x935x1.855	1	20	2.000	-
	CCHF-40	230 V-1+N - 50/60 Hz	19044551	1.525x935x1.885	2	40	3.500	-

Hot trolleys for distribution





General characteristics

- Especially designed for maintaining and serving previously prepared hot food.
Food can be hold inside the trolley directly on plates by using of rod shelves or in Gastronorm pans.
- 10, 20 or 40 GN2/1 rack rails (according to the model) with 60 mm separation between rack rails.
- Doubled wall with an injected CFC-free, ecological polyurethane 40 kg/m³ density isolation. With its highly-insulated walls, heat losses are reduced thus obtaining energy savings.
- Heating system by using two (2) forced-air electric resistors in each cabinet body

- to ensure that heat is distributed trough all the unit. The special design of the chamber and rack rails enables the creation of a uniform, even airflow distribution, ensuring that food is always maintained at its right temperature.
- Waveless evaporation tray system to control humidity in the chamber and prevent food from drying out.
- Thermostat and external thermometer to monitor, control and regulate the temperature at desired setpoint: from 0 °C to 90 °C.
- Horizontal handle system for fast opening and closing of door.

- Automatic locking mechanism in hinges: when door is in a position of less than a 90° angle it gets fully closed, thus avoiding loss of temperature and achieving energy savings.
- Four (4) sound-proof castors of 160 mm diameter, two of them with brakes for an easy handling and safer use. Non-marking, special rubber bumpers to protect against direct impacts along the whole trolley base.
- Key locked door.
- Made of stainless steel.
- Shelves and Gastronorm pans are not included.



	MODEL	VOLTAGE AND FREQUENCY	CODE	DIMENSIONS (mm)	DOORS	LEVELS GN-2/1 (SEPARATION 60 mm)	POWER (W)	€
	CCF-10	230 V-1+N - 50/60 Hz	19036263	799x876x1.190	1	10	2.000	-
	CCF-20	230 V-1+N - 50/60 Hz	19036264	799x876x1.640	1	20	2.000	-
	CCF-40	230 V-1+N - 50/60 Hz	19036265	1.489x876x1.640	2	40	3.500	-

Refrigerated trolleys for distribution



General characteristics

- Especially designed for maintaining and serving previously prepared cold food. Ideal to replace cold chambers or refrigeration units.
- Refrigeration unit with fan built inside the chamber. A constant flow of chilled air is generated by the evaporation fans, leading to a fastest temperature drop, as well as a better, more uniform cool air distribution.
- Digital reading electronic to monitor and control chamber temperature and defrosting cycle.
- Operating temperature ranges from +2 °C to +8 °C with a 32 °C room temperature.
- Doubled wall with an injected CFC-free, ecological polyurethane.
- 40 kg/m³ density isolation. With its highly-insulated walls, heat transfers are reduced thus obtaining energy savings.
- Automatic locking mechanism in hinges: when door is in a position of less than a 90° angle it gets fully closed, thus avoiding rising of temperature.
- Four (4) sound-proof castors of 125 mm diameter, two of them with brakes for an easy handling and safer use. Non-marking, special rubber bumpers to protect against direct impacts in all four (4) corners.
- Key locked door.
- Made of stainless steel.
- GN 2/1 shelves supplied as standard depending on model.
- Operating voltage and frequency: 230 V
- 1+N 50 Hz.

	MODEL	CODE	DIMENSIONS (mm)	DOORS	LEVELS GN-2/1 (SEPARATION 60mm)	INCLUDED (GN-2/1)		POWER (W)	€
						PAIRS OF GUIDES	SHELVES		
	CFF-20	19036266	799x876x1.878	1	17	5	5	350	-
	CFF-40	19036280	1.489x876x1.878	2	40	10	10	575	-

Hot counters



General characteristics

- Designed to keep food hot in kitchen area, before its distribution or service.
- Internally and externally made of stainless steel.
- Forced-air heating system.
- Double-wall doors, ecological CFC-free, polyurethane insulated with a density of 40 kg/m³.
- Reinforced structure and insulation, body with rounded edges.
- Intermediate undershelf included.
- Thermostat control to maintain temperature at desired setpoint.
- Analog thermometer.
- Auto safety operating pilot.
- Stainless steel legs with adjustable working height.

MODEL	CODE	DIMENSIONS (mm)	TYPE (*)	POWER (KW)	€
AC-120	19006746	1.200x700x850	Wall	2,20	-
AC-180	19007770	1.800x700x850	Wall	3,68	-
ACC-120	19006745	1.200x700x850	Pass-through	2,20	-
ACC-180	19007769	1.800x700x850	Pass-through	3,68	-

(*) TYPE: **WALL MODELS:** 2 sliding doors. / **PASS-THROUGH MODELS:** 2 sliding doors at each side.









Dishwashing



	GLASSWASHER			FRONT LOADING			HOOD-TYPE	
	CONCEPT+	CONCEPT	ADVANCE	CONCEPT+	CONCEPT	ADVANCE	CONCEPT+	CONCEPT
Basket Size	400x400	400x400	350x350	500x500	500x500	500x500	500x500	500x500

CONTROL PANEL

OTHERS

				AD-505			AD-125	
	With rinsing pump	COP-404			COP-504			COP-144
	Without rinsing pump		CO-402			CO-502		CO-142
	Multi-power					CO-501		CO-110
	Single phase		CO-400	CO-350		CO-500		

One body, three ranges.

E-VO Generation is a dream come true, something more than one step further: it is a different and innovative generation... Revolutionary.

Because E-VO is built on a unique basic idea: create a single body structure that offers common benefits for its three different ranges: E-VO ADVANCE, E-VO CONCEPT PLUS and E-VO CONCEPT.

All 3 ranges, advance, concept plus and concept, boast common structural characteristics:



Glasswasher

- Front-loading glass washers - EVO Generation.
- Constructed in stainless steel.
- Door with double wall.
- Double rotating wash and rinse system, top and bottom, in stainless steel.
- Rounded tank to facilitate washing and drainage.
- Stainless steel armoured heating elements in the wash tank and rinse boiler.
- Thermostatic control of temperatures (wash, 60°C, and rinse, 85°C).
- Safety thermostat
- Rinse aid doser incorporated.
- Fitted with non-return valve.
- 260 W wash pump
- Water consumption per 2.2 litre cycle.
- Magnetic safety stop switch in door opening.
- IPX4 anti-humidity protection.

CONCEPT PLUS
CONCEPT



Front loading

- Front-loading dishwashers - EVO Generation.
- Constructed in stainless steel.
- Whole body with double wall.
- Counterbalanced door with stainless steel hinges and double spring.
- Furniture which allows the machine to be positioned under 850 mm high work surfaces.
- Double rotating wash and rinse system, top and bottom, in stainless steel.
- Rounded tank to facilitate washing and drainage.
- Stainless steel armoured heating elements in the wash tank and rinse boiler.
- Useful internal height of 380 mm. Accepts GN 1/1 trays.
- Thermostatic control of temperatures (wash, 60°C, and rinse, 85°C).
- 600 W wash pump with SOFT-START.
- Stainless steel armoured heating elements in the wash tank and rinse boiler.
- Water consumption per 2.4 litre cycle.
- Rinse aid doser incorporated.
- Magnetic safety stop switch in door opening.
- Safety thermostat
- Model for 500 x 500 mm baskets.

ADVANCE
CONCEPT PLUS
CONCEPT



Hood-type

- Hood-Type dishwashers - EVO Generation
- Constructed in stainless steel.
- Counterbalanced hood with handle and spring system.
- Double rotating wash and rinse system, top and bottom, in stainless steel.
- 440 mm hood opening (Accepts GN 1/1 trays).
- 750 W wash pump providing high water flow.
- Rounded tank to facilitate washing and drainage.
- Stainless steel armoured heating elements in the wash tank and rinse boiler.
- Multi-voltage: Allows the machine to be connected to a single-phase or three-phase voltage network. (230 1N~/230 3~/400V 3N~).
- AISI-304 stainless steel filter trays in the wash tank.
- Thermostatic control of temperatures (wash, 60°C, and rinse, 85°C).
- Thermal stop system which guarantees a rinse temperature of 85°C.
- Safety stop switch in hood opening.
- Safety thermostat.
- Water consumption per 2.4 litre cycle.
- Model for 500 x 500 mm baskets.

ADVANCE
CONCEPT PLUS
CONCEPT



The small and versatile solution for sparkling results.



Find out more!



Access the website



Sales brochure

Glasswasher

Concept +	349
Concept.....	350
Accessories	354

Water connection:
It is advisable to introduce sanitary water in the dishwashers, with a temperature of 50 - 60 °C.

Water pressure:
Minimum: 2 bar = 2 kg/cm²
Maximum: 4 bar = 4 kg/cm²

Water softener:
All glass / dishwashers should be connected to a treated water supply when the local supply is over 10 HF / 6 HD.

Any issues derived from a bad installation that don't meet with the indicated conditions will not be considered as a warranty.

Glasswashers | Concept +



General characteristics

- Model with electronic control and display of temperature, functions and errors.
- Control with help system for technical service.
- Thermostop system with rinse pump that guarantees a perfect hygienic result with a complete rinse at 80–85 °C (EFFIRINSE) in accordance with the safety and hygiene specifications of standard DIN10512..
- Air Break check valve system type AA according to EN 1717/WRAS.
- Model for 400 x 400 mm baskets.
- 90s - 120s – 180s wash cycles and maximum production of 40 baskets/hour.
- Useful internal height of 270 mm.
- Tank with volume of 15 litres, with 2 kW heating element.
- Boiler with volume of 4 litres, with 2.8 kW heating element.

	MODEL	"CODE 50 HZ."	"CODE 60 HZ."	€
CHARACTERISTICS				
Basic model	COP-404	19073733	19081232	-
Rinse pump	A	A		
Voltage		230 V / 1N		
Power	(kW)	3,06		
Dimensions	(mm)	470x520x720		
VERSIONS				
Built-in drain pump	B	COP-404 B	19075262	19081233
Built-in detergent doser	DD	COP-404 DD	19075263	19081234
Drainage pump and detergent doser	B - DD	COP-404 B DD	19075264	19081235

* Consult other possible factory versions.

ACCESSORIES	
Stands	See page. 354
Conversion kits	See page. 354
Water softeners	See page. 410
Osmosis	See page. 410
Baskets	See page. 411

Accessories supplied: Two 400x 400 mm base baskets, 1 supplement for plates and a small basket for cutlery.

Glasswashers | Concept



CO-402

BASKET 400 x 400 mm

General characteristics

- Model with electronic control and display of temperature, functions and errors.
- Control with help system for technical service.
- Model for 400 x 400 mm baskets. 90s - 120s – 180s wash cycles and maximum production of 40 baskets/hour.
- Useful internal height of 270 mm.
- Tank with volume of 15 litres, with 2 kW heating element.
- Boiler with volume of 4 litres, with 2.8 kW heating element.
- Thermal stop system which guarantees a rinse temperature of 85°C. Standard factory setting disabled.

		MODEL	*CÓDIGO50 HZ.*	*CÓDIGO60 HZ.*	€
CHARACTERISTICS					
 Basic model		CO-402 COLD	19073542	19081225	-
Manual push button for final cold rinse	COLD	COLD			
Voltage		230 V / 1N			
Power	(kW)	3,06			
Dimensions	(mm)	470x520x720			
VERSIONS					
Drainage pump	B	CO-402 COLD B	19075256	19081226	-
Peristaltic detergent doser	DD	CO-402 COLD DD	19075257	19081227	-
Bomba de desagüe y dosificador de detergente peristáltico	B - DD	CO-402 COLD B DD	19075254	19081228	-
Descaling system and tank with regeneration program	SOFT - DD	CO-402 COLD SOFT DD	19073547	19081229	-
UK type plug	B DD CI	CO-402 COLD B DD CI	19075260	19081231	-

* Consult other possible factory versions.

ACCESORIES	
Stands	See page. 354
Conversion kits	See page. 354
Water softeners	See page. 410
Baskets	See page. 411

Accessories supplied: Two 400x 400 mm base baskets, 1 supplement for plates and a small basket for cutlery.

Glasswashers | Concept







CO-400

BASKET 400 x 400 mm

General characteristics

- Model with highly resistant control buttons.
- Model for 400 x 400 mm baskets.
- 120s fixed wash cycle and maximum production of 30 baskets/hour.
- Useful internal height of 270 mm.
- Tank with volume of 15 litres, with 2 kW heating element.
- Boiler with volume of 4 litres, with 2.8 kW heating element.

		MODEL	"CÓDIGO50 HZ."	"CÓDIGO60 HZ."	€	
CHARACTERISTICS						
	Basic model	CO-400	19073541	19081255	-	
	Voltage	230 V / 1N				
	Power (kW)	3,06				
	Dimensions (mm)	470x520x720				
VERSIONS						
	Drainage pump	B	CO-400 B	19081172	19081209	-
	Peristaltic detergent doser	DD	CO-400 DD	19081173	19081220	-
	UK type plug	CI	CO-400 CI	19075250	19081236	-
	Cold model	CO-400 COLD	19073546	19081221	-	
	Manual push button for final cold rinse	COLD	COLD			
VERSIONS						
	Drainage pump	B	CO-400 COLD B	19075251	19081222	-
	Peristaltic detergent doser	DD	CO-400 COLD DD	19075252	19081223	-
	Drainage pump and peristaltic detergent doser	B - DD	CO-400 COLD B DD	19075253	19081224	-

* Consult other possible factory versions.

ACCESORIES	
Stands	See page. 354
Conversion kits	See page. 354
Water softeners	See page. 410
Baskets	See page. 411

Accessories supplied: Two 400x 400 mm base baskets, 1 supplement for plates and a small basket for cutlery.

Glasswashers | Concept



General characteristics

- Model with highly resistant control buttons.
- Model for 350 x 350 mm baskets.
- 120s fixed wash cycle and maximum production of 30 baskets/hour.
- Useful internal height of 220 mm.
- Tank with volume of 11 litres, with 2 kW heating element.
- Boiler with volume of 4 litres, with 2.4 kW heating element.

		MODEL	"CODE 50 HZ."	CODE 60 HZ."	€	
CHARACTERISTICS						
	Basic model	CO-350	19073540	19081136	-	
	Voltage	230 V / 1N				
	Power (kW)	2,66				
	Dimensions (mm)	430x480x660				
VERSIONS						
	Drainage pump	B	CO-350 B	19075244	19081183	-
	Peristaltic detergent doser	DD	CO-350 DD	19075245	19081184	-
	Drainage pump and peristaltic detergent doser	B - DD	CO-350 B DD	19075246	19081185	-
CHARACTERISTICS						
	Cold model	CO-350 COLD	19073545	19081186	-	
	Manual push button for final cold rinse	COLD	COLD			
VERSIONS						
	Drainage pump	B	CO-350 COLD B	19075247	19081187	-
	Peristaltic detergent doser	DD	CO-350 COLD DD	19075248	19081188	-
	Drainage pump and peristaltic detergent doser	B - DD	CO-350 COLD B DD	19075249	19081189	-

* Consult other possible factory versions.

ACCESSORIES	
Stands	See page. 354
Conversion kits	See page. 354
Water softeners	See page. 410
Baskets	See page. 411

Accessories supplied: Two 350x 350 mm base baskets, 1 supplement for plates and a small basket for cutlery.

		CONCEPT +		CONCEPT	
TECHNICAL DATA		COP-404	CO-402	CO-400	CO-350
WASH CYCLES					
Cycle Time	[s]	90/120/180	90/120/180	120	120
THEORETICAL CAPACITY*1					
Baskets	[cestas/h]	40	40	30	30
Glasses	[vasos/h]	1000	1000	750	480
WATER CONSUMPTION					
Tank capacity	[l]	15	15	15	11
Boiler capacity		4	4	4	4
Rinse water consumption *2	[l]	2.2	2.2	2.2	2.2
TEMPERATURES					
Tank temperature	[°C]	60	60	60	60
Rinse water temperature	[°C]	85	85	85	85
DIMENSIONS					
Width	[mm]	470	470	470	430
Depth	[mm]	525	525	525	480
With the door open	[mm]	846	846	846	660
Height *3	[mm]	720	720	720	840
Useful height	[mm]	270	270	270	220
Basket size	[mm]	400X400	400X400	400X400	350X350
ELECTRICAL SPECIFICATIONS					
Total connected load (Alt)	[kW]	3.06	3.06	3.06	2.66
Fuse protection	[A]	16	16	16	16
Wash pump (P1)	[kW]	0.26	0.26	0.26	0.26
Tank power	[kW]	2	2	2	2
Rinse pump	[kW]	0.13	-	-	-
Boiler power	[kW]	2.8	2.8	2.8	2.4
Connection (factory default)		230V/50Hz/1N~	230V/50Hz/1N~	230V/50Hz/1N~	230V/50Hz/1N~
5,41 mm					
Min. inlet temperature	[°C]	15	15	15	15
Max. inlet temperature	[°C]	60	60	60	60
Required grid pressure	[bar/kPA]	2-4/200-400	2-4/200-400	2-4/200-400	2-4/200-400
Max. drain height (only models B)	[mm]	500(B)	500(B)	500(B)	500(B)
Noise level (dBA)	[dBA]	<70	<70	<70	<70
Moisture protection		IPX4	IPX4	IPX4	IPX4
Net/gross weight	[kg]	35/42	35/42	35/42	30/37
Spray Arms		sst	sst	sst	Plast
ACCESSORIES					
Glasses basket	[un]	2	2	2	2
Small cutlery basket	[un]	1	1	1	1
Supplement for dishes	[un]	1	1	1	1

Accessories for glasswashers





Stand for glasswashers





- Made of stainless steel.

- It can be used to store the containers of detergent and rinse aid.

- Allows you to install the glasswashers without drain pump; the water drains by gravity.

MODEL	CODE	VALID FOR MODELS	CHARACTERISTICS	DIMENSIONS (mm)	€
 EVPL-47	19031298	CO-402 / CO-400	Capacity for 2 baskets 400x400	470x450x400	-
 EVPL-43	19031299	CO-350	Capacity for 2 baskets 350x350	430x405x400	-

Kit to transform the basic versions (except for soft versions)

MODEL	CODE	VALID FOR	DESCRIPTION	POWER (kW)	€
 DD 	19059327	Hood dishwashers Front-opening dishwashers Glasswashers	Peristáltic detergent doser	-	-
 B-AF 	19013376	Front-opening dishwashers Glasswashers	Kit drain pump - 50/60 hz.	35	-



Reliability and comfort
combined with high
efficiency.



Find out more!



Access the website



Sales brochure

Front loading dishwashers

Advance	357
Concept +	358
Concept.....	359
Accessories	364

Water connection:
It is advisable to introduce sanitary water in the dishwashers, with a temperature of 50 - 60 °C.

Water pressure:
Minimum: 2 bar = 2 kg/cm²
Maximum: 4 bar = 4 kg/cm²

Water softener:
All glass / dishwashers should be connected to a treated water supply when the local supply is over 10 HF / 6 HD.

Any issues derived from a bad installation that don't meet with the indicated conditions will not be considered as a warranty.



Front loading | Advance



AD-505

General characteristics

- Model with electronic and digital control.
- Digital display with information on programs, times and temperatures.
- Electronic programmer with help system for technical service.
- Rinse pump that guarantees a perfect hygienic result with a complete rinse at 80–85 °C (EFFIRINSE) in accordance with the safety and hygiene specifications of standard DIN10512.
- 60s, 90s, 120s and 'Glass' wash cycles.
- Theoretical maximum production of 60 baskets/hour.
- Tank with volume of 14 litres, with 1 kW heating element.
- Single-phase Multipower installation, with heating in the boiler which can be selected at time of installation, 1,9 / 2,8 / 3,73 / 5,6 kW.
- Multi-voltage: Allows the machine to be connected to a single-phase or three-phase voltage network (230 1N~/230 3~/400V 3N~).
- Simultaneous tank and boiler heating.
- Boiler with 5.6 kW heating element.
- Water consumption per 2.4 litre cycle.
- Stainless steel filter trays in the tank.
- IPX5 anti-humidity protection.

		MODEL	"CODE 50 HZ."	"CODE 60 HZ."	€
CHARACTERISTICS					
	Basic model	AD-505	19073539	19076140	-
	Rinse pump	A	A		
	Drainage pump	B	B		
	Peristaltic detergent doser	DD	DD		
	Voltage		MULTIVOLTAGE		
	Power	(kW)	MULTIPOWER		
	Dimensions	(mm)	600x600x830		
VERSIONS					
	Descaling system and tank with regeneration program	SOFT	AD-505 SOFT	19076139	19076141

ACCESSORIES	
Stands	See page 364
Conversion kits	See page 364
Water softeners	See page 410
Osmosis	See page 410
Baskets	See page 411



Accessories supplied: One CT-10 base basket, 1 CP-16/18 basket for plates and two cutlery holders.

Front loading | Concept+



General characteristics

- Model with electronic control and display of temperature, functions and errors.
- Control with help system for technical service.
- Thermostop system with rinse pump that guarantees a perfect hygienic result with a complete rinse at 80–85 °C (EFFIRINSE) in accordance with the safety and hygiene specifications of standard DIN10512.
- Air Brake check valve system type AA according to EN 1717/WRAS.
- 90s, 120s y 180s wash cycles.
- Theoretical maximum production of 40 baskets/hour.
- Tank with volume of 20 litres, with 2.8 kW heating element.
- Boiler with 5.6 kW heating element.
- Single-phase Multipower installation, with heating in the boiler which can be selected at time of installation, either 2,8 / 3,7 kW.
- Multi-voltage: Allows the machine to be connected to a single-phase or three-phase voltage network. (230 1N~/230 3~/400V 3N~).
- Double system of filter trays in the tank.
- IPX4 anti-humidity protection.

	MODEL	"CODE 50 HZ."	"CODE 60 HZ."	€	
CHARACTERISTICS					
 Basic model	COP-504	19073538	19076137	-	
Rinse pump	A	A			
Voltage	MULTIVOLTAGE				
Power	(kW)	MULTIPOWER			
Dimensions	(mm)	600x600x830			
VERSIONS					
Drainage pump	B	COP-504 B	19076134	19076138	-
Peristaltic detergent doser	DD	COP-504 DD	19076135	19081178	-
 Peristaltic detergent doser	B DD	COP-504 B DD	19076136	19081179	-
 UK type plug	CI	COP-504 CI	19083240	19083241	-
With pump, dispenser and British plug	B DD CI	COP-504 B DD CI	19076805	19083242	-

* Consult other possible factory versions.

ACCESORIES	
Stands	See page 364
Conversion kits	See page 364
Water softeners	See page 410
Osmosis	See page 410
Baskets	See page 411

Accessories supplied: One CT-10 base basket, 1 CP-16/18 basket for plates and two cutlery holders.

Front loading | Concept



General characteristics

- Model with electronic control and display of temperature, functions and errors.
- Control with help system for technical service.
- 90s, 120s y 180s wash cycles.
- Theoretical maximum production of 40 baskets/hour.
- Tank with volume of 20 litres, with 2.8 kW heating element.
- Single-phase Multipower installation, with heating in the boiler which can be selected at time of installation, either 2,8 / 3,7 kW.
- Multi-voltage: Allows the machine to be connected to a single-phase or three-phase voltage network. (230 1N~/230 3~/400V 3N~).
- Tray-filter in the wash tank.
- IPX4 anti-humidity protection.
- Thermal stop system which guarantees a rinse temperature of 85°C. Standard factory setting disabled.

	MODELO	"CÓDIGO 50 HZ."	"CÓDIGO 60 HZ."	€	
CHARACTERISTICS					
Basic model	CO-502	19073537	19076131	-	
Voltage	MULTIVOLTAGE				
Power (kW)	MULTIPOWER				
Dimensions (mm)	600x600x830				
VERSIONS					
Drainage pump	B	CO-502 B	19076115	19076132	-
Peristaltic detergent doser	DD	CO-502 DD	19076116	19076133	-
Drainage pump and peristaltic detergent doser	B - DD	CO-502 B DD	19076117	19083235	-
UK type plug	CI	CO-502 CI	19076118	19083236	-
With pump, detergent dispenser and British plug	B DD CI	CO-502 B DD CI	19076806	19076119	-

* Consult other possible factory versions.

ACCESORIES	
Stands	see pag 364
Conversion kits	see pag 364
Water softeners	see pag 410
Baskets	see pag 411



Accessories supplied: One CT-10 base basket, 1 CP-16/18 basket for plates and two cutlery holders.

Front loading | Concept



General characteristics

- Model with highly resistant control buttons.
- 90s, 120s y 180s wash cycles.
- Theoretical maximum production of 40 baskets/hour.
- Tank with volume of 20 litres, with 2.8 kW heating element.
- Single-phase Multipower installation, with heating in the boiler which can be selected at time of installation, either 2,8 / 3,7 kW.
- Multi-voltage: Allows the machine to be connected to a single-phase or three-phase voltage network. (230 1N~/230 3~/400V 3N~).
- Tray-filter in the wash tank.
- IPX4 anti-humidity protection.
- Thermal stop system which guarantees a rinse temperature of 85°C. Standard factory setting disabled.

		MODEL	"CODE 50 HZ."	"CODE 60 HZ."	€	
CHARACTERISTICS						
	Basic model	CO-501	19073534	19076111	-	
	Voltage	MULTIVOLTAGE				
	Power (kW)	MULTIPOWER				
	Dimensions (mm)	600x600x830				
VERSIONS						
	Drainage pump	B	CO-501 B	19076106	19076112	-
	Peristaltic detergent doser	DD	CO-501 DD	19076107	19076113	-
	Drainage pump and peristaltic detergent doser	B - DD	CO-501 B DD	19076108	19081175	-
	UK type plug	CI	CO-501 CI	19076109	19076114	-

* Consult other possible factory versions.

ACCESSORIES	
Stands	see pag 364
Conversion kits	see pag 364
Water softeners	see pag 410
Baskets	see pag 411





Accessories supplied: One CT-10 base basket, 1 CP-16/18 basket for plates and two cutlery holders.

Front loading | Concept



General characteristics

- Model with highly resistant control buttons.
- 120s wash cycle.
- Theoretical maximum production of 30 baskets/hour.
- Tank with volume of 20 litres, with 2.8 kW heating element.
- Water consumption per 2.4 litre cycle.
- Tray-filter in the wash tank.
- IPX4 anti-humidity protection.
- Thermal stop system which guarantees a rinse temperature of 85°C. Standard factory setting disabled.

	MODEL	"CODE 50 HZ."	"CODE 60 HZ."	€	
CHARACTERISTICS					
 Basic model	CO-500	19073532	19076101	-	
Voltage	230 V / 1N				
Power (kW)	MULTIPOWER				
Dimensions (mm)	600x600x830				
VERSIONS					
 Drainage pump	B	CO-500 B	19075467	19076102	-
 Peristaltic detergent doser	DD	CO-500 DD	19075468	19076103	-
 Drainage pump and peristaltic detergent doser	B - DD	CO-500 B DD	19075469	19076104	-

* Consult other possible factory versions.

ACCESORIES	
Stands	see pag 364
Conversion kits	see pag 364
Water softeners	see pag 410
Baskets	see pag 411

Accessories supplied: One CT-10 base basket, 1 CP-16/18 basket for plates and two cutlery holders.

Foodservice | Dishwashing

		ADVANCE	CONCEPT +		CONCEPT	
Technical data		AD-505	COP-504	CO-502	CO-501	CO-500
WASH CYCLES						
Cycle Time	[s]	60/90/180	90/120/180	90/120/180	90/120/180	120
THEORETICAL CAPACITY*1						
Baskets	[cestas/h]	60	40	40	40	30
Plates	[platos/h]	1080	720	720	720	540
Glasses	[vasos/h]	2160	1440	1440	1440	1080
WATER CONSUMPTION						
Tank capacity	[l]	14	20	20	20	20
Boiler capacity		7	7	7	7	7
Rinse water consumption per cycle *2	[l]	2.4	2.4	2.4	2.4	2.4
TEMPERATURES						
Tank temperature	[°C]	60 (55-71)	60	60	60	60
Rinse water temperature	[°C]	82 (65-85)/PG 65	85	85	85	85
DIMENSIONS						
Width	[mm]	600	600	600	600	600
Depth	[mm]	602	602	602	602	602
With the door open	[mm]	1020	1020	1020	1020	1020
With water softener		1060	1060	1060	1060	1060
Height *3	[mm]	840	840	840	840	840
Useful height	[mm]	360	360	360	360	360
Basket size	[mm]	500X500	500X500	500X500	500X500	500X500
ELECTRICAL SPECIFICATIONS						
Total connected load (Alt/Sim)	[kW]	See table	See table	See table	See table	See table
Fuse protection	[A]	See table	See table	See table	See table	See table
Wash pump (P1)	[kW]	0.59	0.59	0.59	0.59	0.59
Tank power	[kW]	1	2,8	2,8	2,8	2,8
Rinse pump	[kW]	0.25	0.25	-	-	-
Boiler power	[kW]	See table	See table	See table	See table	2,8
Connection (factory default)		230V/50Hz/1N~	230V/50Hz/1N~	230V/50Hz/1N~	230V/50Hz/1N~	230V/50Hz/1N~
OTHER INFORMATION						
Min. inlet temperature	[°C]	15	15	15	15	15
Max. inlet temperature	[°C]	60	60	60	60	60
Required grid pressure	[bar/kPA]	1.0-4.0/100-400	1.0-4.0/100-400	2.0-4.0/200-400	2.0-4.0/200-400	2.0-4.0/200-400
Max. drain height (only B models)	[mm]	500	500(B)	500(B)	500(B)	500(B)
Noise level (dBA)	[dBA]	<65	<65	<65	<65	<65
Moisture protection		IPX5	IPX4	IPX4	IPX4	IPX4
Net/gross weight	[kg]	60/77	60/77	58/75	58/75	58/75
Spray Arms		sst	sst	sst	sst	sst
ACCESSORIES						
Glasses basket	[un]	1	1	1	1	1
Small cutlery basket	[un]	2	2	2	2	1
Baskets for plates	[un]	1	1	1	1	1

*1 Customer circumstances (inlet water temperature/electrical connection) may reduce the values indicated here.

*2 Non-binding information. The actual rinse water requirements may vary depending on site conditions.

*3 The adjustable feet allow the vertical dimensions to be raised as required up to 25 mm.

	VOLTAGE	FACTORY DEFAULT	FUSE PROTECTION	TOTAL AMP.	TOTAL CONNECTED LOAD	CONNECTION	TANK POWER	BOILER POWER	WASH PUMP POWER
AD-505	380 V - 415 V / 3N~		16 A	15 A	7.2 kW	SIM	1 kW	5,6 kW	0.6 kW
	220 V - 240 V / 1N~		13 A	10.7 A	2.5 kW	ALT	1 kW	1.9 kW	0.6 kW
	220 V - 240 V / 1N~	FD	16 A	15 A	3.5 kW	SIM	1 kW	1.9 kW	0.6 kW
	220 V - 240 V / 1N~		20 A	19.1 A	4.4 kW	SIM	1 kW	2.8 kW	0.6 kW
	230 V / 3~		25 A	21 A	7.2 kW	SIM	1 kW	5.6 kW	0.6 kW
COP-504	380 V - 415 V / 3N~		16 A	14,7 A	6.2 kW	ALT	2.8 kW	5.6 kW	0.6 kW
CO-502	220 V - 240 V / 1N~	FD	16 A	14.7 A	3.4 kW	ALT	2.8 kW	2.8 kW	0.6 kW
CO-501	220 V - 240 V / 1N~		20 A	18.8 A	4.3 kW	ALT	2.8 kW	3.7 kW	0.6 kW
	230 V / 3~		20 A	16.6 A	6.2 kW	ALT	2.8 kW	5.6 kW	0.6 kW
CO-500	220 V - 240 V / 1N~	FD	16 A	14.7 A	3.4 kW	ALT	2.8 kW	2.8 kW	0.6 kW



Accessories for front loading







Stand for front loading. General characteristics

- Made of stainless steel.
- Valid for the front loading dishwashers of the E-VO Generation.
- Space for baskets 500 x 500 mm.
- Capacity for 3 baskets height 110 mm (CT-10, CP-16/18, CV-16/105...).
- It can be used to store the containers of detergent and rinse aid.
- Allows you to install the dishwasher without drain pump; the water drains by gravity.



MODEL	CODE	CHARACTERISTICS	DIMENSIONS (mm)	€
EVPL-60	19004660	Capacity for 3 baskets 500x500	600x600x400	-

Transformation kits for E-VO dishwashers

Kit to transform the basic versions (except for soft versions)

MODEL	CODE	VALID FOR	DESCRIPTION	POWER (kW)	€
 DD 	19059327	HOOD DISHWASHERS FRONT-OPENING DISHWASHERS GLASSWASHERS	PERISTÁLTIC DETERGENT DOSER	-	-
 B-AF 	19013376	FRONT-OPENING DISHWASHERS GLASSWASHERS	KIT DRAIN PUMP - 50/60 Hz.	35	-

Kit trays-filter for wash tank

MODEL	CODE	DESCRIPTION	€
 K-BF-500 	19036304	KIT 2 TRAYS-FILTER FOR WASH TANK	-

Optional kit for marine version

MODEL	CODE	VALID FOR	CHARACTERISTICS	€
KIT MARINE AF	19036061	COP-504, CO-502, CO-501, CO-500	Connection for ships	-



Simplicity and agility
for large quantities
and intensive use.



Find out more!



Access the website



Sales brochure

Hood-type dishwashers

Advance	367
Concept +	369
Concept.....	370
Accessories	374

Water connection:
It is advisable to introduce sanitary water in the dishwashers, with a temperature of 50 - 60 °C.

Water pressure:
Minimum: 2 bar = 2 kg/cm²
Maximum: 4 bar = 4 kg/cm²

Water softener:
All glass / dishwashers should be connected to a treated water supply when the local supply is over 10 HF / 6 HD.

Any issues derived from a bad installation that don't meet with the indicated conditions will not be considered as a warranty.



Hood-type | Advance



AD-125

General characteristics

- Model with electronic and digital control.
- Digital display with information on programs, times and temperatures.
- Electronic programmer with help system for technical service.
- Rinse pump which guarantees a perfect hygiene result with complete linear rinse cycle at 85°C. (EFFIRINSE) de acuerdo con las especificaciones de seguridad e higiene de la norma DIN10512.
- 55s, 75s, 120s, 480s and 'Glass' wash cycles.
- Theoretical maximum production of 65 baskets/hour (1170 plates/h).
- Program for tank emptying cycle.
- Double-walled Hood with special compressed insulating material.
- Tank with volume of 28 litres, with 2.1 kW heating element.
- Boiler with volume of 9 litres, with 9 kW heating element.
- Simultaneous tank and boiler heating.
- Maximum Total power: 11.85 kW (simultaneous).
- Drainage pump - power 70 W - tank emptying program.
- Rinse aid doser incorporated.
- Rinse aid doser incorporated.
- IPX5 anti-humidity protection.

	MODEL	"CODE 50 HZ."	"CODE 60 HZ."	€	
CHARACTERISTICS					
 Basic model	AD-125	19073921	19075047	-	
Rinse pump	A	A			
Drainage pump	B	B			
Peristaltic detergent doser	DD	DD			
Voltage		MULTIVOLTAGE			
Power	(kW)	MULTIPOWER			
Dimensions	(mm)	630 x 750 x 1.465			
VERSIONS					
 Descaling system and tank with regeneration program	SOFT	AD-125 SOFT	19075295	19075298	-
CHARACTERISTICS					
Model with recovery system	AD-125 HRS	19075296	19075299	-	
Heat recovery system	HRS	HRS			
Dimensions	(mm)	630 x 750 x 1.990			
VERSIONS					
 Descaling system and tank with regeneration program and detergent dispenser	SOFT	AD-125 SOFT HRS	19074195	19075048	-
* Consult other possible factory versions.					
ACCESORIES					
Entry-exit tables	see page 374				
Conversion kits	see page 376				
Water softeners	see page 410				
Osmosis	see page 410				
Baskets	see page 411				

Hood-type | Advance



General characteristics

- Model with electronic and digital control.
- Digital display with information on programs, times and temperatures.
- Electronic programmer with help system for technical service.
- Rinse pump which guarantees a perfect hygiene result with complete linear rinse cycle at 85°C. (EFFIRINSE) de acuerdo con las especificaciones de seguridad e higiene de la norma DIN10512.
- 55s, 75s, 120s and 480s wash cycles.
- Double-walled Hood with special compressed insulating material.
- Tank with volume of 28 litres, with 2.1 kW heating element.
- The ECO version Hood-Type dishwashers are fitted with an external hot water generator, gas heated, model GWB-20.
- The generator replaces the electric rinse boiler in the dishwasher, bringing a significant saving in electricity consumption.

	MODEL	*CODE 50 HZ.*	*CODE 60 HZ.*	€
CHARACTERISTICS				
Basic model	AD-125 ECO	19075300	19075301	-
Rinse pump	A	A		
Drainage pump	B	B		
Peristaltic detergent doser	DD	DD		
Voltage	MULTIVOLTAGE			
Power	(kW)	2,70		
Dimensions	(mm)	630 x 750 x 1.465		

(1) Note on codes

When placing your order, to the machine code, please add the generator code GWB-20 (according to the type of gas and electrical frequency), included in the price.

Gas hot water generator GWB-20

Forced draught burner and double safety valve. Electronic control of temperature and water levels. Automatic limescale removal. Automatic tank emptying.

	MODEL	*CODE 50 HZ.*	*CODE 60 HZ.*	€	
Power	(kW)	20			
Dimensions	(mm)	432x548x770			
Butane/propane gas	LPG	GWB-20 LPG	19010831	19044806	-
Natural gas	GN	GWB-20 GN	19038551	19044807	-



Accessories supplied: One CT-10 base basket, 1 CP-16/18 basket for plates and two cutlery holders.

Hood-type | Concept+



General characteristics

- Model with electronic control and display of temperature, functions and errors.
- Control with help system for technical service.
- Thermostop system with rinse pump that guarantees a perfect hygienic result with a complete rinse at 80–85 °C (EFFIRINSE) in accordance with the safety and hygiene specifications of standard DIN10512..
- Air Brake check valve system type AA according to EN 1717/WRAS.
- 55s, 75s, 120s and 600s wash cycles.
- Theoretical maximum production of 65 baskets/hour (1170 plates/h).
- Tank with volume of 33 litres, with 4.5 kW heating element.
- Boiler with volume of 9 litres, with 9 kW heating element.
- Alternating or simultaneous tank and boiler heating.
- Maximum Total power: 9.75 kW (alternating) or 14.75 kW (simultaneous).
- IPX4 anti-humidity protection.

	MODEL	*CÓDIGO 50 HZ.*	*CÓDIGO 60 HZ.*	€		
CHARACTERISTICS						
	Basic model	COP-144	19073920	19075045	-	
	Rinse pump	A	A			
	Voltage	MULTIVOLTAGE				
	Power	(kW)	9,75 / 14,25			
	Dimensions	(mm)	630 x 750 x 1.465			
VERSIONS						
	Drainage pump	B	COP-144 B	19075288	19075292	-
	Peristaltic detergent doser	DD	COP-144 DD	19075289	19075293	-
	Drainage pump and detergent doser	B - DD	COP-144 B DD	19075290	19075294	-
	CHARACTERISTICS					
	Model with recovery system	COP-144 HRS	19075044	19075046	-	
	Heat recovery system	HRS	HRS			
	Dimensions	(mm)	630 x 750 x 1.990			
VERSIONS						
	Drainage pump and detergent doser	B - dd	COP-144 HRS B DD	19075291	19081123	-

* Consult other possible factory versions.

ACCESORIES	
Entry-exit tables	see page 374
Conversion kits	see page 376
Water softeners	see page 410
Osmosis	see page 410
Baskets	see page 411



Accessories supplied: One CT-10 base basket, 1 CP-16/18 basket for plates and two cutlery holders.

Hood-type | Concept



General characteristics

- Model with electronic control and display of temperature, functions and errors.
- 55s, 75s, 120s and 600s wash cycles.
- Theoretical maximum production of 65 baskets/hour (1170 plates/h).
- Tank with volume of 33 litres, with 4.5 kW heating element.
- Boiler with volume of 9 litres, with 9 kW heating element.
- Alternating or simultaneous tank and boiler heating.
- Thermal stop system which guarantees a rinse temperature of 85°C. Standard factory setting disabled.
- Maximum Total power: 9.75 kW (alternating) or 14.75 kW (simultaneous).
- IPX4 anti-humidity protection.

		MODEL	"CODE 50 HZ."	"CODE 60 HZ."	€	
CHARACTERISTICS						
	Basic model	CO-142	19073919	19075042	-	
	Voltage	MULTIVOLTAGE				
	Power (kW)	9,75 / 14,25				
	Dimensions (mm)	630 x 750 x 1.465				
VERSIONS						
	Drainage pump	B	CO-142 B	19075277	19075285	-
	Peristaltic detergent doser	DD	CO-142 DD	19075278	19075286	-
	Drainage pump and detergent doser	B - DD	CO-142 B DD	19075279	19075287	-
CHARACTERISTICS						
	Model with recovery system	CO-142 HRS	19075041	19075043	-	
	Heat recovery system	HRS	HRS			
	Dimensions (mm)	630 x 750 x 1.990				
VERSIONS						
	Drainage pump and detergent doser	B - DD	CO-142 HRS B DD	19075282	19081120	-

* Consult other possible factory versions.

ACCESSORIES	
Entry-exit tables	see page. 374
Conversion kits	see page. 376
Water softeners	see page. 410
Baskets	see page. 411



Accessories supplied: One CT-10 base basket, 1 CP-16/18 basket for plates and two cutlery holders.

Hood-type | Concept



General characteristics

- Model with highly resistant control buttons.
- 90s, 120s, 180s and 600s wash cycles.
- Theoretical maximum production of 40 baskets/hour.
- Tank with volume of 33 litres, with 4.5 kW heating element.
- Boiler with volume of 9 litres, with 6 kW heating element.
- Alternating or simultaneous tank and boiler heating.
- Thermal stop system which guarantees a rinse temperature of 85°C. Standard factory setting disabled.
- Maximum Total power: 6.75 kW (alternating) or 11.25 kW (simultaneous).
- IPX4 anti-humidity protection.

		MODEL	"CODE 50 HZ."	"CODE 60 HZ."	€	
CHARACTERISTICS						
	Basic model	CO-110	19073548	19075029	-	
	Voltage	MULTIVOLTAGE				
	Power (kW)	6,75 / 11,25				
	Dimensions (mm)	630 x 750 x 1.465				
VERSIONS						
	Drainage pump	B	CO-110 B	19075270	19075274	-
	Peristaltic detergent doser	DD	CO-110 DD	19075271	19075275	-
	Drainage pump and detergent doser	B - DD	CO-110 B DD	19075272	19075276	-
	CHARACTERISTICS					
	Model with recovery system	CO-110 HRS	19075016	19075040	-	
	Heat recovery system	HRS	HRS			
	Dimensions (mm)	630 x 750 x 1.990				
VERSIONS						
	Drainage pump and detergent doser	B - DD	CO-110 HRS B DD	19075273	19081101	-

* Consult other possible factory versions.

ACCESORIES	
Entry-exit tables	see page 374
Conversion kits	see page 376
Water softeners	see page 410
Baskets	see page 411

Accessories supplied: One CT-10 base basket, 1 CP-16/18 basket for plates and two cutlery holders.

Foodservice | Dishwashing

		ADVANCE		CONCEPT +		CONCEPT
TECHNICAL DATA		AD-125	AD-125 eco	COP-144	CO-142	CO-110
WASH CYCLES						
Cycle Time	[s]	55/75/120/480	55/75/120/480	55/75/120/600	55/75/120/600	90/120/180/600
THEORETICAL CAPACITY*1						
Baskets	[cestas/h]	65	65	65	65	40
Plates	[platos/h]	1170	1170	1170	1170	720
Glasses	[vasos/h]	2340	2340	2340	2340	1440
WATER CONSUMPTION						
Tank capacity	[l]	28	28	33	33	33
Boiler capacity		10	13	10	9	9
Rinse water consumption per cycle *2	[l]	2.4	2.4	2.4	2.4	2.4
TEMPERATURES						
Tank temperature	[°C]	60 (55-71)	60 (55-71)	60	60	60
Rinse water temperature	[°C]	82 (65-85)	82 (65-85)	85	85	85
DIMENSIONS						
Width	[mm]	712	712	712	712	712
Depth	[mm]	750 (827)	750 (827)	750 (827)	750 (827)	750 (827)
Height with hood closed *3	[mm]	1465	1465	1465	1465	1465
Height with hood open	[mm]	1940	1940	1940	1940	1940
Height with HRS	[mm]	1990	1990	1990	1990	1990
Operating height	[mm]	820-890	820-890	820-890	820-890	820-890
Useful height	[mm]	430	430	430	430	430
Basket size	[mm]	500x500	500x500	500x500	500x500	500x500
ELECTRICAL SPECIFICATIONS						
Total power connected(Alt/Sim)	[kW]	Ver tabla	Ver tabla	Ver tabla	Ver tabla	Ver tabla
Fuse protection	[A]	Ver tabla	Ver tabla	Ver tabla	Ver tabla	Ver tabla
Wash pump (P1)	[kW]	0.75	0.75	0.75	0.75	0.75
Tank power	[kW]	2.1	2.1	4.5	4.5	4.5
Rinse pump	[kW]	0.25	0.25	0.25	-	-
Boiler power	[kW]	9	-	9	9	6
Connection (factory default)		400V/50Hz/3N~	400V/50Hz/3N~	400V/50Hz/3N~	400V/50Hz/3N~	400V/50Hz/3N~
OTHER INFORMATION						
Min. inlet temperature	[°C]	15	15	15	15	15
Max. inlet temperature	[°C]	60	60	60	60	60
Grid pressure	[bar/kPA]	1.0-4.0/100-400	1.0-4.0/100-400	1.0-4.0/100-400	2.0-4.0/200-400	2.0-4.0/200-400
Grid pressure requerida para HRS	[bar/kPA]	2.0-4.0/200-400	2.0-4.0/200-400	2.0-4.0/200-400	2.0-4.0/200-400	2.0-4.0/200-400
Max. drain height (only B models)	[mm]	600	600	130/600(B)	130/600(B)	130/600(B)
Noise level (dBA)	[dBA]	<65	<65	<70	<70	<70
Moisture protection		IPX5	IPX5	IPX4	IPX4	IPX4
Net/gross weight	[kg]	111/129	109/127	97/115	95/113	95/113
Net/gross weight with HRS	[kg]	127/147	125/145	113/133	111/131	111/131
Spray Arms		sst	sst	sst	sst	sst
ACCESSORIES						
Glasses basket	[un]	1	1	1	1	1
Small cutlery basket	[un]	2	2	2	2	2
Baskets for plates	[un]	1	1	1	1	1

- * 1 Customer circumstances (inlet water temperature/electrical connection) may reduce the values indicated here.
- * 2 Non-binding information. The actual rinse water requirements may vary depending on site conditions.
- * 3 The adjustable feet allow the vertical dimensions to be raised as required up to 25 mm.
- * 4 4 Models with energy recovery (HRS): Total kW + 0.5 kW & Total Amp.+ 0.4 A.

	VOLTAGE	FACTORY DEFAULT	FUSE PROTECTION	TOTAL AMP.	TOTAL CONNECTED LOAD	CONNECTION	TANK POWER	BOILERPOWER	WASH PUMP POWER
AD-125	380 V - 415 V / 3N~	FD	20 A	18.7 A	11,85 kW	SIM	2.1 kW	9 kW	0.75 kW
	220 V - 240 V / 1N~		32 A	26.7 A	6,35 kW	SIM	1.1 kW	4.5 kW	0.75 kW
	220 V - 240 V / 1N~		40 A	34.8 A	8,15 kW	SIM	1.4 kW	6 kW	0.75 kW
	230 V / 3~		40 A	30,5 A	11,85 kW	SIM	2.1 kW	9 kW	0.75 kW
AD-125 eco	380 V - 415 V / 3N~	FD	16 A	5.7 A	2,85 kW	-	2.1 kW	-	0.75 kW
	220 V - 240 V / 1N~		16 A	11.8 A	2,85 kW	-	2.1 kW	-	0.75 kW
	230 V / 3~		16 A	7.9 A	2,85 kW	-	2.1 kW	-	0.75 kW
"COP-144 CO-142"	380 V - 415 V / 3N~		20 A	15.7 A	9,75 kW	ALT	4.5 Kw	9 kW	0.75 kW
	380 V - 415 V / 3N~	FD	25 A	22.2 A	14,25 kW	SIM	4.5 Kw	9 kW	0.75 kW
	220 V - 240 V / 1N~		25 A	22.2 A	5,25 kW	ALT	2.3 Kw	4.5 kW	0.75 kW
	220 V - 240 V / 1N~		32 A	28.7 A	6,75 kW	ALT	3 Kw	6 kW	0.75 kW
	220 V - 240 V / 1N~		50 A	41.8 A	9,75 kW	ALT	4.5 Kw	9 kW	0.75 kW
	220 V - 240 V / 1N~		40 A	32 A	7,55 kW	SIM	2.3 Kw	4.5 kW	0.75 kW
	220 V - 240 V / 1N~		50 A	41.8 A	9,75 kW	SIM	3 Kw	6 kW	0.75 kW
	230 V / 3~		32 A	25.2 A	9,75 kW	ALT	4.5 Kw	9 kW	0.75 kW
	230 V / 3~		40 A	36.5 A	14,25 kW	SIM	4.5 Kw	9 kW	0.75 kW
CO-110	380 V - 415 V / 3N~		16 A	11.3 A	6,75 kW	ALT	4.5 Kw	6 kW	0.75 kW
	380 V - 415 V / 3N~	FD	20 A	17.8 A	11,25 kW	SIM	4.5 Kw	6 kW	0.75 kW
	220 V - 240 V / 1N~		20 A	15.7 A	3,75 kW	ALT	2.25 Kw	3 kW	0.75 kW
	220 V - 240 V / 1N~		25 A	20 A	4,75 kW	ALT	3 Kw	4 kW	0.75 kW
	220 V - 240 V / 1N~		32 A	28.7 A	6,75 kW	ALT	4.5 Kw	6 kW	0.75 kW
	220 V - 240 V / 1N~		32 A	25.7 A	6,05 kW	SIM	2.25 Kw	3 kW	0.75 kW
	220 V - 240 V / 1N~		40 A	33 A	7,75 kW	SIM	3 Kw	4 kW	0.75 kW
	220 V - 240 V / 1N~		50 A	48,3 A	11,25 kW	SIM	4.5 Kw	6 kW	0.75 kW
	230 V / 3~		20 A	17.7 A	6,75 kW	ALT	4.5 Kw	6 kW	0.75 kW
	230 V / 3~		32 A	29 A	11,25 kW	SIM	4.5 Kw	6 kW	0.75 kW

Tables for hood type dishwashers

Entry and exit tables



General characteristics





- Wide range of entry / exit and prewashing tables, to provide solutions for every need and space.
- Designed for 500 x 500 mm dishwashing baskets.
- Quick installation and easy connection to the dishwasher.
- No holes on the surface.

- Constructed in AISI-304 stainless steel (18/10). 40 x 40 mm square tubular legs in AISI-304 stainless, adjustable in height.
- Deep anti-drip profiles completely folded with lower edge for safe and easy cleaning.

Equipment:

- 100 mm splashback (P).
- Embedded bowl (F), fully integrated in the top.
- Bowl dimensions: 450 x 450 x 250 mm.
- Lower rack (E).
- Waste scraping hole with rubber ring (O).
- Shower kit (GD) for prewashing tables.

Entry / exit tables

	MODEL	CODE	TO PLACE ON THE	EQUIPMENT (*)	DIMENSION (mm)	€
	MP-620-I	19053197	Left	P - E	620x740x880	-
	MP-620-D	19053199	Right	P - E	620x740x880	-
	MLP-1200-I E-VO	19058358	Left	P - E	1.200x740x880	-
	MLP-1200-D E-VO	19058359	Right	P - E	1.200x740x880	-

(*): E: Lower rack / P: Removable splashback





Union element for hood dishwashers

	MODEL	CODE	DESCRIPTION	DIMENSION (mm)	€
	MP-140	19061430	Element for joining two hood dishwasher in series	140x740x350	-

Prewashing tables

- Worktop 1,5 mm thick.
- Lower rack 1 mm thick
- Sink welded to the countertop

- Lower rack welded, not removable
- 4 welded legs, not removable

	MODEL	CODE	TO PLACE ON THE	EQUIPMENT (*)	DIMENSION (mm)	€
	MF-700-I E-VO	19059285	Left	P - E - F	700x740x880	-
	MF-700-D E-VO	19059286	Right	P - E - F	700x740x880	-
	MF-1200-I E-VO	19059287	Left	P - E - F	1.200x740x880	-
	MF-1200-D E-VO	19059288	Right	P - E - F	1.200x740x880	-
	MFD-1200-I E-VO	19059289	Left	P - E - F - O	1.200x740x880	-
	MFD-1200-D E-VO	19059290	Right	P - E - F - O	1.200x740x880	-
	MFD-1500-I E-VO	19059291	Left	P - E - F - O	1.500x740x880	-
	MFD-1500-D E-VO	19059292	Right	P - E - F - O	1.500x740x880	-

(*): E: Lower rack / P: Splashback / F: Bowl / O: Waste scraping hole.

Shower kit for prewashing tables

	MODEL	CODE	VALID FOR TABLES	€
	GD2 E	19085069	MF-700 / MF-1200 / MFD-1200 / MFD-1500	-

Examples of assembly



AD-125 + MP-620-I + MP-620-D



CO-110 + MF-700-I + GD2 E + MLP-1200-D



CO-142 + CO+142 +
MLP-1200-I E-VO + MP-140 + MFD-1200-D E-VO
SERIES ASSEMBLY OF TWO HOOD DISHWASHER

MODELO	CODE	DESCRIPTION	€
REPLACEMENT KIT	19059308	Kit of elements to adapt the old tables to a 2019 hood dishwasher	-

Schemes of different types of assembly

Linear assembly

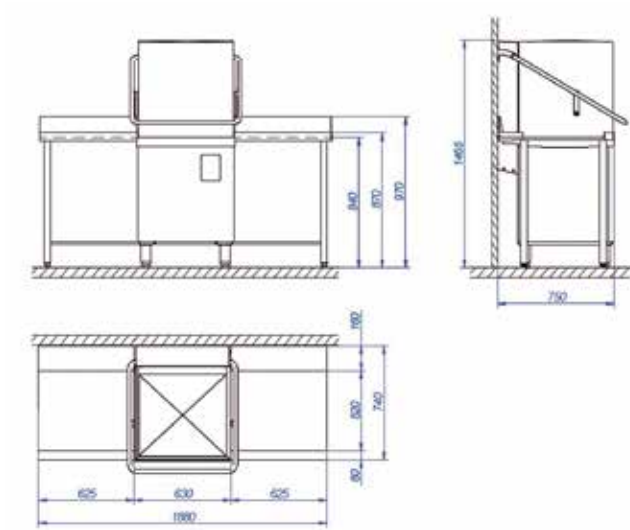



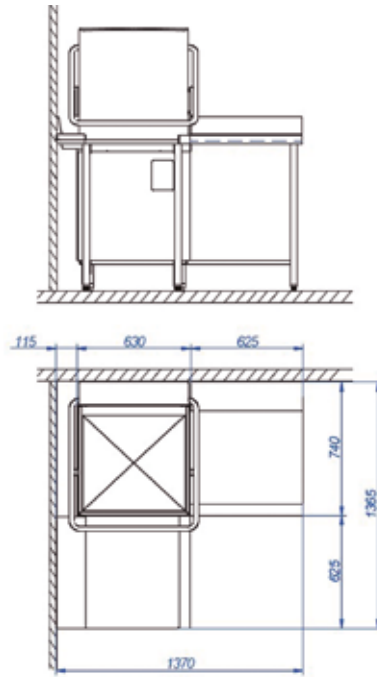

Assembly in corner



Kits to transform

Kit to transform the basic versions

MODEL	CODE	DESCRIPTION	€
 DD 	19059327	PERISTALTIC DETERGENT DOSER	-
 B-CAP 	19059326	KIT DRAIN PUMP HOOD TYPE	-

Optional marine kit for ships

MODEL	CODE	VALID FOR	CHARACTERISTICS	€
KIT MARINE HOOD	19036059	AD-125, COP-144, CO-142, CO-110	Connection for ships 440V	-



Robust and powerful
for high degrees of
dirtiness.



Find out more!



Access the website

Utensilwashers

Utensilwashers LP Series	317
Utensilwashers LP-ECO Series	317
Accessories	318

Water connection:
It is advisable to introduce sanitary water in the dishwashers, with a temperature of 50 - 60 °C.

Water pressure:
Minimum: 2 bar = 2 kg/cm²
Maximum: 4 bar = 4 kg/cm²

Water softener:
All glass / dishwashers should be connected to a treated water supply when the local supply is over 10 HF / 6 HD.

Any issues derived from a bad installation that don't meet with the indicated conditions will not be considered as a warranty.

Utensilwashers



General characteristics

LP SERIES

- LP Series for the cleaning of utensils and kitchen recipients.
- Made with double skinned of stainless steel 18/10 (AISI-304).
- Electronic control panel.
- Rotating wash and rinse arms.
- Wash temperature 55°C and rinse 80°C.
- Wash cycles: 2' - 4' - 6'.
- Continuous wash cycle up to 12'.

- Maximum theoretical productivity: 30 racks/hour.
- Thermostop system.
- Control of the rinse pressure.
- Built-in detergent dispenser and rinse dispenser.
- Electric connection: 400 V - III+N+E - 50 Hz.
- Thanks to the drain pump, the self-cleaning cycle is automatic.
- Rinsing pump that guarantees a perfect hygienic result and constant pressure control during the rinse.
- DD: Detergent dispensers and

brightener included.

- B: Drain pump included.

LP-ECO SERIES

- Similar features, except:
 - Do not include a built-in drain pump.
 - Without control of rinse pressure.
 - Without detergent dispenser.
 - Without rinse dispenser.
 - Without self cleaning cycle.
- Fixed cycles duration: 2' - 4' - 8'.



MODEL	CODE	BASKET SIZE (mm)	USABLE HIGHT (mm)	TANK CAPACITY (L)	WATER CONSUMPTION (L/CYCLE)	POWER (KW)	DIMENSIONS (mm)	€
LP-SERIES								
LP-61 B DD	19076870	500x600	400	23	3	6,7	600x700x1.290	-
LP-62 B DD	19076872	560x630	650	37	3	7,5	720x780x1.730	-
LP-62 B DD HRS	19076873	560x630	650	37	3	7,5	720x780x1.960	-
LP-63 B DD	19072567	560x630	850	37	3	7,5	720x780x1.930	-
LP-63 B DD HRS	19076875	560x630	850	37	3	7,5	720x780x2.160	-
LP-70 B DD	19075071	700x700	850	68	4	10,7	850x850x1.960	-
LP-70 B DD HRS	19076876	700x700	850	68	4	10,7	850x850x2.160	-
LP-130 B DD	19074725	1.320x700	850	131	6	15,9	1.470x850x1.960	-
LP-130 B DD HRS	19076877	1.320x700	850	131	6	15,9	1.470x850x2.160	-
LP-SERIES ECO								
LP-61 DD ECO	19003005	500x600	400	23	3	6,7	600x700x1.228	-
LP-62 DD ECO	19003006	560x630	650	37	3	7,5	719x782x1.727	-

Accessories supplied: One basket.

Accessories for utensilwashers

MODEL	CODE	DESCRIPTION	€
CT-LP61B	19023165	Basket for LP-61 B	-
CT-LP62	19010251	Basket for LP-62 and LP-63 H	-
CT-LP70	19010252	Basket for LP-70	-
CT-LP130	19011085	Basket for LP-130	-
SMP	19010253	Support for pastry dispenser	-
ARM8	19010254	Frame support for 8 trays	-
CU150	19010255	Cutlery container (150 x 150 mm)	-



Robust and reliable machines, with an increased output capacity.



Find out more!



Access the website



Comercial video



Sales brochure

Rack conveyor

Compact dishwashers	383
Modular dishwashers.....	387
Accessories	393

Water connection:
It is advisable to introduce sanitary water in the dishwashers, with a temperature of 50 - 60 °C.

Water pressure:
Minimum: 2 bar = 2 kg/cm²
Maximum: 4 bar = 4 kg/cm²

Water softener:
All glass / dishwashers should be connected to a treated water supply when the local supply is over 10 HF / 6 HD.

Any issues derived from a bad installation that don't meet with the indicated conditions will not be considered as a warranty.

Rack conveyor | Compact dishwashers









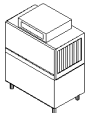

General characteristics

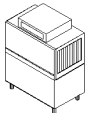
- All the main parts are manufactured in AISI-304 anti-corrosion stainless steel: tanks, washing and rinsing arms, rinsing jets, doors, basket conveyance system, boiler and metal tubes.
- Upwards-opening double panel door.
- Tank tray filters made of AISI-304 stainless steel, easy to access and remove for cleaning and access to the tank.
- Safety filter for pump suction.
- Rinsing boiler with heat insulation.
- Easy access for installation. Electrovalve located on one side (no need to remove panels to connect the machine).
- Electrical panel designed for easy connection of dosers for liquid and solid detergents, rinse aid, limit switches, supplementary emergency stop button.
- Washing arms easily removable as a set, for cleaning, with a plug on each branch providing access for cleaning inside.
- Rinse jets easily dismountable and removable.
- System of electronic regulation of speeds by means of frequency shifter.
- Configurable electronic temperature control:
 - Wash (50 - 65 °C)
 - Rinse (70 - 85 °C)
 - Guarantor of rinse at 85 °C.
- Pressure regulator for flow control.
- Emergency stop button incorporated.
- Extra anti-entrapment protection system at the entrance, mounted on the AS-260 splash guard supplement (optional).
- Open door blocking system.
- IPX4 protection system.
- System for detection of blockage of conveyor carriage and automatic reverse function.
- High-power washing system with 4 upper and 4 lower washing branches.
- 3 washing programs: deep, medium and high-capacity.
- Double effect rinse.
- Energy-saving system: reduces consumption by halting operation of the pumps, and by passing the heating of the rinse to stand-by mode (70 °C).
- Auto-timer which deactivates the conveyor motor after a pre-set period of inactivity (10 minutes).
- Energy saving system in the wash: the wash does not start up until it detects the passage of the basket.
- Rinse saving system. The rinse stops when the basket has left, saving water and energy.
- Limit switch included.

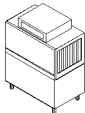
Equipment included:

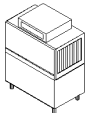
- 2 base baskets, CT-10
- 2 baskets for plates CP-16/18, 1 basket for glasses CV-16/105, 1 basket for cutlery CT-10 R

MODEL	HZ.	CODE	ENTRANCE (*)	WATER SUPPLY	PROGRAMS (BASKETS/H)			INTERNAL ZONES (**)	WATER CONSUMPTION (L/H)	ELECTRICAL POWER (kW)	DIMENSIONS (mm)	€
					DEEP	MEDIUM	HIGH-CAPACITY					
 CCO-120-L- HW	50	19048203	L	>50°	80	100	120		210	19.45	1,180 x 790 x 1,550	-
	60	19048571										
 CCO-120-R- HW	50	19048204	R	>50°	80	100	120	 LP + A	210	19.45	1,180 x 790 x 1,550	-
	60	19048573										
 CCO-120-L- CW	50	19045325	L	<50°	80	100	120		210	28.45	1,180 x 790 x 1,550	-
	60	19048217										
 CCO-120-R- CW	50	19046527	R	<50°	80	100	120	 LP + A	210	28.45	1,180 x 790 x 1,550	-
	60	19047158										

(*) Entry of baskets:
L: Entrance from the Left of the machine.
R: Entrance from the Right of the machine.

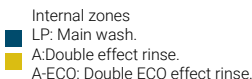
(**) Internal zones

LP: Main wash.
A: Double effect rinse.
A-ECO: Double ECO effect rinse.

Rack conveyor | Compact dishwashers



General characteristics

- All the main parts are manufactured in AISI-304 anti-corrosion stainless steel: tanks, washing and rinsing arms, rinsing jets, doors, basket conveyance system, boiler and metal tubes.
- Upwards-opening double panel door.
- Tank tray filters made of AISI-304 stainless steel, easy to access and remove for cleaning and access to the tank.
- Safety filter for pump suction.
- Rinsing boiler with heat insulation.
- Easy access for installation. Electrovalve located on one side (no need to remove panels to connect the machine).
- Electrical panel designed for easy connection of dosers for liquid and solid detergents, rinse aid, limit switches, supplementary emergency stop button.
- Washing arms easily removable as a set, for cleaning, with a plug on each branch providing access for cleaning inside.
- Rinse jets easily dismantlable and

- removable.
- System of electronic regulation of speeds by means of frequency shifter.
- Configurable electronic temperature control:
- Wash (50 - 65 °C)
- Rinse (70 - 85 °C)
- Guarantor of rinse at 85 °C.
- Pressure regulator for flow control.
- Emergency stop button incorporated.
- Extra anti-entrapment protection system at the entrance, mounted on the AS-260 splash guard supplement (optional).
- Open door blocking system.
- IPX4 protection system.
- System for detection of blockage of conveyor carriage and automatic reverse function.
- High-power washing system with 4 upper and 4 lower washing branches.
- 3 washing programs: deep, medium and high-capacity.

- Double effect rinse.
- Energy-saving system: reduces consumption by halting operation of the pumps, and by passing the heating of the rinse to stand-by mode (70 °C).
- Auto-timer which deactivates the conveyor motor after a pre-set period of inactivity (10 minutes).
- Energy saving system in the wash: the wash does not start up until it detects the passage of the basket.
- Rinse saving system. The rinse stops when the basket has left, saving water and energy.
- Limit switch included.

Equipment included:

- 2 base baskets, CT-10
- 2 baskets for plates CP-16/18, 1 basket for glasses CV-16/105, 1 basket for cutlery CT-10 R

MODEL	HZ.	CODE	ENTRANCE (*)	WATER SUPPLY	PROGRAMS (BASKETS/H)			INTERNAL ZONES (**)	WATER CONSUMPTION (L/H)	ELECTRICAL POWER (kW)	DIMENSIONS (mm)	€
					DEEP	MEDIUM	HIGH-CAPACITY					
CCO-160-L- HW	50	19048233	L	>50°	100	130	160		240	22.45	1,180 x 790 x 1,550	-
	60	19048576										
CCO-160-R- HW	50	19048255	R	>50°	100	130	160		240	22.45	1,180 x 790 x 1,550	-
	60	19048579										
CCO-160-L- CW	50	19048231	L	<50°	100	130	160		240	31.45	1,180 x 790 x 1,550	-
	60	19048575										
CCO-160-R- CW	50	19048254	R	<50°	100	130	160		240	31.45	1,180 x 790 x 1,550	-
	60	19048578										

(*) Entry of baskets:
L: Entrance from the Left of the machine.
R: Entrance from the Right of the machine.

(**)

Internal zones
LP: Main wash.
A: Double effect rinse.
A-ECO: Double ECO effect rinse.

Concept | Compact dishwasher “eco” version - gas heated



COMPACT DISHWASHER CCO-160-I-ECO WITH ANTI-SPLASH GUARD AS-260

General characteristics

- The ECO version conveyor dishwashers are fitted with an external hot water generator, gas heated, model GWB-40 (*).
- The generator replaces the electric rinse boiler in the dishwasher, bringing a significant saving in electricity consumption.
- Given the heating power of the generator, the dishwasher can be installed in facilities with a cold water connection.
- The dishwasher has a motor pump to send the water from the generator to the rinse jets.
- The dishwasher incorporates a flow regulator to ensure constant water consumption.
- The first filling of the dishwasher wash tank takes place with water from the generator, rapidly reaching the set temperature.

	MODEL	HZ.	CODE (#)	ENTRANCE (*)	WATER SUPPLY	PROGRAMS (BASKETS/H)			INTERNAL ZONES (**)	WATER CONSUMPTION (L/H)	ELECTRICAL POWER (kW)	GAS POWER (kW)	DIMENSIONS (mm)	€
						DEEP	MEDIUM	HIGH-CAPACITY						
	CCO-120-L-ECO	50	19046991	L	<50°	80	100	120		210	10.7	48	1,180 x 790 x 1,550	-
			19048572											
	CCO-120-R-ECO	50	19046990	R	<50°	80	100	120		210	10.7	48	1,180 x 790 x 1,550	-
			19048574											
	CCO-160-L-ECO	50	19048253	L	<50°	100	130	160		240	10.7	48	1,180 x 790 x 1,550	-
			19048577											
	CCO-160-R-ECO	50	19048256	R	<50°	100	130	160		240	10.7	48	1,180 x 790 x 1,550	-
			19048580											

(#) Note on codes

When placing your order, to the machine code, please add the generator code GWB-40, according to the type of gas and electrical frequency (see table on the following page), included in the price.

(*) Entry of baskets:

L: Entrance from the Left of the machine.
R: Entrance from the Right of the machine.

(**) Internal zones

LP: Main wash.
 A-ECO: Double effect rinse.

Complementary modules for compact conveyor dishwashers

Options in-factory assembly on demand

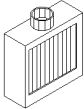
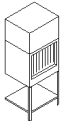
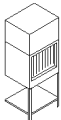
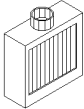
MODEL	CODE	DESCRIPTION	POWER (KW)	DIMENSIONS (mm)	€
 AS-260	19048568	ANTI-SPLASH GUARD SUPPLEMENT (ENTER) With fitting for connection of fume extractor. With separator curtains. Includes extra anti-entrapment protection element. Fitted as standard at the entrance of modular dishwashers.	-	L = 260 mm	-
 CDT-600	19046516	DRYING TUNNEL Supplementary element with 9 kW heating element box and upper fan for drying of the dishes with 0.55 kW motor. Module with conveyance system included, for placement at the end of the machine. With separator curtains. Bottom shelf.	9,55	600x790x1.930	-
 CRS-600	19048639	CONVEYOR RECOVERY SYSTEM Recommended for models with cold water input (CW) Aspires the steam generated inside the tunnel and sends the condensed water to the tank of the machine, increasing the water temperature from 15/18 °C to 35/40 °C. Allows savings of up to 3 kW-h. Recommended for models with cold water input (CW) with temperatures no higher than 25 °C. It is not appropriate for installation in machines with hot water input, nor in ECO models with rinse water heating in the GWB-40 generator. Module with conveyance system included. With separator curtains. Bottom shelf.	0,75	600x790x1.930	-
 ASE-260	19076633	ANTI-SPLASH GUARD SUPPLEMENT (EXIT) With fitting for connection of fume extractor. With separator curtains. Includes extra anti-entrapment protection element. Can also be fitted at the end of the tunnel.	-	L = 260 mm	-

Transformations to other voltages

VOLTAGE	CHARACTERISTICS	€
Supplement for MARINE version	Connection for ships (440 V - 60 Hz)	-
Supplement for 230 V 3 ~ version	230 V 3 ~	-

Rack conveyor | Modular dishwashers



General Characteristics

- All the main parts are manufactured in AISI-304 anti-corrosion stainless steel: tanks, washing and rinsing arms, rinsing jets, doors, basket conveyance system, boiler and metal tubes.
- Upwards-opening double panel door.
- Tank tray filters made of AISI-304 stainless steel, easy to access and remove for cleaning and access to the tank.
- Safety filter for pump suction.
- Rinsing boiler with heat insulation.
- Easy access for installation. Electrovalve located on one side (no need to remove panels to connect the machine).
- Electrical panel designed for easy connection of dosers for liquid and solid detergents, rinse aid, limit switches, supplementary emergency stop button.
- Washing arms easily removable as a set, for cleaning, with a plug on each branch providing access for cleaning inside.
- Rinse jets easily dismountable and removable.
- System of electronic regulation of speeds by means of frequency shifter.
- Configurable electronic temperature control:
 - Wash (50 - 65 °C)
 - Rinse (70 - 85 °C)
 - Guarantor of rinse at 85 °C.
 - Pressure regulator for flow control.
 - Emergency stop button incorporated.
 - Extra anti-entrapment protection system at the entrance, mounted on the AS-260 splash guard supplement, as standard.
 - Open door blocking system.
 - IPX4 protection system.
 - System for detection of blockage of conveyor carriage and automatic reverse function.
 - Prewash module with 3 upper and 3 lower washing branches.
 - High-power washing system with 5 upper and 5 lower washing branches.
 - 3 washing programs: intensive (DIN10534), medium and high-capacity.
 - Rinse and pre-rinse, both double effect, in models 180, 225 and 270.
- Double-effect rinse and triple-effect pre-rinse in model 320.
- Energy-saving system: reduces consumption by halting operation of the pumps, and by passing the heating of the rinse to stand-by mode (70 °C).
- Auto-timer which deactivates the conveyor motor after a pre-set period of inactivity (10 minutes).
- Energy saving system in the wash: the wash does not start up until it detects the passage of the basket.
- Rinse saving system. The rinse stops which the basket has left, saving water and energy.
- Limit switch included.

Equipment included:
 2 base baskets, CT-10
 2 baskets for plates CP-16/18, 1 basket for glasses CV-16/105, 1 basket for cutlery CT-10 R

MODEL	HZ.	CODE	ENTRANCE	PROGRAMS (BASKETS/H)			MODULES CONSUMPTION (**)	WATER CONSUMPTION (L/H)	ELECTRICAL POWER (KW)	DIMENSIONS (mm)	€
				(*) SUPPLY	INTENSIF	MEDIUM					
CCO-180-L-HW	50	19048582	L	>50°	90	135	180	210	25.7	1,750 x 790 x 1,550	-
	60	19048583									
CCO-180-R-HW	50	19048587	R	>50°	90	135	180	210	25.7	1,750 x 790 x 1,550	-
	60	19048588									
CCO-180-L-CW	50	19047209	L	<50°	90	135	180	210	34.7	1,750 x 790 x 1,550	-
	60	19048581									
CCO-180-R-CW	50	19047164	R	<50°	90	135	180	210	34.7	1,750 x 790 x 1,550	-
	60	19051473									
CCO-225-L-HW	50	19048595	L	>50°	125	175	225	210	35.9	2,360 x 790 x 1,550	-
	60	19048596									
CCO-225-R-HW	50	19048212	R	>50°	125	175	225	210	35.9	2,360 x 790 x 1,550	-
	60	19048600									
CCO-225-L-CW	50	19048119	L	<50°	125	175	225	210	44.9	2,360 x 790 x 1,550	-
	60	19048594									
CCO-225-R-CW	50	19048120	R	<50°	125	175	225	210	44.9	2,360 x 790 x 1,550	-
	60	19048599									

(*) Entry of baskets:

L: Entrance from the Left of the machine.
 R: Entrance from the Right of the machine.

(**) COMPOSITION OF MODULES

The diagrams and composition indicated always refer to the left-entry version.

- AS-260: Anti-splash guard supplement
- PL3: Cold water prewash
- PL5: First Wash with cold water
- L5: First wash with hot water
- LP: Main wash
- DA: Double-effect rinse and pre-rinse
- TA: Double-effect rinse and triple-effect pre-rinse



Rack conveyor | Modular dishwashers



General Characteristics





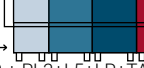
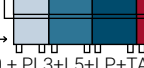

- All the main parts are manufactured in AISI-304 anti-corrosion stainless steel: tanks, washing and rinsing arms, rinsing jets, doors, basket conveyance system, boiler and metal tubes.
- Upwards-opening double panel door.
- Tank tray filters made of AISI-304 stainless steel, easy to access and remove for cleaning and access to the tank.
- Safety filter for pump suction.
- Rinsing boiler with heat insulation.
- Easy access for installation. Electrovalve located on one side (no need to remove panels to connect the machine).
- Electrical panel designed for easy connection of dosers for liquid and solid detergents, rinse aid, limit switches, supplementary emergency stop button.
- Washing arms easily removable as a set, for cleaning, with a plug on each branch providing access for cleaning inside.
- Rinse jets easily dismantlable and removable.
- System of electronic regulation of speeds by means of frequency shifter.
- Configurable electronic temperature control:
 - Wash (50 - 65 °C)
 - Rinse (70 - 85 °C)
 - Guarantor of rinse at 85 °C.
- Pressure regulator for flow control.
- Emergency stop button incorporated.
- Extra anti-entrapment protection system at the entrance, mounted on the AS-260 splash guard supplement, as standard.
- Open door blocking system.
- IPX4 protection system.
- System for detection of blockage of conveyor carriage and automatic reverse function.
- Prewash module with 3 upper and 3 lower washing branches.
- High-power washing system with 5 upper and 5 lower washing branches.
- 3 washing programs: intensive (DIN10534), medium and high-capacity.
- Rinse and pre-rinse, both double effect, in models 180, 225 and 270.
- Double-effect rinse and triple-effect pre-rinse in model 320.
- Energy-saving system: reduces consumption by halting operation of the pumps, and by passing the heating of the rinse to stand-by mode (70 °C).
- Auto-timer which deactivates the conveyor motor after a pre-set period of inactivity (10 minutes).
- Energy saving system in the wash: the wash does not start up until it detects the passage of the basket.
- Rinse saving system. The rinse stops when the basket has left, saving water and energy.
- Limit switch included.

Equipment included:
 2 base baskets, CT-10
 2 baskets for plates CP-16/18, 1 basket for glasses CV-16/105, 1 basket for cutlery CT-10 R

MODEL	HZ.	CODE	ENTRANCE	WATER SUPPLY (*)	PROGRAMS (BASKETS/H)			MODULES CONSUMPTION (**)	WATER CONSUMPTION (L/H)	ELECTRICAL POWER (KW)	DIMENSIONS (mm)	€
					INTENSIF	MEDIUM	HIGH-CAPACITY					
CCO-270-L-HW	50	19048608	L	>50°	140	205	270	 AS-260 + PL5+LP+DA	240	39,9	2,660 x 790 x 1,550	-
CCO-270-R-HW	60	19048614										
CCO-270-L-CW	50	19048606	L	<50°	140	205	270	 AS-260 + PL5+LP+DA	240	48,9	2,660 x 790 x 1,550	-
CCO-270-R-CW	60	19048613										
CCO-320-L-HW	50	19048621	L	>50°	170	245	320	 AS-260 + PL3+L5+LP+TA	240	47.1	3,260 x 790 x 1,550	-
CCO-320-R-HW	60	19048631										
CCO-320-L-CW	50	19048618	L	<50°	170	245	320	 AS-260 + PL3+L5+LP+TA	240	56.1	3,260 x 790 x 1,550	-
CCO-320-R-CW	60	19048628										

(*) Entry of baskets:
 L: Entrance from the Left of the machine.
 R: Entrance from the Right of the machine.

(**) COMPOSITION OF MODULES
 The diagrams and composition indicated always refer to the left-entry version.

-  AS-260: Anti-splash guard supplement
-  PL3: Cold water prewash
-  PL5: First Wash with cold water
-  L5: First wash with hot water
-  LP: Main wash
-  DA: Double-effect rinse and pre-rinse
-  TA: Double-effect rinse and triple-effect pre-rinse

Concept modular | Dishwashers “ECO” version - gas heated



Specific characteristics

- The ECO version conveyor dishwashers are fitted with an external hot water generator, gas heated, model GWB-40 (*).
- The generator replaces the electric rinse boiler in the dishwasher, bringing a significant saving in electricity consumption.
- Given the heating power of the generator, the dishwasher is for installation in facilities with a cold water connection.
- The dishwasher has a motor pump to send the water from the generator to the rinse jets.
- The dishwasher incorporates a flow regulator to ensure constant water consumption.
- The first filling of the dishwasher wash tank takes place with water both from the generator and from the filling electrovalve.

MODEL	HZ.	CODE	ENTRANCE WATER	PROGRAMS (BASKETS/H)			MODULES CONSUMPTION (#)	WATER CONSUMPTION (L/H)	ELECTRICAL POWER (KW)	GAS POWER (KW)	DIMENSIONS (mm)	€
				RED	INTENSIF	MEDIUM						
CCO-180-L-ECO	50	19048584	L	<50°	90	135	180	210	19,7	48	1.750 x 790 x 1.550	-
	60	19048586										
CCO-180-R-ECO	50	19048591	R	<50°	90	135	180	210	19,7	48	1.750 x 790 x 1.550	-
	60	19048593										
CCO-225-L-ECO	50	19048597	L	<50°	125	175	225	210	20,9	48	2.360 x 790 x 1.550	-
	60	19048598										
CCO-225-R-ECO	50	19048602	R	<50°	125	175	225	210	20,9	48	2.360 x 790 x 1.550	-
	60	19048603										
CCO-270-L-ECO	50	19048610	L	<50°	140	205	270	240	21,9	48	2.660 x 790 x 1.550	-
	60	19048611										
CCO-270-R-ECO	50	19048616	R	<50°	140	205	270	240	21,9	48	2.660 x 790 x 1.550	-
	60	19048617										
CCO-320-L-ECO	50	19048624	L	<50°	170	245	320	240	29,1	48	3.260 x 790 x 1.550	-
	60	19048626										
CCO-320-R-ECO	50	19048633	R	<50°	170	245	320	240	29,1	48	3.260 x 790 x 1.550	-
	60	19048636										

(#) Note on codes
When placing your order, to the machine code, please add the generator code GWB-40, according to the type of gas and electrical frequency (see table on the following page), included in the price.



(*) Entry of baskets:
L: Entrance from the Left of the machine.
R: Entrance from the Right of the machine.

(**) COMPOSITION OF MODULES
The diagrams and composition indicated always refer to the left-entry version.

- AS-260: Anti-splash guard supplement
- PL3: Cold water prewash
- PL5: First Wash with cold water
- L5: First wash with hot water
- LP: Main wash
- DA: Double-effect rinse and pre-rinse
- TA: Double-effect rinse and triple-effect pre-rinse

Complementary modules for modular conveyor dishwashers

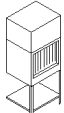
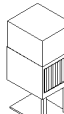
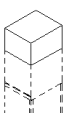
Options in-factory assembly on demand

MODEL	CODE	DESCRIPTION	POWER (kW)	DIMENSIONS (mm)	€	
	CDT-600	19046516	DRYING TUNNEL Specially for modular models 180 and 225. Supplementary element with 9 kW heating element box and upper fan for drying of the dishes with 0.55 kW motor. Module with conveyance system included, for placement at the end of the machine. With separator curtains. Bottom shelf.	9,55	600x790x1.930	-
	CDT-800	19047215	EXTRA DRYING TUNNEL Specially for modular models 270 and 320. Supplementary element with 13.5 kW heating element box and upper fan for drying of the dishes with 1.1 kW motor. Module with conveyance system included, for placement at the end of the machine. With separator curtains. Bottom shelf.	14,6	800x790x1.930	-
	(#) CRS-700-I CRS-700-D	19056031 19048641	UPPER ENERGY RECYCLER Recommended for models with cold water input (CW). Aspires the steam generated inside the tunnel and sends the condensed water to the tank of the machine, increasing the water temperature from 15/18 °C to 35/40 °C. Allows savings of up to 3 kW-h. Fitted into the top of the dishwasher. Does not increase length. Recommended for models with cold water input (CW) with temperatures no higher than 25 °C. It is not appropriate for installation in machines with hot water input, nor in ECO models with rinse water heating in the GWB-40 generator.	0,55	600x790x500	-
	ASE-260	19076633	ANTI-SPLASH GUARD SUPPLEMENT (EXIT) With fitting for connection of fume extractor. With separator curtains. Includes extra anti-entrapment protection element. Fitted as standard at the entrance of modular dishwashers. Can also be fitted at the end of the tunnel.	-	L = 260 mm	-

(*) Entry of baskets:
L: Entrance from the Left of the machine.
R: Entrance from the Right of the machine.

Transformations to other voltages

VOLTAGE	CHARACTERISTICS	€
Supplement for MARINE version	Connection for ships (440 V - 60 Hz)	-
Supplement for 230 V 3 ~ version	230 V 3 ~	-



Summary of characteristics of the different modules

Table of modules which can form part of the composition of the modular conveyance trains.

The composition of the different models is indicated on the previous pages.

MODULE		CCO-120	CCO-160	CCO-180	CCO-225	CCO-270	CCO-320
Supplementary Anti-splash + anti-entrapment protection at the entrance	AS-260	•	•	•	•	•	•
Prewash	PL3	-	-	-	•	-	•
Intense prewash	PL5	-	-	-	-	•	-
First wash	L5	-	-	-	-	-	•
Main wash	LP	•	•	•	•	•	•
Double effect rinse	A	•	•	-	-	-	-
Double effect ECO rinse	A-ECO	•	•	-	-	-	-
Double effect pre-rinse + Double effect rinse	DA	-	-	•	•	•	-
Double effect pre-rinse + Double effect ECO rinse	DA-ECO	-	-	•	•	•	-
Triple effect pre-rinse + Double effect rinse	TA	-	-	-	-	-	•
Triple effect pre-rinse + Double effect ECO rinse	DA / TA-ECO	-	-	-	-	-	•
Drying Module 600	CDT-600	•	•	•	•	-	-
Drying Module 800	CDT-800	-	-	-	-	•	•
Energy recycler for compact models	CRS-600	•	•	-	-	-	-
Energy recycler for modular dishwashers	CRS-700	-	-	•	•	•	•
Supplementary anti-splash guard at the exit	AS-260	•	•	•	•	•	•

All the modular machines come with an anti-splash module AS-260 at the entrance as standard, 260 mm in length.
An exterior extractor can be fitted to this module.
Optionally, you can also request it as a supplement to fit to the exit of the machine.
The CDT drying tunnels are fitted to the exit of the machine, increasing the total length by 600 or 800 mm (depending on the model of drying tunnel installed). For models 270 and 320, the extra CDT-800 drying tunnel is to be installed.

The CRS-700 energy recycler is to be placed on top of the modular dishwashers, and the total length is not increased. Recommended for models with cold water input (CW) with temperatures no higher than 25 °C. It is not appropriate for installation in machines with hot water input, nor in ECO models with rinse water heating in the GWB-40 generator.
The mission of this accessory is to collect the steam from the inside of the dishwasher, and, after a process of condensation, send this water (which is at high temperature) to the rinse system. This raises the average temperature in the rinse system, which therefore requires a lower supply of electrical energy, contributing to notable savings in energy and costs (around 3 kW-h).



Summary table of characteristics for conveyor dishwashers

	CCO-120	CCO-160	CCO-180	CCO-225	CCO-270	CCO-320
SPEEDS	3	3	3	3	3	3
PRODUCTION (baskets/h)						
Deep wash program	80	100	-	-	-	-
Intensive program (DIN-10534)	-	-	90	125	140	170
Medium program	100	130	135	175	225	245
High-capacity program	120	160	180	225	270	320
PREWASH PL3,PL5						
Tank capacity (l)	-	-	-	60	100	60
Pump power (kW)	-	-	-	1,2	2,2	1,2
WASH L5, LP						
Tank capacity (l)	50	50	100	100	100	200
Temperature (°C)	55-65	55-65	55-65	55-65	55-65	55-65
Heating power (kW)	9	9	12	12	12	18
Pump power (kW)	1.2	1.2	2.2	2.2	2,2	4.4
PRE-RINSE DA, TA						
Tank capacity (l)	-	-	15	15	15	15
Temperature (°C)	-	-	70	70	70	70
Heating power (kW)	-	-	5	5	5	5
Pump power (kW)	-	-	0.26	0.26	0.26	0.26
RINSE						
Boiler volume (l)	21	21	21	21	21	21
Temperature (°C)	80-85	80-85	80-85	80-85	80-85	80-85
Heating power (kW)						
CW	27	30	27	24	27	27
CW with recycler	24	27	24	21	24	24
HW	18	21	18	15	18	18
ECO	-	-	-	-	-	-
ECO rinse pump power (kW)	0,26	0,26	0,26	0,26	0,26	0,26
Water consumption 1						
(l/h)	210	240	210	210	240	240
(l/basket)	1.75	1.5	1.17	0.93	0.89	0.75
STANDARD CONNECTION						
Type of connection (default)	ALT.	ALT.	ALT.	SIM.	SIM.	SIM.
Voltage 2	400 V /3N ~ / 50 - 60Hz					
TOTAL POWER (kW)						
CW	28.5	31.5	34.7	44.9	48.9	56.1
CW with recycler	26.2	29.2	32.3	42.5	46.5	53.7
HW	19.5	22.5	25.7	35.9	39.9	47.1
ECO	10.7	10.7	19.7	20.9	21.9	29.1
ECO gas booster (gas kW)	38	38	38	38	38	38
WIDTH (mm)	1180	1180	1750	2360	2660	3260
Standard	1180	1180	1500	2100	2400	3000
With entrance module	1440	1440	1760	2360	2660	3260
With drying module	1780	1780	2100	2700	3200	3800
DEPTH (mm)	790	790	790	790	790	790
HEIGHT (mm) 3	1550	1550	1550	1550	1550	1550
Standard	1550-1610	1550-1610	1550-1610	1550-1610	1550-1610	1550-1610
With drying	1860-1920	1860-1920	1860-1920	1860-1920	1860-1920	1860-1920
With recycler	1960-2020	1960-2020	1960-2020	1960-2020	1960-2020	1960-2020
With open door blocking system	1870-1930	1870-1930	1870-1930	1870-1930	1870-1930	1870-1930
OPERATING HEIGHT (mm)	850-900	850-900	850-900	850-900	850-900	850-900
USEFUL ENTRANCE HEIGHT (mm)	390	390	390	390	390	390
PASSAGE WIDTH (mm)	510	510	510	510	510	510
WEIGHT (KG)						
Net	211	211	259	381	434	556
Gross	305	305	382	556	628	792
WATER CONNECTION						
Operating pressure	2 - 4 bars					
Type of connection	3/4" GAS					
T ^a of hot water	50 °C - 60 °C					
T ^a of cold water	15 °C - 50 °C					

1- Non-binding information Consumption might vary depending on the characteristics of the facility
 2- Standard voltage: 400 V 3+N - For other voltages and options, please consult Fagor Industrial
 3- The adjustable feet allow for height adjustment, raising the machine by up to 60 mm

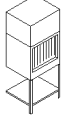
Kits and accessories for manufactured machines

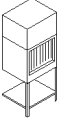
MODEL	CODE	DESCRIPTION	POWER (KW)	DIMENSIONS (mm)	€
 CDT-600	19056095	DRYING TUNNEL Supplementary element with 9 kW heating element box and upper fan for drying of the dishes with 0.55 kW motor. Module with conveyance system included, for placement at the end of the machine. With separator curtains. Bottom shelf.	9,55	600x790x1.930	-

MODEL	CODE	DESCRIPTION	POWER (KW)	DIMENSIONS (mm)	€
 CDT-600	19056095	DRYING TUNNEL Specially for modular models 180 and 225. Supplementary element with 9 kW heating element box and upper fan for drying of the dishes with 0.55 kW motor. Module with conveyance system included, for placement at the end of the machine. With separator curtains. Bottom shelf.	9,55	600x790x1.930	-
 CDT-800	19056098	EXTRA DRYING TUNNEL Specially for modular models 270 and 320. Supplementary element with 13.5 kW heating element box and upper fan for drying of the dishes with 1.1 kW motor. Module with conveyance system included, for placement at the end of the machine. With separator curtains. Bottom shelf.	14,6	800x790x1.930	-

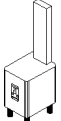







MODEL	CODE	DESCRIPTION	POWER (KW)	DIMENSIONS (mm)	€
 GWB-40	LPG 50 Hz - 19011596 LPG 60 Hz - 19044808 GN 50 Hz - 19038585 GN 60 Hz - 19044809	GAS HOT WATER GENERATOR Forced draught burner and double safety valve. Electronic control of temperature and water levels. Automatic limescale removal. Automatic tank emptying.	40,00	432x548x770	-

Pre washing tables



General characteristics

- Manufactured for the compact and modular conveyor dishwashers.

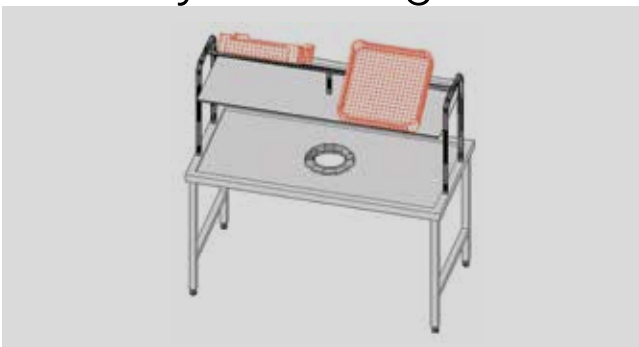

MODEL	CODE	SITUATION OF THE TABLE	EQUIPMENT FEATURES	DIMENSIONS (mm)	€
 MLB-1200 LM-D	19006097	R	- Rear guard - Lower rack - Guides for baskets	1.200x800x900	-
 MLB-1200 LM-I	19006096	L			
 MLB-1200 ECO/LM-D	19006099	R	- Rear guard - Lower rack - Guides for baskets	1.200x800x900	-
 MLB-1200 ECO/LM-I	19006098	L	- Hole for chimney		
 MFDB-1200 LM-D	19006104	R	- Rear guard - Sink - Shower tap - Lower rack - Guides for baskets	1.200x800x900	-
 MFDB-1200 LM-I	19006105	L			
 MFDB-1500 LM-D	19006404	R	- Rear guard - Sink - Shower tap - Lower rack - Guides for baskets	1.500x800x900	-
 MFDB-1500 LM-I	19006405	L			

Delivery / sorting tables



General characteristics

- Serving staff can deposit dirty dishes while the dishwashing staff are sorting them on the other side.
- The table is supplied with a sorting shelf (450 mm over the work top) and a waste disposal.
- Adjustable feet.

MODEL	CODE	SHELF DIMENSIONS (mm)	SHELF CAPACITY (BASKETS)	DIMENSIONS (mm)	€
 MD3C	19006410	1.530x600	3	1.600x800x1.450	-
 MD4C	19006509	2.030x600	4	2.100x800x1.450	-

Delivery / sorting tables



MFDH-1800 LM-I, model, with sink, shower tap, waste disposal, rear guard and guides for baskets

General characteristics

- Manufactured for the compact and modular conveyor dishwashers:

- Rear guard in all the models.
- Waste disposal.

- Space for the trash bin.
- Tables with sink built-in shower tap.

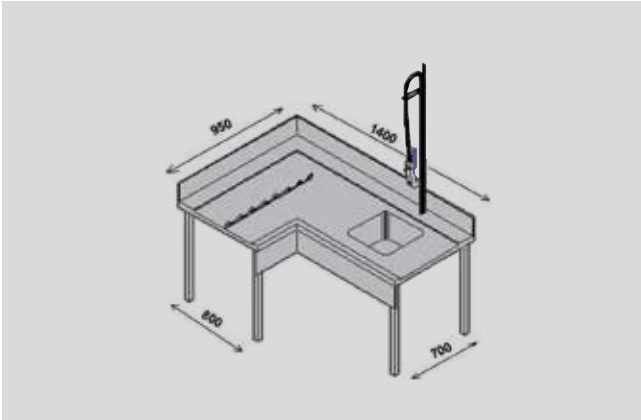

MODEL	CODE	SITUATION OF THE TABLE	HOUSING FOR BIN	CHARACTERISTICS	DIMENSIONS (mm)	€
 MLH-1200 LM-D	19006100	R	OPEN	- Lower rack	1.200x800x900	-
 MLH-1200 LM-I	19006101	L				
 MLP-1200 LM-D	19006102	R	DOOR	- Lower rack	1.200x800x900	-
 MLP-1200 LM-I	19006103	L				
 MFDH-1200 LM-D	19006106	R	OPEN	- Sink - Shower tap - Lower rack	1.200x800x900	-
 MFDH-1200 LM-I	19006107	L				
 MFDP-1200 LM-D	19006108	R	DOOR	- Sink - Shower tap - Lower rack	1.200x800x900	-
 MFDP-1200 LM-I	19006109	L				
 MFDH-1500 LM-D	19006408	R	OPEN	- Sink - Shower tap - Lower rack	1.500x800x900	-
 MFDH-1500 LM-I	19006407	L				
 MFDP-1500 LM-D	19006409	R	DOOR	- Sink - Shower tap - Lower rack	1.500x800x900	-
 MFDP-1500 LM-I	19006406	L				
 MFDH-1800 LM-D	19006506	R	OPEN	- Sink - Shower tap - Lower rack - Guides for baskets	1.800x800x900	-
 MFDH-1800 LM-I	19006507	L				
 MFDP-1800 LM-D	19006508	R	DOOR	- Sink - Shower tap - Lower rack - Guides for baskets	1.800x800x900	-
 MFDP-1800 LM-I	19006505	L				

Prewashing table with introducer of baskets in corner



General characteristics

- Rear guard 200 mm. Built in sink and shower tap.
- Length of the sink side: 1,400 mm - Depth: 700 mm.
- Element to introduce the baskets with the movement of the advancement system of the conveyor.
- Length of the introducer side: 950 mm - Depth: 800 mm.





MODEL	CODE	SITUATION OF THE TABLE	EQUIPMENT FEATURES	DIMENSIONS (mm)	€
 MCFD-1000 D	19006350	R	- Rear guard - Sink - Shower tap - Introducer	1.400x950x900	-
 MCFD-1000 I	19006351	L			

Introducers of baskets in corner



General characteristics

- Element to introduce the baskets in the machine.
- Movement by the advancement system of the conveyor.
- Lower shelf.

MODEL	CODE	DESCRIPTION	DIMENSIONS (mm)	€
 E-90-I	19004789	INTRODUCER OF BASKETS BY THE LEFT SIDE For conveyors WITH neutral element at the entry.	800x700x850 (+250)	-
 E-90-I-CV	19004792	INTRODUCER OF BASKETS BY THE LEFT SIDE For conveyors WITHOUT neutral element at the entry. For conveyors WITH STEAM CONDENSER at the entry.	800x700x850 (+250)	-
 E-90-D	19004790	INTRODUCER OF BASKETS BY THE RIGHT SIDE For conveyors WITH neutral element at the entry.	800x700x850 (+250)	-
 E-90-D-CV	19004791	INTRODUCER OF BASKETS BY THE RIGHT SIDE For conveyors WITHOUT neutral element at the entry. For conveyors WITH STEAM CONDENSER at the entry.	800x700x850 (+250)	-

Automatized curves



General characteristics

- Automatic movement with the conveyor exit system.

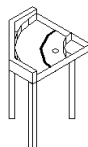
MODEL	CODE	INSTALLATION EXIT	DESCRIPTION	DIMENSIONS (mm)	€
	180-I-TS	19004788	L AUTOMATIZED CURVE 180° AT LEFT For models without neutral supplement on the exit. For models WITH DRYING TUNNEL, also.	778x1.442x900	-
	180-I	19004786	L AUTOMATIZED CURVE 180° AT LEFT For models with neutral supplement on the exit.	778x1.442x900	-
	180-D-TS	19004797	R AUTOMATIZED CURVE 180° AT RIGHT For models without neutral supplement on the exit. For models WITH DRYING TUNNEL, also.	778x1.442x900	-
	180-D	19004787	R AUTOMATIZED CURVE 180° AT RIGHT For models with neutral supplement on the exit.	778x1.442x900	-
	90-I-TS	19004795	L AUTOMATIZED CURVE 90° AT LEFT For models without neutral supplement on the exit. For models WITH DRYING TUNNEL, also.	778x778x900	-
	90-I	19004794	L AUTOMATIZED CURVE 90° AT LEFT For models with neutral supplement on the exit.	778x778x900	-
	90-D-TS	19004796	R AUTOMATIZED CURVE 90° AT RIGHT For models without neutral supplement on the exit. For models WITH DRYING TUNNEL, also.	778x778x900	-
	90-D	19004793	R AUTOMATIZED CURVE 90° AT RIGHT For models with neutral supplement on the exit.	778x778x900	-

Rolling tables



General characteristics

- Removable rolling units made in ABS, Ø 40 mm.
- Easy cleaning.
- Drain outlet.
- Adjustable stainless steel legs.
- Can be connected to the automatic curves.

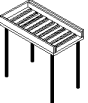
MODEL	CODE	DESCRIPTION	CAPACITY (BASKETS)	DIMENSIONS (mm)	€	
	MR2C	19004901	Rolling table	2	1.150x630x870	-
	MR3C	19005073	Rolling table	3	1.660x630x870	-
	MR4C	19004902	Rolling table	4	2.170x630x870	-





A high performance solution.



Find out more!



Access the website



Comercial video



Sales brochure

Flight type dishwashers

Flight type dishwashers	401
Available belts	403
Accessories	405

Water connection:
It is advisable to introduce sanitary water in the dishwashers, with a temperature of 50 - 60 °C.

Water pressure:
Minimum: 2 bar = 2 kg/cm²
Maximum: 4 bar = 4 kg/cm²

Water softener:
All glass / dishwashers should be connected to a treated water supply when the local supply is over 10 HF / 6 HD.

Any issues derived from a bad installation that don't meet with the indicated conditions will not be considered as a warranty.

Electric flight dishwashers



BELTS AVAILABLE:

The machine must be ordered with one of these three types of belts:





- For plates and dish baskets
- For kitchenware (pots, containers and trays)
- For isothermal trays

The order must also include the dishwasher machine code and the belt code (on the following pages).

The machine price does not include the belt









General characteristics

- Manufactured in stainless steel. Double wall.
- Machines made of different modules according to models and needs.
- Entry tunnel 630 x 440 mm.
- Splash-guard modules at entry DE SERIES.
- Loading section (1.2 m) and unloading section (2.2 m), 900 mm high, with standard 600 mm-wide belt for dishes and trays.
- High-power, standard drier with possibility of adding up to 2 EXTRA standard driers.
- Adaptive final-rinse system with rinse pump with break tank that ensures low, consistent use, adapts to all speeds.
- Break tank for water inlet in the boiler at a constant pressure. Inlet solenoid valve with filter for break tank.
- Double-effect rinse module with pre-rinse tank and water boiler.
- Automatic detection of dishes using photocell sensor.
- Steam extraction system to prevent steam from leaving. Adjustable.
- Automatic water-renewal system for prewash. ONLY IN MODULES ABOVE FCO-W4.
- Double curtains at the entry and exit, and Foodservice | Dishwashing to divide the different inner areas.
- Stop/start switches at the entry and exit.
- Prewashing and washing arms made of stainless steel which can be detached for cleaning.
- Triple filtration in the washing modules.
- Embedded tank bottom to guarantee complete emptying and enable cleaning.
- Standard energy recovery system. Reduction of 9kWh.
- Double-effect rinse module with pre-rinse tank and boiler to heat water.
- Electronic temperature control of water for wash, prewash and rinse.
- Safety thermostat.
- 3 production programmes. It fulfils DIN 10534 standard (progr. 1)
- ANTI-BLOCK system with belt reversal.
- Detection of belt end with stop and auto-start.
- Doors with sensors to stop machine.
- Micro magnets for door opening and safety.
- 0.25 kW moto-reducer controlled by frequency converter.
- Stop/start switches at the entry and exit.
- Standard provision of baskets: 2 x CT-10, 2 x CV -16/105 and 1 basket for cutlery.

MODEL	HZ.	CODE	MAX. PRODUCTION (PLATOS/HORA)	ENTRY	MODULE COMPOSITION (°)	WATER (L/H)	ELECTRIC POWER (KW)	DIMMENSIONS (mm)	€
FCO-W4-RD R	50	19073687	3100	R	 W+4+RD	190-230	53,8	4988x900x2070	-
FCO-W4-RD L	50	19075203	3100	L	 W+4+RD	190-230	53,8	4988x900x2070	-
FCO-PW4-RD R	50	19068360	4600	R	 P+W+4+RD	190-230	53,4	5890x900x2070	-
FCO-PW4-RD L	50	19068366	4600	L	 P+W+4+RD	190-230	53,4	5890x900x2070	-

Circulation of baskets:
L: Entry through the left part of the machine.
R: Entry through the right part of the machine.

Standard voltage: 400V 3N~

- | | |
|--|---|
|  E Loading area |  4 Rinse: gradual rinse module with rinse pump |
|  A Splash guard |  4G Rinse: gradual rinse module with rinse pump and incorporated gas generator |
|  P Prewash: cold-water prewash module |  D Drying: high-power drier module |
|  W Wash: main wash module at 65°C |  R Energy recovery system |

Electric flight dishwashers

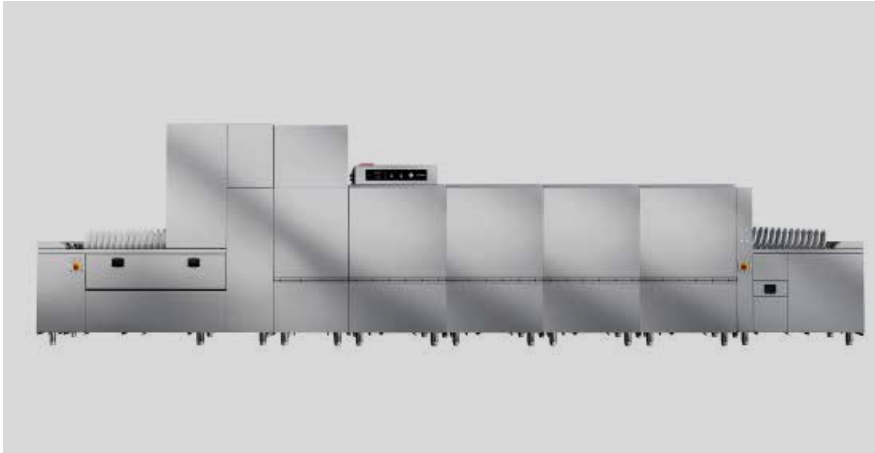

BELTS AVAILABLE:

The machine must be ordered with one of these three types of belts:

- For plates and dish baskets
- For kitchenware (pots, containers and trays)
- For isothermal trays

The order must also include the dishwasher machine code and the belt code (on the following pages).

The machine price does not include the belt

General characteristics

- Manufactured in stainless steel. Double wall.
- Machines made of different modules according to models and needs.
- Entry tunnel 630 x 440 mm.
- Splash-guard modules at entry DE SERIES.
- Loading section (1.2 m) and unloading section (2.2 m), 900 mm high, with standard 600 mm-wide belt for dishes and trays.
- High-power, standard drier with possibility of adding up to 2 EXTRA standard driers.
- Adaptive final-rinse system with rinse pump with break tank that ensures low, consistent use, adapts to all speeds.
- Break tank for water inlet in the boiler at a constant pressure. Inlet solenoid valve with filter for break tank.
- Double-effect rinse module with pre-rinse tank and water boiler.
- Automatic detection of dishes using photocell sensor.
- Steam extraction system to prevent steam from leaving. Adjustable.
- Automatic water-renewal system for prewash.
- Double curtains at the entry and exit, and Foodservice | Dishwashing to divide the different inner areas.
- Stop/start switches at the entry and exit.
- Prewashing and washing arms made of stainless steel which can be detached for cleaning.
- Triple filtration in the washing modules.
- Embedded tank bottom to guarantee complete emptying and enable cleaning.
- Standard energy recovery system. Reduction of 9kWh.
- Automatic pre-heating system.
- Triple-effect prewash system. Quadruple-effect prewash in FCO-P2W4 and FCO-P3W4 models.
- Double-effect rinse module with pre-rinse tank and boiler to heat water.
- Electronic temperature control of water for wash, prewash and rinse.
- Safety thermostat.
- 3 production programmes. It fulfils DIN 10534 standard (progr. 1)
- ANTI-BLOCK system with belt reversal.
- Detection of belt end with stop and auto-start.
- Doors with sensors to stop machine.
- Micro magnets for door opening and safety.
- 0.25 kW moto-reducer controlled by frequency converter.
- Stop/start switches at the entry and exit.
- Standard provision of baskets: 2 x CT-10, 2 x CV -16/105 and 1 basket for cutlery.

MODEL	HZ.	CODE	MAX. PRODUCTION (PLATOS/HORA)	ENTRY	MODULE COMPOSITION (*)	WATER (L/H)	ELECTRIC POWER (KW)	DIMMENSIONS (mm)	€
FCO-P2W4-RDR	50	19074752	6600	R	P+2W+4+RD	220-270	68	6792x900x2070	-
FCO-P2W4-RDL	50	19073649	6600	L	P+2W+4+RD	220-270	68	6792x900x2070	-
FCO-P3W4-RDR	50	19075204	8600	R	P+3W+4+RD	220-270	82,6	7692x900x2070	-
FCO-P3W4-RDL	50	19075119	8600	L	P+3W+4+RD	220-270	82,6	7692x900x2070	-

Circulation of baskets:
L: Entry through the left part of the machine.
R: Entry through the right part of the machine.

Standard voltage: 400V 3N~

- E Loading area
- A Splash guard
- P Prewash: cold-water prewash module
- W Wash: main wash module at 65°C
- 4 Rinse: gradual rinse module with rinse pump
- 4G Rinse: gradual rinse module with rinse pump and incorporated gas generator
- D Drying: high-power drier module
- R Energy recovery system

Available belts

Standard belt for dishes and baskets



CODE	DESCRIPTION	FOR MODELS		€
19072468	PLATE BELT FCO-W4-RD	FCO-W4-RD	FCO-W4G-RD	-
19074856	PLATE BELT FCO-PW4	FCO-PW4-RD	FCO-PW4G-RD	-
19073644	PLATE BELT FCO-P2W4	FCO-P2W4-RD	FCO-P2W4G-RD	-
19075208	PLATE BELT FCO-P3W4	FCO-P3W4-RD	FCO-P3W4G-RD	-

Specific belt for pots and containers



CODE	DESCRIPTION	FOR MODELS		€
19072498	KITCHENWARE BELT FCO-W4-RD	FCO-W4-RD	FCO-W4G-RD	-
19072700	KITCHENWARE BELT FCO-PW4-RD	FCO-PW4-RD	FCO-PW4G-RD	-
19072701	KITCHENWARE BELT FCO-P2W4-RD	FCO-P2W4-RD	FCO-P2W4G-RD	-
19072707	KITCHENWARE BELT FCO-P3W4-RD	FCO-P3W4-RD	FCO-P3W4G-RD	-

Specific belt for isothermal trays



CODE	DESCRIPTION	FOR MODELS		€
19072497	BELT FOR ISOTHERMAL TRAYS FCO-W4-RD	FCO-W4-RD	FCO-W4G-RD	-
19075209	BELT FOR ISOTHERMAL TRAYS FCO-PW4	FCO-PW4-RD	FCO-PW4G-RD	-
19075210	BELT FOR ISOTHERMAL TRAYS FCO-P2W4	FCO-P2W4-RD	FCO-P2W4G-RD	-
19075211	BELT FOR ISOTHERMAL TRAYS FCO-P3W4	FCO-P3W4-RD	FCO-P3W4G-RD	-

Modular elements and accessories for flight dishwashers



Modules for flight-type dishwashers (*)

MODELO	CÓDIGO	DESCRIPCIÓN	POWER (KW)	DIMMENSIONS (mm)	€
FDM-700	19075207	EXTRA DRIER	9.5 kw	700x900x2070	-
PRESSURE PUMP KIT	19004543	50 Hz - 230V 1N~	1 kw	-	-
PRESSURE PUMP KIT	19005676	60 Hz - 230V 1N~	1kw	-	-

Delivery of the machine in multiple packages

MODELO	CÓDIGO	DESCRIPCIÓN	€
BELT MODULES DISASSEMBLY KIT	19075212	Extra for the disassembly and delivery of the machine in several parts.	-

Modular sections for flight dishwashers (*)



MODULE	NAME	PUMPS (KW)	TANKS		BOILER (KW)	LARGE (mm)	POWER (KW)
			(L)	(KW)			
E	Loading area	-	-	-	-	1180	-
A	Splash guard	-	-	-	-	0	-
P	Prewash	1x2,6	100	-	-	900	2.6
W	Main wash	1x2,6	100	15 / 18 en el FCO-W4	-	900	14.6
2W	2 main washes	2x2,6	200	27	-	1800	32.2
3W	3 main washes	3x2,6	300	39	-	2700	46.8
4	Double rinse	0.26 + .15	30	5	18	700	18.41
4G	Double	0.26 + .15	30	5	-	700	0.41
S	Tunnel	-	-	-	-	0	9.5
R	Recovery system	-	-	-	-	0	0.90
S	Unloading area	-	-	-	-	2200	-

Table of modules that may form part of the flight-type dishwasher. The composition of the different modules is indicated on the previous pages.

(*) Notes on the additional modular elements:

All flight-type dishwashers are equipped, as standard, with a neutral, 150 mm anti-splash module at the entrance. This module is mounted on top of the loading table.

The drier tunnel is positioned at the exit of the machine. Its length is not increased since the tunnel is placed on top of the unloading table.

The energy recovery system is positioned on top of the dishwasher, and therefore the total length is not increased. This accessory collects steam from within the dishwasher and, after condensation, sends it to the entry of the boiler where, as an exchanger, it increases the temperature of the mains water, requiring less electricity and giving rise to notable energy and cost savings.





The best accessory
for our wide range of
dishwashers.



Find out more!



Access the website

Dishwasher accessories

Water treatment	409
Baskets	411

Water connection:
It is advisable to introduce sanitary water in the dishwashers, with a temperature of 50 - 60 °C.

Water pressure:
Minimum: 2 bar = 2 kg/cm²
Maximum: 4 bar = 4 kg/cm²

Water softener:
All glass / dishwashers should be connected to a treated water supply when the local supply is over 10 HF / 6 HD.

Any issues derived from a bad installation that don't meet with the indicated conditions will not be considered as a warranty.

Water treatment

What you can achieve with treatment of water

Most of the water that comes out of the tap seems perfectly pure, however it may contain, as already mentioned, invisible contaminants. Removing these elements has a decisive influence on water quality.

Calcium and magnesium (hardness) are eliminated and the useful life of the equipment is significantly extended, reducing maintenance interventions and the use of detergents and rinse aids. Aspects that are anything but marginal in the Ho.Re.Ca.

	SOFTNER	REVERSE OSMOSIS
EXCELLENT WASH		X
SAVING DETERGENTS	X	X
REDUCES GLASS AND CERAMICS WEAR		X
PROTECTS THE MACHINE	X	X
GOODBYE MANUAL DRYING		X

Water treatment methods

Water treatment occurs mainly in two ways.

SOFTNER

The result obtained by using the water softener is to eliminate the calcium Ca²⁺ and magnesium Mg²⁺ ions, responsible for the hardness of the water. This effectively prevents the formation of encrustations which over time reduce the performance of the machines and cause malfunctions.

REVERSE OSMOSIS

Thanks to the very high degree of filtration that characterizes reverse osmosis machines, it is possible to obtain water with high quality characteristics. Water, passing through one or more Membranes, is deprived not only of the elements that determine its hardness, but also of all substances contaminants, responsible, for example, for unwanted odors and flavors.

For excellent results and long maintenance intervals, the two technologies can be combined.



Manual water softeners

For hardness bigger than 5 HF / 3 HD.

Manual maintenance required.

CODE	DESCRIPTION	CAPACITY OF REGENERATION (*)	DIMENSIONS (mm)	€	
	19004620	DESCALING KIT 8 L.	700 litres between 2 regenerations	Ø 185x440 mm	-
	19004690	DESCALING KIT 12 L.	1.050 litres between 2 regenerations	Ø 185x560 mm	-
	19004798	DESCALING KIT 16 L.	1.400 litres between 2 regenerations	Ø 185x740 mm	-

Reverse osmosis

GREAT ADVANTAGES OF REVERSE OSMOSIS:

- It reduces detergent use by up to 60% and rinse aid by 70-100%.
- It polishes plates, glasses and cutlery, obtaining a mark-free washing result since it does not require drying after the wash.
- It extends the life of glassware and dishes since it reduces corrosion.
- It protects the machinery, extending its life.

General characteristics



Inlet water conditions:

- Type of inlet water: drinking water.
- Inlet water temperature: 5 °C - 35 °C.
- Minimum flow: 400 l/h.
- Supply pressure: 1.5-6 bar.
- Maximum conductivity of inlet water: 1200 µS / cm.
- Maximum inlet water hardness: up to 35°f with pH below 8.5 and up to 27°f with pH above 8.5.
- As of 10°dH 15°dH or 27°f, we recommend installing a water softening system prior to osmosis to prevent blockage of the membrane.
- High-flow reverse osmosis system.
- Vertical or horizontal installation.
- Flow: 120 l/h at 15°C.
- Recovery rate from 25% to 60%.
- Typical rejection rate: 95 %.
- Electrical connection 230V ~ 50/60Hz.
- Prefilter that reduces and eliminates water turbidity, chlorine, tastes and smells. Its nominal filtration rate is 5 microns.
- Easy to install.
- Prefilter change alarm.
- Water leak alarm.
- Low-pressure alarm at system entrance.
- Manual bypass valve.

ONLY VALID FOR: AD-505, AD-125, COP-404, COP-504 y COP-144

MODEL	CODE	FLOW 15°C (L/H)	NUMBER OF MEMBRANES	VOLTAGE (V)	FREQUENCY (HZ)	POWER (KW)	DIMENSIONS (mm)	€
REVO-120	19076763	120	2	230	50 / 60	0,33	145 x 560 x 455	-

MODEL	CODE	DESCRIPTION	€
PREF-PACK6	19076764	Pack of 6 units of rapid-connection cartridges with extruded carbon block filter	-

Baskets for dishes, trays and cutlery

Made of polypropylene.

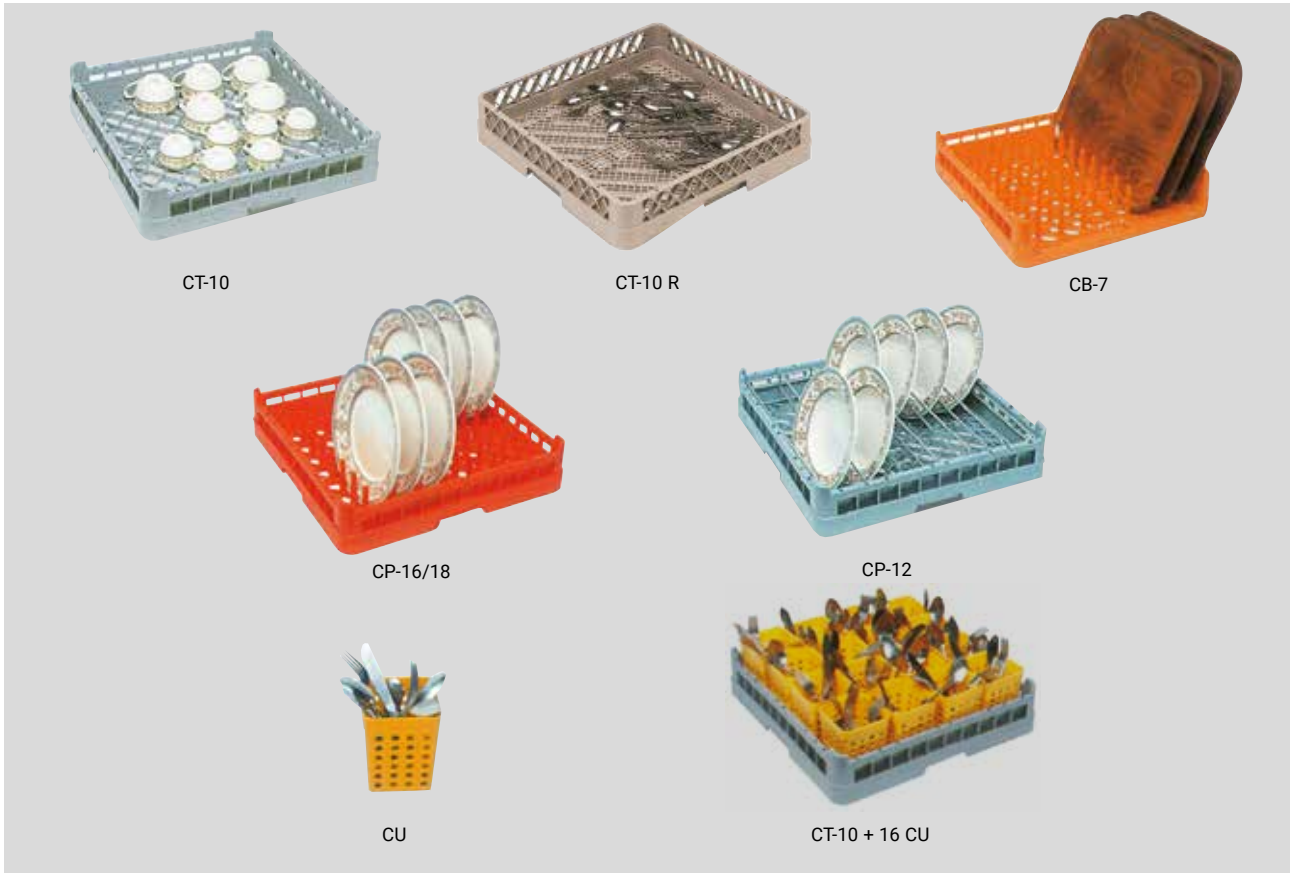

	MODEL	CODE	TYPE OF BASKET	Ø MAX (mm)	CAPACITY PRODUCT	COLOUR	DIMENSIONS (mm)	€	
		CT-10	19000484	Standard basket	Dishes	Grey	500x500x110	-	
		SMALL BASKET 400	19082432	Standard basket	Dishes	Grey	400x400x110	-	
		DISHES ACCESSORY 400	19084452				400x400x110	-	
		SMALL BASKET 350	19082434	Standard basket	Dishes	Grey	350x350x110	-	
		DISHES ACCESSORY 350	19084453				350x350x110	-	
		CT-10 R	19085091	Standard basket with dense base	Dishes and cutlery	Brown	500x500x110	-	
		CB-7	19000483	Trays for self-service	-	7	Orange	500x500x110	-
		CP-16/18	19000487	Dishes	Ø 230 Ø 320	16 ÷ 18 (*) 8 ÷ 9 (*)	Orange	500x500x110	-
		CP-12	19004479	Deep dishes	Ø 230 Ø 320	12 (*) 6 (*)	Grey	500x500x140	-
		CU	19000792	Cutlery	-	15 (**)	Yellow	105x105x130	-

Notes: (*) It depends of the position of the dishes in the basket.
(**) To guarantee a correct washing of the cutlery, it is not recommended to introduce more units.

Baskets for glasses

Made of polypropylene.



Baskets for 16 glasses and cups ø 110 mm

MODEL	CODE	TYPE OF BASKET	Ø MAX (mm)	H MAX (mm)	CAPACITY PRODUCT	COLOUR	DIMENSIONS (mm)	€
CV-16/105	19000488	Low glasses	110	100	16	Blue	500x500x140	-
CV-16/155	19000489	Medium glasses	110	150	16	Blue	500x500x190	-
CV-16/205	19000490	High glasses	110	200	16	Blue	500x500x240	-



Baskets for 25 glasses and cups ø 85 mm

MODEL	CODE	TYPE OF BASKET	Ø MAX (mm)	H MAX (mm)	CAPACITY PRODUCT	COLOUR	DIMENSIONS (mm)	€
CV-25/105	19000491	Low glasses	85	100	25	Blue	500x500x140	-
CV-25/155	19000492	Medium glasses	85	150	25	Blue	500x500x190	-
CV-25/205	19000493	High glasses	85	200	25	Blue	500x500x240	-

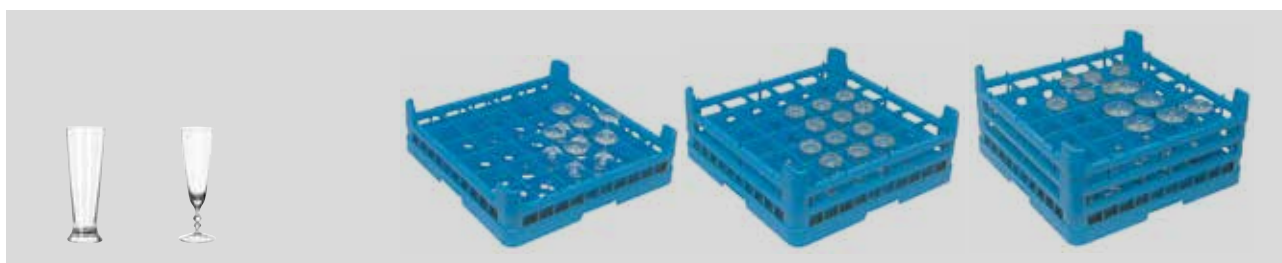

Baskets for 36 glasses and cups ø 70 mm

MODEL	CODE	TYPE OF BASKET	Ø MAX (mm)	H MAX (mm)	CAPACITY PRODUCT	COLOUR	DIMENSIONS (mm)	€
CV-36/105	19000494	Low glasses	70	100	36	Blue	500x500x140	-
CV-36/155	19000495	Medium glasses	70	150	36	Blue	500x500x190	-
CV-36/205	19000496	High glasses	70	200	36	Blue	500x500x240	-





Annexes

Terms and conditions of sale

01. Prices

All prices included in our invoices are in euro, net ex works. Prices exclude delivery, unloading, positioning or installation.

02. Transport

Goods are freighted under buyer's responsibility.

Delivery is free on truck: unloading not included.

Complains: goods are freighted under insurance coverage. It is clients' task to check goods for damages upon delivery.

Complains not related to transportation must be sent within 5 days from goods reception.

Besides above mentioned cases, goods received with signature on shipping bulletin are accepted henceforth.

03. Packing

Standard packing is included in the present prices. Other packing will be quoted separately.

04. Guarantee

We warranty all our products against manufacturer fault during ONE YEAR from manufacturer or expedition date.

The faulty parts will be replaced with an ex-works delivery.

We shall not be obliged to replace any goods or make any allowance or other arrangement if the defect has arisen from accident, misuse, neglect, incorrect installation, or any other cause beyond our control.

Where the defect is reasonably attributable to the fault of the manufacturer, the Manufacturer shall replace or repair the defective goods but shall not be liable for any cost of removal of the defective goods, or of the installation of replacement or any consequential loss or damage arisen there from.

The manufacturer's liability shall be limited to the repair or replacement of materials and components manufactured by us.

Where goods and components supplied by us are not of our design and manufacture, the liability shall be limited to the guarantee provided by the manufacture of such goods and components.

05. Publications

Right of new developments and technical modifications reserved.

Prices and article numbers subject to change without notice.

This price list supersedes all earlier lists.

Specifications :

Some previous considerations have to be mentioned here that before were not indicated because we had considered as obviously clear for every one.

The technical descriptions of our machines try to give a description of the main characteristics, nevertheless the revisions of the industrial process could produce modifications of any of these values.

Fagor Industrial has the right to introduce the modifications that could be considered necessary if they do not modify the main characteristics and requirements of the machine.

06. Delay

Time for performance by the Manufacturer is given in good faith, as accurately as possible, but is not to be the essence of the contract. The Customer shall have no right to damages or to impose penalties in the event of late delivery by the Manufacturer or his clients, or to cancel the order or the contract for delay from any causes unless agreed in writing by the Manufacturer.

Delivery terms are merely indicative and subject to FAGOR production times. Delays do not entitle to any refund or liability whatsoever.

07. Cancellation and restocking

The Manufacturer at its absolute discretion may agree to the return of goods by the customer provided that the goods are returned at the customer expense, in the same condition and in the original packing.

Any goods agreed by the Manufacturer as acceptable for return for any reason, excluding faulty goods, will be subject to a restocking charge of 35 % of the net invoice value.

7-1. Orders can not be cancelled if they have been confirmed and accepted in writing, specially tailor made equipment.

We'll consider any order confirmed if we don't receive any negative reaction in 24 hours from our confirmation date.

7-2. Fagor Industrial will only accept any cancellation as follows :

- If the dealer's cancel is before goods have left our warehouse a 50.00 € charge, net, per item will be made to cover our administration and logistics cost.
- If the dealer's cancel is after goods have left our warehouse, a charge of 20 % of invoice value will be charged plus an abortive delivery charge if it is necessary.
- If the goods had been unpacked, a minimum of 25 % of invoice value will be charged only for this concept.

08. Payments

The payments will be made on time, even if the transport, the setting in service or the reception of the installation are delayed or canceled by reasons that are not attributable to us.

09. Arbitration

The Parties should try to settle any disputes and differences which can arise by negotiations. If the parties will not come to agreement, the arisen dispute will be submitted for consideration to a neutral Court as it is The International Commercial Arbitration court of Paris, the arbitrator would also know and speak English and Spanish.

Conversion factors

LENGTH AND SURFACE		
UNIT	FACTOR	UNIT
cm	0.3937	inch
mm	0.0394	inch
inch	2.54	cm
inch	25.4	mm
m	32.808	foot
foot	0.3048	m
m	10.936	yard
yard	0.9144	m
dm ²	15.5	inch ²
inch ²	0.0645	dm ²

VOLUME		
UNIT	FACTOR	UNIT
gallon	3.785	litre
litre	0.2642	gallon
m ³	35.31	foot ³
foot ³	0.0283	m ³
inch ³	16.39	cm ³
cm ³	0.061	inch ³
litre	61	inch ³
inch ³	0.0164	litre

PRESSURE		
UNIT	FACTOR	UNIT
kg/cm ²	14.22	pound/inch ²
pound/inch ²	0.07	kg/cm ²
kg/cm ²	0.9807	bar
bar	1.020	kg/cm ²
Pa	10 5	bar
bar	10 5	Pa

POWER AND ENERGY		
UNIT	FACTOR	UNIT
kcal/h	1/860	kW
kW	860	kcal/h
kcal/h	4	BTU
BTU	0.25	kcal/h
cal	4.186	J
J	0.2389	cal
kcal	1000	cal
Th	1000	kcal
kW	13.406	H.P.
H.P.	0.746	kW
kW	1.36	C.V.
C.V.	0.7357	kW

WEIGHT		
UNIT	FACTOR	UNIT
pound	453.6	g
g	1/453.6	pound
pound	0.4536	kg
kg	22.045	pound

TEMPERATURE AND HOT		
$^{\circ}\text{C} = (5/9) \times (^{\circ}\text{F} - 32)$		
$^{\circ}\text{F} = (9/5) \times ^{\circ}\text{C} + 32$		
$^{\circ}\text{K} = 273 ^{\circ}\text{C}$		
Thermia 1000 kcal		



ONNERA GROUP

