



Shaping The Ice





We are Brema

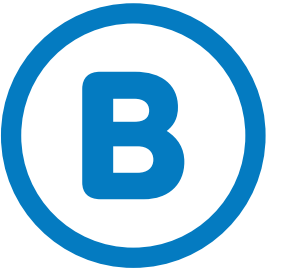

**Fare il ghiaccio è il nostro mestiere
Farlo con cura e passione è la nostra missione**

Precisione e puntualità sono il nostro modo di essere.

L'etica nei rapporti commerciali, la trasparenza nella conduzione dell'impresa e il rispetto delle istituzioni in ogni Paese del mondo sono in sintesi i principi sui quali si fonda la nostra attività.

Siamo certificati UNI EN ISO 9001:2008 a garanzia della qualità dei nostri processi aziendali.

**Making ice is our business
Doing it with passion and care is our mission**

Precision and punctuality are our way of being.

Ethics in trading, transparency in managing the Company and respect for the institutions of every Country in the world summarise the principles which underpin our business.

We are certified UNI EN ISO 9001:2008 to guarantee the quality of our business processes.

Company Certifications



Designing the water

Imparare dal mondo
Learn from the world

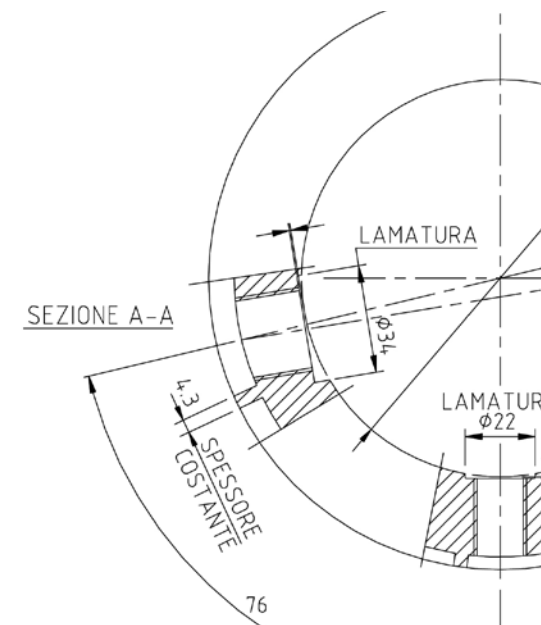

Dal 1985 pensiamo al ghiaccio come evoluzione dell'acqua, disegnandolo nelle forme ideali per rispondere a ogni tipo di esigenza.

I bisogni e le caratteristiche dei singoli mercati sono i principi sui quali abbiamo sviluppato la nostra gamma di prodotti.

Since 1985 we have considered ice as an evolution of water, designing it into forms suitable to meet every need.

The requirements and features of each market are the principles on which we have developed our range of products.

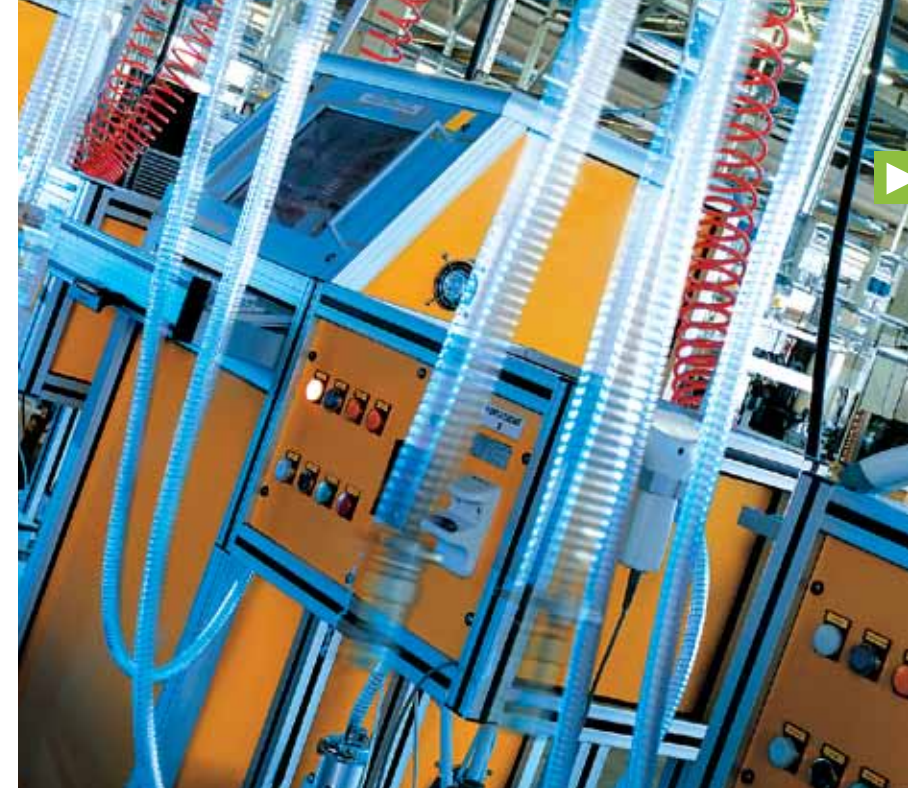

► Be Certified

Il ghiaccio che dà sicurezza

Oltre alla marcatura CE, l'intera gamma dei nostri prodotti ha ottenuto l'approvazione TÜV Rheinland, che permette a ogni macchina di essere riconosciuta dagli organismi di certificazione internazionali.

Abbiamo conseguito inoltre le certificazioni NSF, ETL Listed Mark, ETL Sanitation Mark, KC, UKR, S-Mark, WRAS e RCM.

Tutti i nostri prodotti sono certificati in classe tropicale (+43°C).

Ice that gives you confidence

In addition to the CE mark, the full range of our products is certified by TÜV Rheinland allowing our machines to be recognised by international certification bodies.

In addition, our products also carry NSF, ETL Listed Mark, ETL Sanitation Mark, KC, UKR, S-Mark, WRAS and RCM certifications.

All our products are tropical class certified (+43°C).

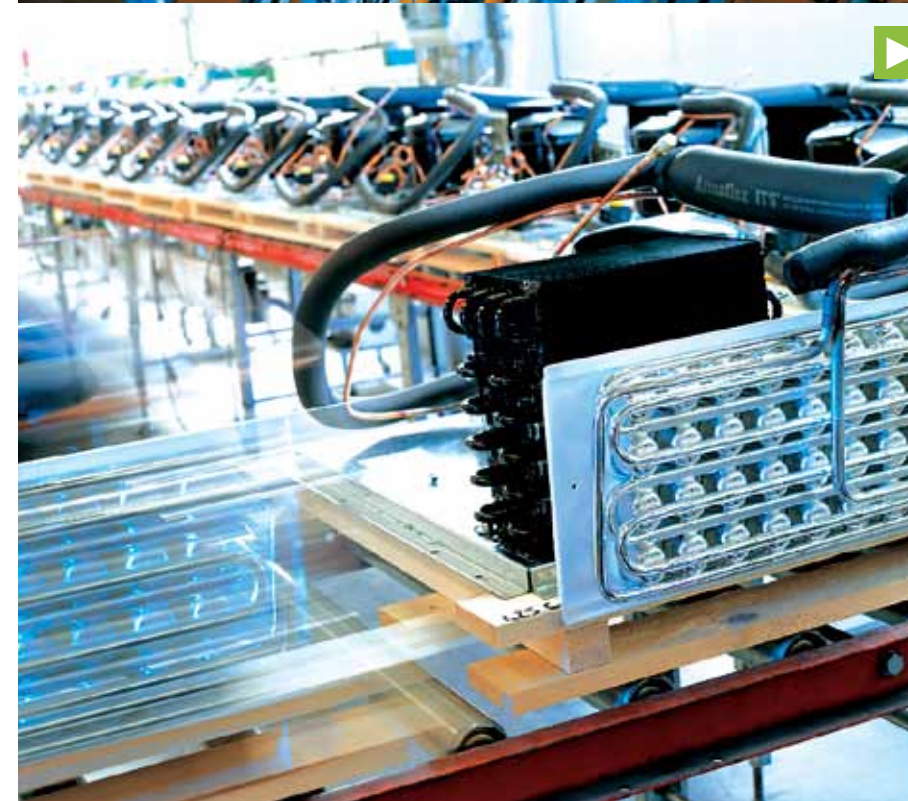

► Be Eco-active

Rispettiamo l'ambiente e chi lo vive

Vogliamo contribuire con le nostre scelte a un futuro più ecosostenibile, per questo progettiamo macchine "designed for the environment".

L'ultima testimonianza è lo studio di nuovi gas refrigeranti.

Dal 2003 abbiamo adottato un codice etico aziendale a garanzia di un comportamento ECO e rispettoso nei confronti del prossimo.

We respect the environment and those who live in it

We want to contribute with our choices to a more eco-sustainable future. Our machines are "designed for the environment". The latest proof is our work with new refrigeration gases.

Since 2003 we follow a corporate Code of Ethics to ensure an Ecologically conscious behaviour and respect towards others.

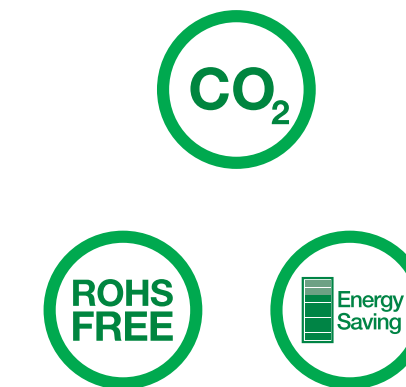

Focus on the Quality

Da oltre trent'anni una filosofia di produzione

A production philosophy for over 30 years

Ogni macchina Brema ha la sua storia. Durante la fase di produzione controlliamo e registriamo i processi ai quali è sottoposta la macchina. I risultati sono raccolti e inseriti in un unico documento, a garanzia della totale tracciabilità di tutti gli elementi installati e delle prove svolte. Tutte le macchine, dopo un accurato collaudo funzionale, escono dagli stabilimenti Brema con un proprio passaporto che ci permette di seguirle ovunque nel mondo.

Every Brema machine has its own history. During the production stage we check and record the processes the machines are subjected to. The results are collected and entered into a single document, to guarantee complete traceability of all installed components and tests performed. After an accurate functional check, all machines leave the Brema factories with their own passport that allows us to follow them all over the world.

8 Steps to Quality

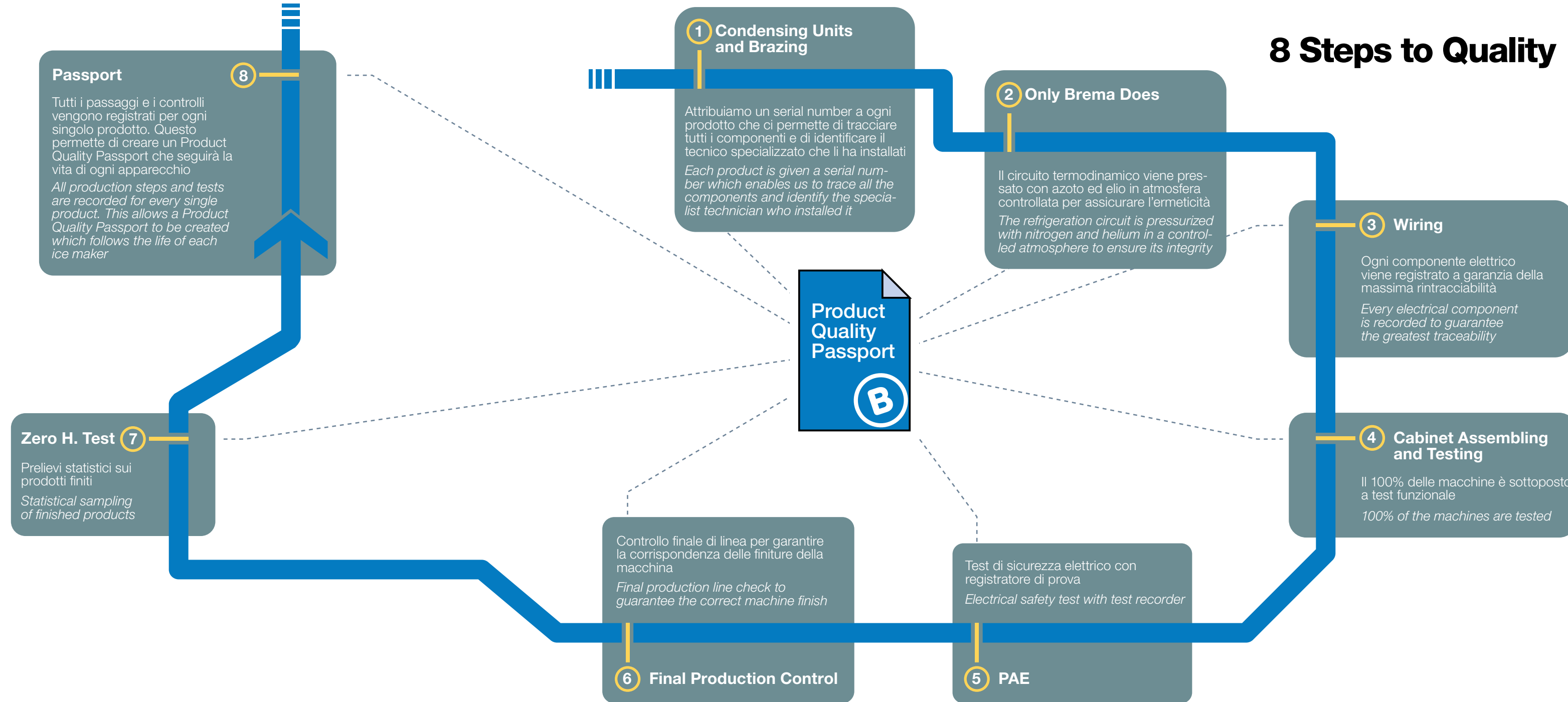

Ice for every needs

Di che ghiaccio sei?
Which ice are you?

Ogni mercato ha le sue esigenze.

Studiando le proprietà del ghiaccio abbiamo sviluppato diverse forme per soddisfare le richieste di ogni settore e i più svariati bisogni.

Le nostre macchine trovano applicazione nell'Ho.Re.Ca, GDO, nei trasporti, nella conservazione degli alimenti, nel settore ittico, della panificazione, lattiero-caseario, chimico, farmaceutico, medicale, sportivo, wellness, industriale ed edile.

Every market has its requirements.

By studying the ice properties we've developed different forms to satisfy the demands and needs of each sector.

Our machines are used in the Ho.Re.Ca , retail, transport, food preservation, fish, bakery, dairy, chemical, pharmaceutical, medical, sports, wellness, industrial and construction sectors.

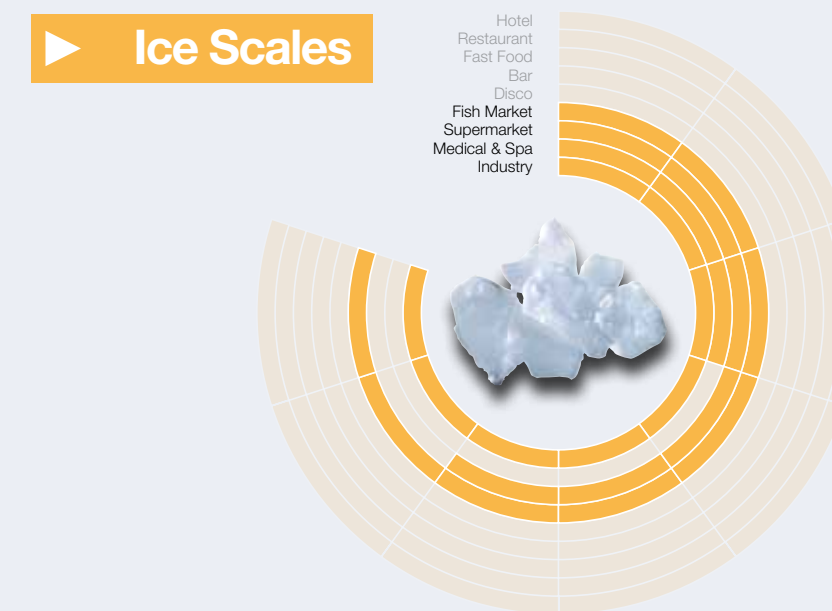
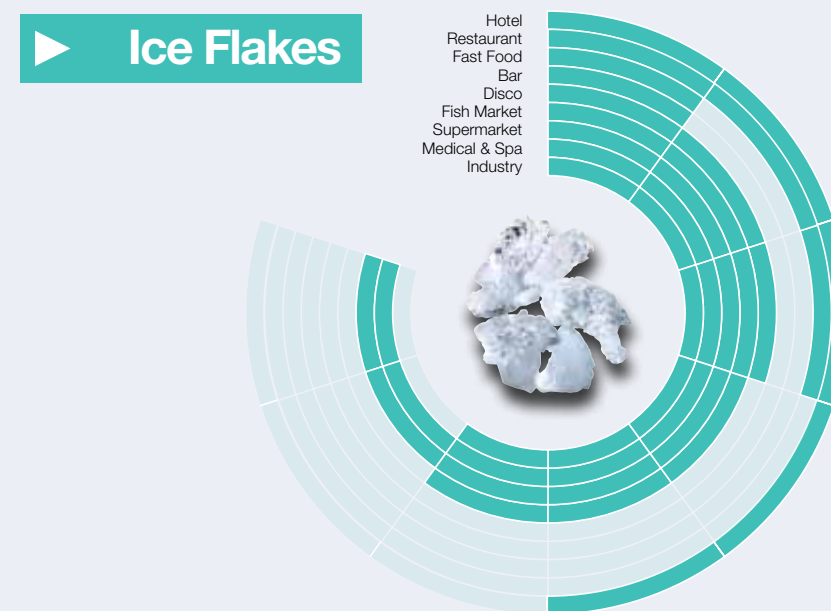
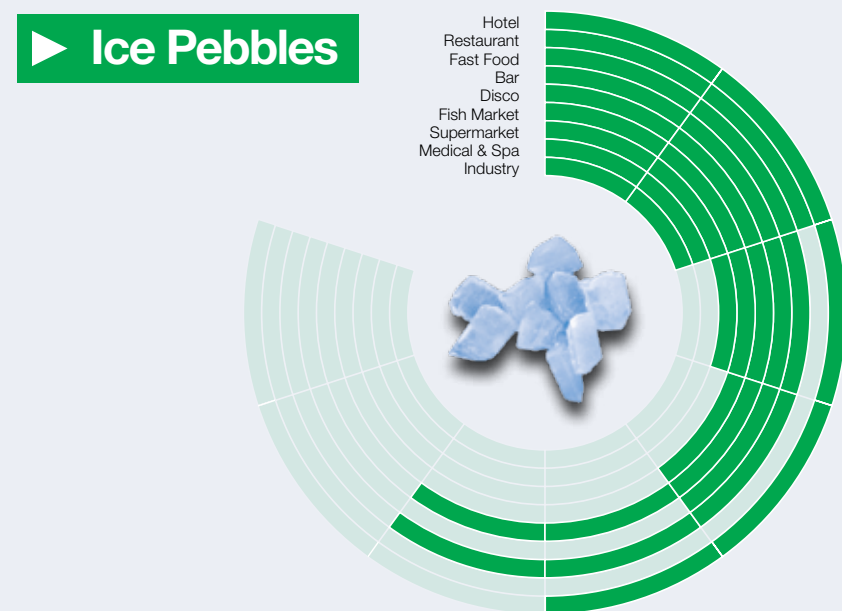
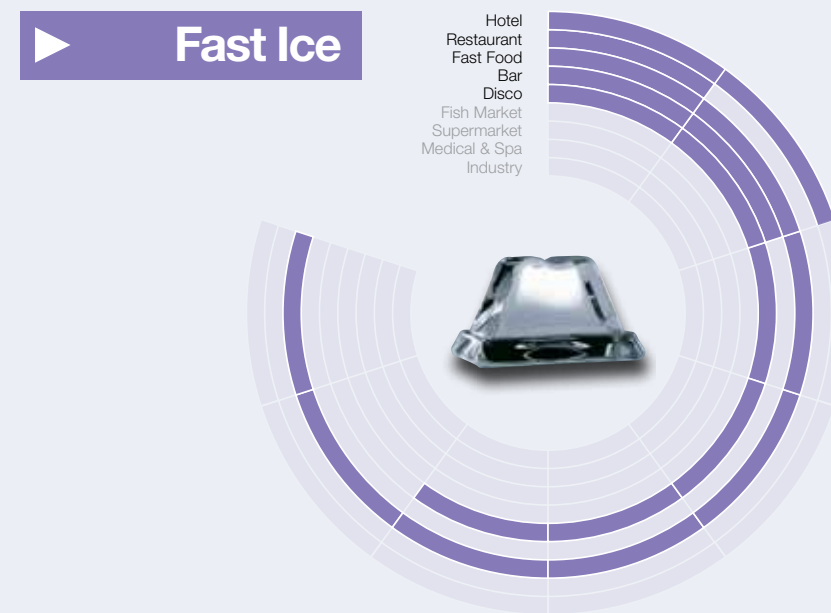
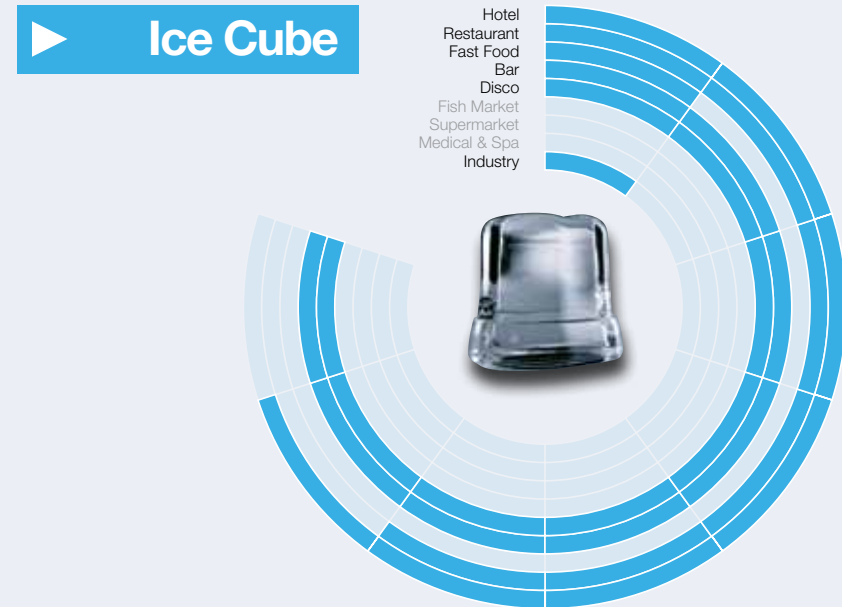

Ice Cube

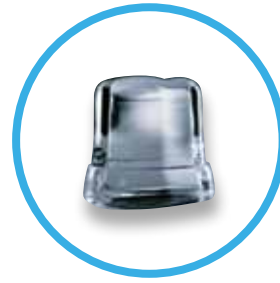

Cubetto singolo,
compatto e cristallino

*Single cube, compact
and crystalline*

Si apprezza per l'aspetto elegante e per le sue elevate prestazioni.

La forma a tronco di cono e i lati leggermente schiacciati lo rendono adatto a ogni tipo di bicchiere.

Offriamo una vasta gamma di macchine, dalle più piccole con contenitore incorporato, alle modulari per grosse produzioni giornaliere. Ice Cube può essere ordinato in differenti dimensioni e grammature: 13, 18, 33, 42 e 60 grammi.

Al mercato la scelta!

Is appreciated for the elegant look and for its high performance.

The truncated cone shape with slightly crushed sides make them suitable for all types of glasses.

We offer a wide range of machines, from the smallest self-contained units to modular units for large daily productions.

Ice Cube can be ordered in different sizes and weights: 13, 18, 33, 42 and 60 grams.

Market choice!

Ice Cube
fields of use

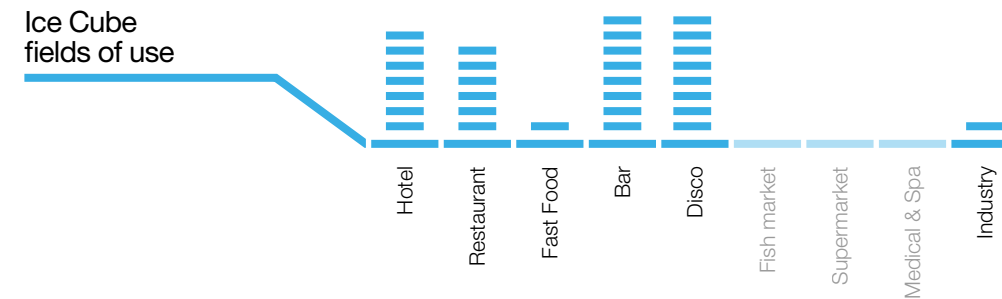

Mirko

Bartender needs ice



Sprayer System Technology



Spruzzando acqua su di un evaporatore orizzontale le molecole più pure formano il ghiaccio mentre le altre, ricche di minerali, ricadono nella vasca interna e vengono successivamente rimosse al termine di ogni ciclo di produzione.

Il risultato: un cubetto puro e cristallino.

The purest water forms ice by being sprayed onto a horizontal evaporator while the mineral rich water returns to the internal tank and is subsequently removed at the end of the production cycle.

The result is a pure and crystalline cube.

- 20 modelli di gamma, da 22 kg a 300 kg / 24h
20 models range from 22 kg to 300 kg/24 hrs
- Classe Tropicale +43° C
Tropical class +43° C
- Carrozzeria AISI 304 Scotch brite
AISI 304 SS Scotch brite finishing
- Funzionamento elettromeccanico
Electromechanical operation

Fast Ice

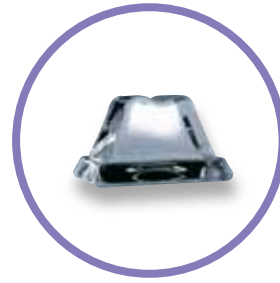

Il singolo cubetto verticale
The single vertical cube

Cubetti freschi e leggeri, dalla forma a tronco di piramide, con molte sfaccettature che permettono di trasmettere velocemente il freddo alle bevande.

Fresh, light cubes with a truncated pyramid shape and many facets that help cold to the drink.

Fast Ice
fields of use

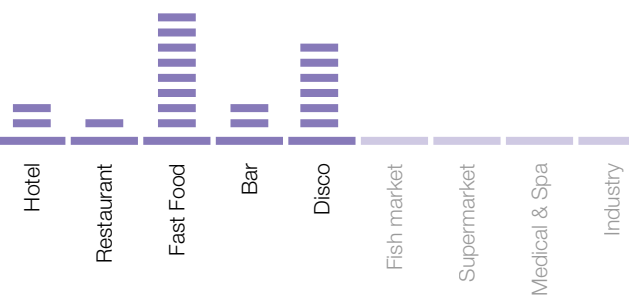

Matias
Waiter needs ice

▶ Fast Ice Technology



Questo ghiaccio si forma su un evaporatore verticale, simile a uno stampo per cioccolatini, che garantisce grandi produzioni in tempi brevi. I cubetti si staccano singolarmente e cadono nel contenitore di raccolta perfettamente separati l'uno dall'altro e di eguale dimensione garantendo un buon dosaggio.

This ice is formed on a vertical evaporator, similar to a mould for chocolates, which guarantees large production quantities in a short time. The cubes fall individually into the collection bin, perfectly separated and with the consistent size, ensuring good dosage.

- 5 modelli di gamma, da 105 kg a 770 kg / 24h
5 models range from 105 kg to 770 kg/24 hrs
- Classe Tropicale +43° C
Tropical class +43° C
- Carrozzeria AISI 304 Scotch brite
AISI 304 SS Scotch brite finishing
- Cubetto singolo e cristallino
Compact and crystal cube

Ice Finger



Un tocco di freschezza
A touch of freshness

Questo cubetto dall'originale forma a ditale raffredda velocemente le bevande grazie alla sua ampia superficie di contatto. Grazie al sistema di produzione del ghiaccio a immersione, risulta particolarmente adatto in caso di acque molto dure.

This cube, with the original thimble shape, cools drinks quickly because of its large surface area. Due to the immersion production system, this ice is particularly suitable in case of hard water.

Ice Finger
fields of use

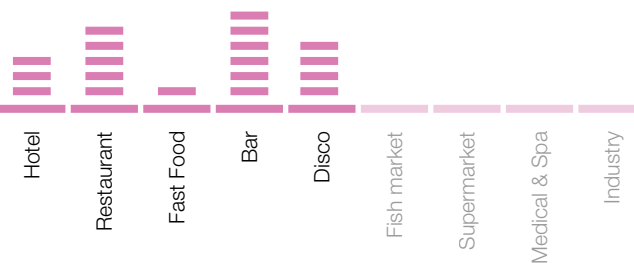

Daniel

Waiter needs ice



Paddle System Technology



L'Ice Finger si forma attraverso l'immersione di peduncoli sottoraffreddati all'interno di una bacinella colma d'acqua. Il risultato: è un cubetto cristallino.

The Ice Finger is formed by immersing sub-cooled metal stalks into a tray of water. The result: a crystal cube

- 5 modelli di gamma, da 25 kg a 75 kg / 24h
5 models range from 25 kg to 75 kg/24 hrs
- Classe Tropicale +43° C
Tropical class +43° C
- Carrozzeria AISI 304 Scotch brite
AISI 304 SS Scotch brite finishing
- Compatibile con acque dure
Suitable for use with hard water

Ice Pebbles



Il “micro-cube” multiuso

The multiuse “micro-cube”

È l'eclettico ghiaccio del futuro protagonista indiscusso dei nostri prodotti.

Un micro-cubetto è il un punto d'incontro tra il fast-ice e il classico granulare, particolarmente versatile e adatto a svariati utilizzi.

Grazie alla sua forma e alle sue specifiche di raffreddamento è ideale per la realizzazione di cocktail, buffet e per la presentazione dei prodotti ittici.

This is the eclectic ice of the future and undisputed star of our products.

A micro-cube is the meeting point between fast-ice and the classic flake ice – particularly versatile and suitable for many uses.

Due to its shape and fast cooling ability, it is ideal for cocktails as well as seafood and buffet presentation.

Ice Pebbles fields of use

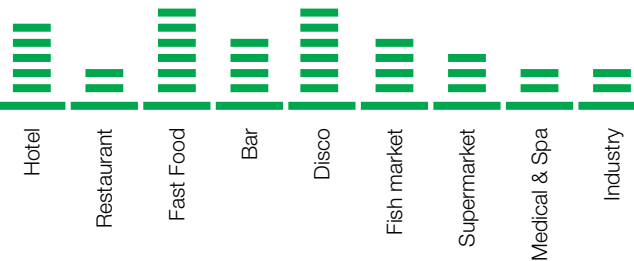

Kate

Bartender needs ice

▶ Pebble System Technology



L'azione combinata di una coclea e di una trafilata consente una produzione continua a ciclo stabilizzato. L'affidabilità dei componenti garantisce bassi costi di gestione e una produzione molto efficiente di ghiaccio.

The combined action of an auger and an extruder allows continuous production in a stable cycle. The reliability of the components ensures low operating costs and high efficiency ice production.

- 7 modelli di gamma, da 55kg a 440kg / 24h
7 models range from 55 kg to 440 kg/24 hrs
- Classe Tropicale +43° C
Tropical class +43° C
- Carrozzeria AISI 304 Scotch brite
AISI 304 SS Scotch brite finishing
- Pebbles compatti, 91% secco
Compact pebbles, 91% dry
- 1 l di acqua = 1 kg di ghiaccio
(solo per modelli raffreddati ad aria)
1 l water = 1 kg ice (only air cooled)

Ice Flakes



Ghiaccio versatile e decorativo

Flexible and decorative ice

Il ghiaccio granulare è il principale protagonista nella presentazione di vari prodotti. Le caratteristiche principali sono la temperatura poco sotto agli 0°C e la sua malleabilità che permette estro nell'esposizione. Trova impiego nei settori GDO, Ho.RE.CA, wellness, sportivo, medicale e ittico.

Flakes are the real protagonist in the presentation. The main features are its temperature just below 0°C and its malleability, which allows for creativity in display design. It is used in the retail, Ho. Re.Ca., wellness, sports, medical and fish sectors.

Ice Flakes fields of use

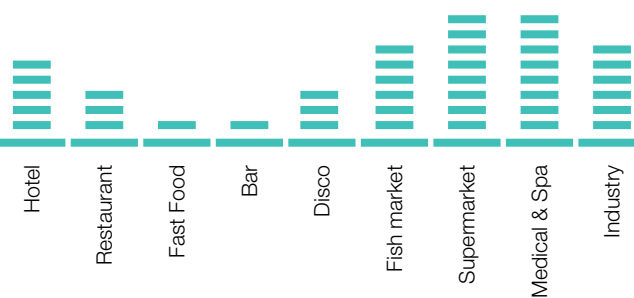

Yu Bao

Fishmonger needs ice

▶ Granular System Technology



La combinazione di una coclea e di un rompighiaccio genera granuli con forma irregolare. La semplicità del processo produttivo consente bassi costi di gestione.

The combination of an auger and an ice-breaker generates grains with irregular shape. The simplicity of the production process allows low operating costs.

- 13 modelli di gamma, da 60 kg a 1.000 kg / 24h
13 models range from 60 kg to 1,000 kg/24 hrs
- Classe Tropicale +43° C
Tropical class +43° C
- Carrozzeria AISI 304 Scotch brite
AISI 304 SS Scotch brite finishing
- Disponibile per CO₂
CO₂ application
- 1 l di acqua = 1 kg di ghiaccio (solo per modelli raffreddati ad aria)
1 l water = 1 kg ice (only air cooled)

Ice Scales



Scaglie di ghiaccio sottoraffreddate che durano nel tempo

Sub-cooled flakes for long term conservation

Dotate di un alto potere refrigerante la loro temperatura varia tra i -5°C ai -10°C , spessore da 1,5 mm a 3 mm.

È un ghiaccio particolarmente freddo e studiato per applicazioni specifiche come industria ittica, chimica, edile, lattiero-casearia e nelle lavorazioni delle carni.

Defined by high cooling power, their temperatures change from -5°C to -10°C and thickness from 1.5 mm to 3 mm.

It is a particularly cold ice developed for specific applications like the fishing, chemical, construction, dairy, and meat processing industries.

Ice Scales fields of use

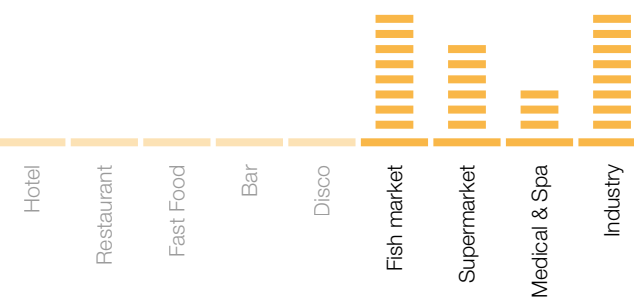

Gael

Fisherman needs ice

Fixed Vertical Evaporator System



Il nostro sistema è realizzato con materiali di altissima qualità, un evaporatore fisso garantisce l'ermeticità e tenuta del circuito, produce una scaglia fredda e secca ottenuta attraverso la rotazione di una lama.

Our system is produced with very high quality materials, a fixed evaporator guarantees the integrity of the circuit, and produces super-cooled and dry ice flakes through a rotating blade.

- 14 modelli di gamma, da 250 kg a 2.300 kg / 24h
14 models range from 250 kg to 2,300 kg/24 hrs
- Classe Tropicale +43° C
Tropical class +43° C
- Carrozzeria AISI 304 Scotch brite
AISI 304 SS Scotch brite finishing
- Disponibile per CO₂
CO₂ application
- 1 l di acqua = 1 kg di ghiaccio (solo per modelli raffreddati ad aria)
1 l water = 1 kg ice (only air cooled)

Ice Cube



▶ CB Series



▶ C Series



▶ Special Series



	CB 184	Produzione 24h* Production 24h	22 kg - 49 lbs
	Capacità contenitore Storage Capacity	fino a/up to: 4 kg - 9 lbs	
	Condensazione Cooling system	A - W	
	Tipo di cubetto Kind of cube	D-13g	
	Consumo elettrico** Electrical consumption	320 W	
	Dimensioni (LxPxH) * Sizes (WxDxH)	355 x 404 x 590 mm 14 x 15 14/16 x 23 4/16 "	
Peso netto Net weight	27,5 kg - 61 lbs		
Fusibile Fuse	10 A		

	CB 246	Produzione 24h* Production 24h	26 kg - 57 lbs
	Capacità contenitore Storage Capacity	fino a/up to: 6 kg - 13 lbs	
	Condensazione Cooling system	A - W	
	Tipo di cubetto Kind of cube	A-18g, C-33g, D-13g, E-42g	
	Consumo elettrico** Electrical consumption	350 W	
	Dimensioni (LxPxH) * Sizes (WxDxH)	390 x 460 x 610 mm 15 6/16 x 18 2/16 x 24 "	
Peso netto Net weight	35 kg - 77 lbs		
Fusibile Fuse	10 A		

	CB 249	Produzione 24h* Production 24h	29 kg - 64 lbs
	Capacità contenitore Storage Capacity	fino a/up to: 9 kg - 20 lbs	
	Condensazione Cooling system	A - W	
	Tipo di cubetto Kind of cube	A-18g, C-33g, D-13g, E-42g	
	Consumo elettrico** Electrical consumption	370 W	
	Dimensioni (LxPxH) * Sizes (WxDxH)	390 x 460 x 690 mm 15 6/16 x 18 2/16 x 27 3/16 "	
Peso netto Net weight	37 kg - 82 lbs		
Fusibile Fuse	10 A		

	CB 316	Produzione 24h* Production 24h	35 kg - 77 lbs
	Capacità contenitore Storage Capacity	fino a/up to: 16 kg - 35 lbs	
	Condensazione Cooling system	A - W	
	Tipo di cubetto Kind of cube	A-18g, C-33g, D-13g, E-42g	
	Consumo elettrico** Electrical consumption	370 W	
	Dimensioni (LxPxH) ** Sizes (WxDxH)	500 x 580 x 690 mm 19 11/16 x 22 13/16 x 27 3/16 "	
Peso netto Net weight	48 kg - 106 lbs		
Fusibile Fuse	10 A		

	CB 416	Produzione 24h* Production 24h	44 kg - 97 lbs
	Capacità contenitore Storage Capacity	fino a/up to: 16 kg - 35 lbs	
	Condensazione Cooling system	A - W	
	Tipo di cubetto Kind of cube	A-18g, C-33g, D-13g, E-42g	
	Consumo elettrico** Electrical consumption	450 W	
	Dimensioni (LxPxH) ** Sizes (WxDxH)	500 x 580 x 690 mm 19 11/16 x 22 13/16 x 27 3/16 "	
Peso netto Net weight	52 kg - 115 lbs		
Fusibile Fuse	10 A		

	CB 425	Produzione 24h* Production 24h	47 kg - 104 lbs
	Capacità contenitore Storage Capacity	fino a/up to: 25 kg - 55 lbs	
	Condensazione Cooling system	A - W	
	Tipo di cubetto Kind of cube	A-18g, C-33g, D-13g, E-42g	
	Consumo elettrico** Electrical consumption	500 W	
	Dimensioni (LxPxH) ** Sizes (WxDxH)	500 x 580 x 800 mm 19 11/16 x 22 13/16 x 31 8/16 "	
Peso netto Net weight	56 kg - 123 lbs		
Fusibile Fuse	10 A		

	CB 640	Produzione 24h* Production 24h	67 kg - 148 lbs
	Capacità contenitore Storage Capacity	fino a/up to: 40 kg - 88 lbs	
	Condensazione Cooling system	A - W	
	Tipo di cubetto Kind of cube	A-18g, C-33g, D-13g, E-42g	
	Consumo elettrico** Electrical consumption	650 W	
	Dimensioni (LxPxH) ** Sizes (WxDxH)	738 x 600 x 920 mm 29 1/16 x 23 10/16 x 36 4/16 "	
Peso netto Net weight	77 kg - 170 lbs		
Fusibile Fuse	10 A		

	CB 674	Produzione 24h* Production 24h	67 kg - 148 lbs
	Capacità contenitore Storage Capacity	fino a/up to: 40 kg - 88 lbs	
	Condensazione Cooling system	A - W	
	Tipo di cubetto Kind of cube	A-18g, C-33g, D-13g, E-42g	
	Consumo elettrico** Electrical consumption	650 W	
	Dimensioni (LxPxH) ** Sizes (WxDxH)	738 x 600 x 851,5 mm 29 1/16 x 23 10/16 x 33 8/16 "	
Peso netto Net weight	72 kg - 159 lbs		
Fusibile Fuse	10 A		

	CB 840	Produzione 24h* Production 24h	85 kg - 187 lbs
	Capacità contenitore Storage Capacity	fino a/up to: 40 kg - 88 lbs	
	Condensazione Cooling system	A - W	
	Tipo di cubetto Kind of cube	A-18g, C-33g, D-13g, E-42g	
	Consumo elettrico** Electrical consumption	800 W	
	Dimensioni (LxPxH) ** Sizes (WxDxH)	738 x 600 x 920 mm 29 1/16 x 23 10/16 x 36 4/16 "	
Peso netto Net weight	86 kg - 190 lbs		
Fusibile Fuse	10 A		

	CB 955	Produzione 24h* Production 24h	95 kg - 209 lbs
	Capacità contenitore Storage Capacity	fino a/up to: 55 kg - 121 lbs	
	Condensazione Cooling system	A - W	
	Tipo di cubetto Kind of cube	A-18g, C-33g, D-13g, E-42g	
	Consumo elettrico** Electrical consumption	850 W	
	Dimensioni (LxPxH) ** Sizes (WxDxH)	738 x 600 x 1020 mm 29 1/16 x 23 10/16 x 40 3/16 "	
Peso netto Net weight	89 kg - 196 lbs		
Fusibile Fuse	10 A		

	CB 1265	Produzione 24h* Production 24h	130 kg - 287 lbs
	Capacità contenitore Storage Capacity	fino a/up to: 65 kg - 143 lbs	
	Condensazione Cooling system	A - W	
	Tipo di cubetto Kind of cube	A-18g, C-33g, D-13g, E-42g, B-60g	
	Consumo elettrico** Electrical consumption	1050 W	
	Dimensioni (LxPxH) ** Sizes (WxDxH)	840 x 740 x 1075 mm 33 1/16 x 29 2/16 x 42 5/16 "	
Peso netto Net weight	113 kg - 249 lbs		
Fusibile Fuse	16 A		

	CB 1565	Produzione 24h* Production 24h	155 kg - 342 lbs
	Capacità contenitore Storage Capacity	fino a/up to: 65 kg - 143 lbs	
	Condensazione Cooling system	A - W	
	Tipo di cubetto Kind of cube	A-18g, C-33g, D-13g, E-42g, B-60g	
	Consumo elettrico** Electrical consumption	1400 W	
	Dimensioni (LxPxH) ** Sizes (WxDxH)	840 x 740 x 1075 mm 33 1/16 x 29 2/16 x 42 5/16 "	
Peso netto Net weight	118 kg - 260 lbs		
Fusibile Fuse	16 A		

	C 150	Produzione 24h* Production 24h	155 kg - 342 lbs
	Condensazione Cooling system	A - W	
	Tipo di cubetto Kind of cube	A-18g, C-33g, D-13g, E-42g, B-60g	
	Consumo elettrico** Electrical consumption	1400 W	
	Dimensioni (LxPxH) Sizes (WxDxH)	862 x 555 x 720 mm 33 15/16 x 21 14/16 x 28 6/16 "	
	Peso netto Net weight	118 kg - 260 lbs	
Fusibile Fuse	16 A		
Bin utilizzabile Usable bin	Bin 240PE - Bin 200 Bin 350		

	C 300	Produzione 24h* Production 24h	300 kg - 661 lbs
	Condensazione Cooling system	A - W	
	Tipo di cubetto Kind of cube	A-18g, C-33g, D-13g, E-42g, B-60g	
	Consumo elettrico** Electrical consumption	2600 W	
	Dimensioni (LxPxH) Sizes (WxDxH)	1250 x 580 x 848 mm 49 3/16 x 22 13/16 x 33 6/16 "	
	Peso netto Net weight	152 kg - 335 lbs	
Fusibile Fuse	32 A		
Bin utilizzabile Usable bin	Bin 350		

	C 300 Split	Produzione 24h* Production 24h	300 kg - 661 lbs
	Tipo di cubetto Kind of cube	A-18g, C-33g, D-13g, E-42g, B-60g	
	Consumo elettrico** Electrical consumption	200 W	
	Potenza frigorifera Cooling capacity	6000 W (evap. temp. inizio ciclo -12°C evap. temp. fine ciclo -28°C) (evap. temp. production cycle start -12°C, end -28°C)	
	Dimensioni (LxPxH) Sizes (WxDxH)	990 x 585 x 850 mm 39 x 23 1/16 x 33 7/16 "	
	Peso netto Net weight	97 kg - 214 lbs	
Bin utilizzabile Usable bin	Bin 350		

Fresh Maker



Produzione 24h* 22 kg - 49 lbs
Production 24h

Capacità contenitore fino a/up to: 4 kg - 9 lbs
Storage Capacity

Condensazione W
Cooling system

Tipo di cubetto D-13g
Kind of cube

Consumo elettrico** 320 W
Electrical consumption

Dimensioni (LxPxH) * 540 x 430 x 435 mm
Sizes (WxDxH) 21 4/16 x 16 15/16 x 17 2/16 "

Peso netto 37,5 kg - 83 lbs
Net weight

Fusibile 10 A
Fuse

IC 18



Produzione 24h* 22 kg - 49 lbs
Production 24h

Capacità contenitore fino a/up to: 4 kg - 9 lbs
Storage Capacity

Condensazione A
Cooling system

Tipo di cubetto D-13g
Kind of cube

Consumo elettrico** 320 W
Electrical consumption

Dimensioni (LxPxH) * 540 x 430 x 470 mm
Sizes (WxDxH) 21 4/16 x 16 15/16 x 18 8/16 "

Peso netto 34 kg - 75 lbs
Net weight

Fusibile 10 A
Fuse

HIKU 26



Produzione 24h* 22 kg - 49 lbs
Production 24h

Capacità contenitore fino a/up to: 7 kg - 15 lbs
Storage Capacity

Condensazione A - W
Cooling system

Tipo di cubetto D-13g
Kind of cube

Consumo elettrico** 250 W
Electrical consumption

Dimensioni (LxPxH) * 395 x 530 x 790 mm
Sizes (WxDxH) 15 9/16 x 20 14/16 x 31 2/16 "

Peso netto 41 kg - 90 lbs
Net weight

Fusibile 10 A
Fuse

IC 24



Produzione 24h* 26 kg - 57 lbs
Production 24h

Capacità contenitore fino a/up to: 6 kg - 13 lbs
Storage Capacity

Condensazione A
Cooling system

Tipo di cubetto A-18g, D-13g
Kind of cube

Consumo elettrico** 350 W
Electrical consumption

Dimensioni (LxPxH) * 595 x 510 x 502 mm
Sizes (WxDxH) 23 7/16 x 20 1/16 x 19 12/16 "

Peso netto 41 kg - 90 lbs
Net weight

Fusibile 10 A
Fuse

DSS 42



Produzione 24h* 44 kg - 97 lbs
Production 24h

Capacità contenitore fino a/up to: 12 kg - 26 lbs
Storage Capacity

Condensazione A - W
Cooling system

Tipo di cubetto D-13g
Kind of cube

Consumo elettrico** 450 W
Electrical consumption

Dimensioni (LxPxH) 500 x 630 x 920 mm
Sizes (WxDxH) 19 11/16 x 24 13/16 x 36 4/16 "

Peso netto 66 kg - 146 lbs
Net weight

Fusibile 10 A
Fuse

Fast Ice



► VB Series



► VM Series



VB 250



Produzione 24h* 105 kg - 231 lbs
Production 24h

Capacità contenitore fino a/up to: 35 kg - 77 lbs
Storage Capacity

Condensazione A - W
Cooling system

Tipo di cubetto 7g
Kind of cube

Consumo elettrico** 850 W
Electrical consumption

Dimensioni (LxPxH) ** 738 x 600 x 980 mm
Sizes (WxDxH) 29 1/16 x 23 10/16 x 38 9/16 "

Peso netto 75 kg - 165 lbs
Net weight

Fusibile 10 A
Fuse

VM 900



Produzione 24h* 400 kg - 882 lbs
Production 24h

Condensazione A - W
Cooling system

Tipo di cubetto 7g
Kind of cube

Consumo elettrico** 3000 W
Electrical consumption

Dimensioni (LxPxH) 770 x 550 x 805 mm
Sizes (WxDxH) 30 5/16 x 21 10/16 x 31 11/16 "

Peso netto 113 kg - 249 lbs
Net weight

Fusibile 32 A
Fuse

Bin utilizzabile Bin 240PE - Bin 200
Usable bin Bin 350 - DRB 100

VM 350



Produzione 24h* 140 kg - 309 lbs
Production 24h

Condensazione A - W
Cooling system

Tipo di cubetto 7g
Kind of cube

Consumo elettrico** 1400 W
Electrical consumption

Dimensioni (LxPxH) 540 x 544 x 747 mm
Sizes (WxDxH) 21 4/16 x 21 7/16 x 29 7/16 "

Peso netto 73 kg - 161 lbs
Net weight

Fusibile 16 A
Fuse

Bin utilizzabile Bin 110 - Bin 200
Usable bin Bin 240PE

VM 1700



Produzione 24h* 770 kg - 1698 lbs
Production 24h

Condensazione A
Cooling system

Tipo di cubetto 7g
Kind of cube

Consumo elettrico** 4300 W
Electrical consumption

Dimensioni (LxPxH) 1250 x 645 x 950 mm
Sizes (WxDxH) 49 3/16 x 25 6/16 x 37 6/16 "

Peso netto 186 kg - 410 lbs
Net weight

Fusibile 32 A
Fuse

Bin utilizzabile Bin 350
Usable bin

VM 500



Produzione 24h* 200 kg - 441 lbs
Production 24h

Condensazione A - W
Cooling system

Tipo di cubetto 7g
Kind of cube

Consumo elettrico** 1600 W
Electrical consumption

Dimensioni (LxPxH) 770 x 550 x 805 mm
Sizes (WxDxH) 30 5/16 x 21 10/16 x 31 11/16 "

Peso netto 90 kg - 198 lbs
Net weight

Fusibile 20 A
Fuse

Bin utilizzabile Bin 240PE - Bin 200
Usable bin Bin 350 - DRB 100

Ice Finger

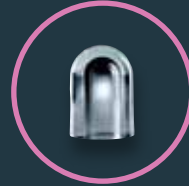

IMF Series



	IMF 26	Produzione 24h* Production 24h	25 kg - 55 lbs
	Capacità contenitore Storage Capacity	fino a/up to: 4 kg - 9 lbs	
	Condensazione Cooling system	A - W	
	Tipo di cubetto Kind of cube	A-20g	
	Consumo elettrico** Electrical consumption	310 W	
	Dimensioni (LxPxH) * Sizes (WxDxH)	385 x 468 x 607 mm 15 3/16 x 18 7/16 x 23 14/16 "	
	Peso netto Net weight	36 kg - 79 lbs	
Fusibile Fuse	10 A		

	IMF 28	Produzione 24h* Production 24h	25 kg - 55 lbs
	Capacità contenitore Storage Capacity	fino a/up to: 8 kg - 18 lbs	
	Condensazione Cooling system	A - W	
	Tipo di cubetto Kind of cube	A-20g	
	Consumo elettrico** Electrical consumption	310 W	
	Dimensioni (LxPxH) * Sizes (WxDxH)	385 x 468 x 687 mm 15 3/16 x 18 7/16 x 27 1/16 "	
	Peso netto Net weight	38 kg - 84 lbs	
Fusibile Fuse	10 A		

	IMF 35	Produzione 24h* Production 24h	35 kg - 77 lbs
	Capacità contenitore Storage Capacity	fino a/up to: 15 kg - 33 lbs	
	Condensazione Cooling system	A - W	
	Tipo di cubetto Kind of cube	A-20g	
	Consumo elettrico** Electrical consumption	310 W	
	Dimensioni (LxPxH) ** Sizes (WxDxH)	495 x 580 x 687 mm 19 8/16 x 22 13/16 x 27 1/16 "	
	Peso netto Net weight	47 kg - 104 lbs	
Fusibile Fuse	10 A		

	IMF 58	Produzione 24h* Production 24h	50 kg - 110 lbs
	Capacità contenitore Storage Capacity	fino a/up to: 20 kg - 44 lbs	
	Condensazione Cooling system	A - W	
	Tipo di cubetto Kind of cube	A-20g	
	Consumo elettrico** Electrical consumption	420 W	
	Dimensioni (LxPxH) ** Sizes (WxDxH)	495 x 580 x 797 mm 19 8/16 x 22 13/16 x 31 6/16 "	
	Peso netto Net weight	54 kg - 119 lbs	
Fusibile Fuse	10 A		

	IMF 80	Produzione 24h* Production 24h	75 kg - 165 lbs
	Capacità contenitore Storage Capacity	fino a/up to: 30 kg - 66 lbs	
	Condensazione Cooling system	A - W	
	Tipo di cubetto Kind of cube	A-20g	
	Consumo elettrico** Electrical consumption	480 W	
	Dimensioni (LxPxH) ** Sizes (WxDxH)	735 x 596 x 907 mm 28 15/16 x 23 7/16 x 35 11/16 "	
	Peso netto Net weight	75 kg - 165 lbs	
Fusibile Fuse	10 A		

Ice Pebbles





TB Series





TM Series





	TB 551	Produzione 24h* Production 24h	55 kg - 121 lbs
	Capacità contenitore Storage Capacity	fino a/up to: 10 kg - 22 lbs	
	Condensazione Cooling system	A - W	
	Dim. pebble mm *** Size pebble mm	8 x 16 x 7	
	Consumo elettrico** Electrical consumption	420 W	
	Dimensioni (LxPxH) * Sizes (WxDxH)	450 x 620 x 680 mm 17 11/16 x 24 7/16 x 26 12/16 "	
	Peso netto Net weight	56 kg - 123 lbs	
Fusibile Fuse	10 A		

	TB 852	Produzione 24h* Production 24h	85 kg - 187 lbs
	Capacità contenitore Storage Capacity	fino a/up to: 20 kg - 44 lbs	
	Condensazione Cooling system	A - W	
	Dim. pebble mm *** Size pebble mm	8 x 16 x 7	
	Consumo elettrico** Electrical consumption	550 W	
	Dimensioni (LxPxH) ** Sizes (WxDxH)	500 x 660 x 690 mm 19 11/16 x 26 x 27 3/16 "	
	Peso netto Net weight	59 kg - 130 lbs	
Fusibile Fuse	10 A		

	TB 1404	Produzione 24h* Production 24h	140 kg - 309 lbs
	Capacità contenitore Storage Capacity	fino a/up to: 40 kg - 88 lbs	
	Condensazione Cooling system	A - W	
	Dim. pebble mm *** Size pebble mm	8 x 16 x 7	
	Consumo elettrico** Electrical consumption	650 W	
	Dimensioni (LxPxH) ** Sizes (WxDxH)	738 x 690 x 851,5 mm 29 1/16 x 27 3/16 x 33 8/16 "	
	Peso netto Net weight	90 kg - 198 lbs	
Fusibile Fuse	10 A		

	TB 1405	Produzione 24h* Production 24h	140 kg - 309 lbs
	Capacità contenitore Storage Capacity	fino a/up to: 50 kg - 110 lbs	
	Condensazione Cooling system	A - W	
	Dim. pebble mm *** Size pebble mm	8 x 16 x 7	
	Consumo elettrico** Electrical consumption	650 W	
	Dimensioni (LxPxH) ** Sizes (WxDxH)	738 x 690 x 1020 mm 29 1/16 x 27 3/16 x 40 3/16 "	
	Peso netto Net weight	94 kg - 207 lbs	
Fusibile Fuse	10 A		

	TM 140	Produzione 24h* Production 24h	140 kg - 309 lbs
	Condensazione Cooling system	A - W	
	Dim. pebble mm *** Size pebble mm	8 x 16 x 7	
	Consumo elettrico** Electrical consumption	650 W	
	Dimensioni (LxPxH) Sizes (WxDxH)	560 x 569 x 600 mm 22 x 22 6/16 x 23 10/16 "	
	Peso netto Net weight	63 kg - 139 lbs	
	Fusibile Fuse	10 A	
Bin utilizzabile Usable bin	Bin 240PE - Bin 110 Bin 200 - RB 100		

	TM 250	Produzione 24h* Production 24h	250 kg - 551 lbs
	Condensazione Cooling system	A - W	
	Dim. pebble mm *** Size pebble mm	13 x 18 x 13	
	Consumo elettrico** Electrical consumption	1050 W	
	Dimensioni (LxPxH) Sizes (WxDxH)	560 x 569 x 695 mm 22 x 22 6/16 x 27 6/16 "	
	Peso netto Net weight	83 kg - 183 lbs	
	Fusibile Fuse	10 A	
Bin utilizzabile Usable bin	Bin 240PE - Bin 110 - Bin 200 Bin 350 - RB 100 - DRB 100		

	TM 450	Produzione 24h* Production 24h	440 kg - 970 lbs
	Condensazione Cooling system	A - W	
	Dim. pebble mm *** Size pebble mm	16,5 x 18 x 11	
	Consumo elettrico** Electrical consumption	1700 W	
	Dimensioni (LxPxH) Sizes (WxDxH)	560 x 569 x 695 mm 22 x 22 6/16 x 27 6/16 "	
	Peso netto Net weight	102 kg - 225 lbs	
	Fusibile Fuse	16 A	
Bin utilizzabile Usable bin	Bin 240PE - Bin 110 - Bin 200 Bin 350 - Bin 550V DS - RB 100 DRB 100 / 500 / 1200		

Ice Flakes



GB Series



G Series

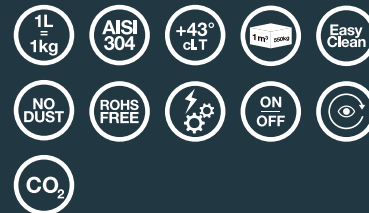

	GB 601	Produzione 24h* Production 24h	60 kg - 132 lbs
	Capacità contenitore Storage Capacity	fino a/up to:	9 kg - 20 lbs
	Condensazione Cooling system	A - W	
	Consumo elettrico** Electrical consumption	420 W	
	Dimensioni (LxPxH) * Sizes (WxDxH)	450 x 620 x 680 mm 17 11/16 x 24 7/16 x 26 12/16 "	
	Peso netto Net weight	56 kg - 123 lbs	
Fusibile Fuse	10 A		

	GB 902	Produzione 24h* Production 24h	95 kg - 209 lbs
	Capacità contenitore Storage Capacity	fino a/up to:	20 kg - 44 lbs
	Condensazione Cooling system	A - W	
	Consumo elettrico** Electrical consumption	550 W	
	Dimensioni (LxPxH) ** Sizes (WxDxH)	500 x 660 x 690 mm 19 11/16 x 26 x 27 3/16 "	
	Peso netto Net weight	59 kg - 130 lbs	
Fusibile Fuse	10 A		

	GB 903	Produzione 24h* Production 24h	95 kg - 209 lbs
	Capacità contenitore Storage Capacity	fino a/up to:	30 kg - 66 lbs
	Condensazione Cooling system	A - W	
	Consumo elettrico** Electrical consumption	550 W	
	Dimensioni (LxPxH) ** Sizes (WxDxH)	500 x 660 x 800 mm 19 11/16 x 26 x 31 8/16 "	
	Peso netto Net weight	67 kg - 148 lbs	
Fusibile Fuse	10 A		

	GB 1540	Produzione 24h* Production 24h	155 kg - 342 lbs
	Capacità contenitore Storage Capacity	fino a/up to:	40 kg - 88 lbs
	Condensazione Cooling system	A - W	
	Consumo elettrico** Electrical consumption	650 W	
	Dimensioni (LxPxH) ** Sizes (WxDxH)	738 x 690 x 920 mm 29 1/16 x 27 3/16 x 36 4/16 "	
	Peso netto Net weight	85 kg - 187 lbs	
Fusibile Fuse	10 A		

	GB 1555	Produzione 24h* Production 24h	155 kg - 342 lbs
	Capacità contenitore Storage Capacity	fino a/up to:	55 kg - 121 lbs
	Condensazione Cooling system	A - W	
	Consumo elettrico** Electrical consumption	650 W	
	Dimensioni (LxPxH) ** Sizes (WxDxH)	738 x 690 x 1020 mm 29 1/16 x 27 3/16 x 40 3/16 "	
	Peso netto Net weight	94 kg - 207 lbs	
Fusibile Fuse	10 A		

	G 160	Produzione 24h* Production 24h	160 kg - 353 lbs
	Condensazione Cooling system	A - W	
	Consumo elettrico** Electrical consumption	650 W	
	Dimensioni (LxPxH) Sizes (WxDxH)	560 x 569 x 600 mm 22 x 22 6/16 x 23 10/16 "	
	Peso netto Net weight	63 kg - 139 lbs	
	Fusibile Fuse	10 A	
Bin utilizzabile Usable bin	Bin 240PE - Bin 110 Bin 200 - RB 100		

	G 280	Produzione 24h* Production 24h	280 kg - 617 lbs
	Condensazione Cooling system	A - W	
	Consumo elettrico** Electrical consumption	1050 W	
	Dimensioni (LxPxH) Sizes (WxDxH)	560 x 569 x 695 mm 22 x 22 6/16 x 27 6/16 "	
	Peso netto Net weight	83 kg - 183 lbs	
	Fusibile Fuse	10 A	
Bin utilizzabile Usable bin	Bin 240PE - Bin 110 Bin 200 - Bin 350 - RB 100 DRB 100		

	G 510	Produzione 24h* Production 24h	510 kg - 1124 lbs
	Condensazione Cooling system	A - W	
	Consumo elettrico** Electrical consumption	1700 W	
	Dimensioni (LxPxH) Sizes (WxDxH)	560 x 569 x 695 mm 22 x 22 6/16 x 27 6/16 "	
	Peso netto Net weight	102 kg - 225 lbs	
	Fusibile Fuse	16 A	
Bin utilizzabile Usable bin	Bin 240PE - Bin 110 Bin 200 - Bin 350 Bin 550V DS - RB 100 DRB 100 / 500 / 1200		

	G 1000	Produzione 24h* Production 24h	1000 kg - 2205 lbs
	Condensazione Cooling system	A - W	
	Consumo elettrico** Electrical consumption	3200 W	
	Dimensioni (LxPxH) Sizes (WxDxH)	934 x 684 x 700 mm 36 12/16 x 26 15/16 x 27 9/16 "	
	Peso netto Net weight	167 kg - 368 lbs	
	Fusibile Fuse	16 A	
Bin utilizzabile Usable bin	Bin 550V DS DRB 500 / 1200		

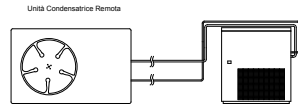
	G 510 Split		Produzione 24h* Production 24h	510 kg - 1124 lbs 720 kg - 1587 lbs
	Potenza frigorifera Cooling capacity		2300W (evap. temp. -18°C) 2300 W (evap. temp. -18°C)	
	Consumo elettrico** Electrical consumption		175 W	
	Dimensioni (LxPxH) Sizes (WxDxH)		560 x 569 x 695 mm 22 x 22 6/16 x 27 6/16 "	
	Peso netto - Net weight		67 kg - 148 lbs	
	Bin utilizzabile Usable bin		Bin 240PE - Bin 110 - Bin 200 - Bin 350 Bin 550V DS - RB 100 - DRB 100 / 500 / 1200	

	G 1000 Split		Produzione 24h* Production 24h	1000 kg - 2205 lbs 1400 kg - 3086 lbs
	Potenza frigorifera Cooling capacity		4600W (evap. temp. -18°C) 4600 W (evap. temp. -18°C)	
	Consumo elettrico** Electrical consumption		350 W	
	Dimensioni (LxPxH) Sizes (WxDxH)		765 x 600 x 695 mm 30 2/16 x 23 10/16 x 27 6/16 "	
	Peso netto - Net weight		118 kg - 260 lbs	
	Bin utilizzabile Usable bin		Bin 550V DS - DRB 500 / 1200	

Ice Scales



Muster Series





Muster 250	Produzione 24h* Production 24h
	250 kg - 551 lbs
Condensazione Cooling system	A - W
Consumo elettrico** Electrical consumption	1700 W
Dimensioni (LxPxH) Sizes (WxDxH)	870 x 550 x 600 mm 34 4/16 x 21 10/16 x 23 10/16 "
Peso netto Net weight	100 kg - 220 lbs
Fusibile Fuse	16 A
Bin utilizzabile Usable bin	Bin 200 - Bin 350

Muster 350	Produzione 24h* Production 24h
	400 kg - 882 lbs
Condensazione Cooling system	A - W
Consumo elettrico** Electrical consumption	2100 W
Dimensioni (LxPxH) Sizes (WxDxH)	900 x 588 x 705 mm 35 7/16 x 23 2/16 x 27 12/16 "
Peso netto Net weight	137 kg - 302 lbs
Fusibile Fuse	16 A
Bin utilizzabile Usable bin	Bin 350 - Bin 550V DS DRB 100

Muster 600	Produzione 24h* Production 24h
	620 kg - 1367 lbs
Condensazione Cooling system	A - W
Consumo elettrico** Electrical consumption	3000 W
Dimensioni (LxPxH) Sizes (WxDxH)	900 x 588 x 705 mm 35 7/16 x 23 2/16 x 27 12/16 "
Peso netto Net weight	151 kg - 333 lbs
Fusibile Fuse	16 A
Bin utilizzabile Usable bin	Bin 350 - Bin 550V DS DRB 100 / 500 / 1200

Muster 800	Produzione 24h* Production 24h
	900 kg - 1984 lbs
Condensazione Cooling system	A - W
Consumo elettrico** Electrical consumption	4600 W
Dimensioni (LxPxH) Sizes (WxDxH)	1107 x 700 x 880 mm 43 9/16 x 27 9/16 x 34 10/16 "
Peso netto Net weight	241 kg - 531 lbs
Fusibile Fuse	16 A
Bin utilizzabile Usable bin	Bin 550V DS DRB 500 / 1200

Muster 1500	Produzione 24h* Production 24h
	1500 kg - 3307 lbs
Condensazione Cooling system	A - W
Consumo elettrico**** Electrical consumption	6000 W
Dimensioni (LxPxH) Sizes (WxDxH)	1107 x 700 x 970 mm 43 9/16 x 27 9/16 x 38 3/16 "
Peso netto Net weight	306 kg - 675 lbs
Fusibile Fuse	32 A
Bin utilizzabile Usable bin	Bin 550V DS DRB 500 / 1200

Muster 2000	Produzione 24h* Production 24h
	2300 kg - 5071 lbs
Condensazione Cooling system	A
Consumo elettrico**** Electrical consumption	7000 W
Dimensioni (LxPxH) Sizes (WxDxH)	1062 x 832 x 1423 mm 41 13/16 x 32 12/16 x 56 "
Peso netto Net weight	520 kg - 1146 lbs
Fusibile Fuse	32 A
Bin utilizzabile Usable bin	-

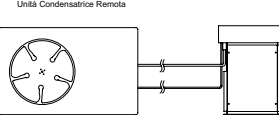
Muster 350 Split	Unità Condensatrice Remota
	
Produzione 24h* Production 24h	400 kg - 882 lbs
Potenza frigorifera Cooling capacity	2200 W (evap. temp. -23°C)
Consumo elettrico** Electrical consumption	180 W
Dimensioni (LxPxH) Sizes (WxDxH)	495 x 588 x 705 mm 19 8/16 x 23 2/16 x 27 12/16 "
Peso netto - Net weight	66 kg - 146 lbs
Bin utilizzabile Usable bin	Bin 350 - Bin 550V DS - DRB 100

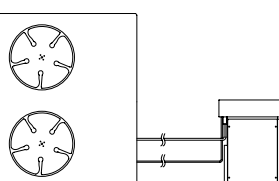
Muster 600 Split	M 600 Split CO ₂
	
Produzione 24h* Production 24h	620 kg - 1367 lbs 620 kg - 1367 lbs
Potenza frigorifera Cooling capacity	3500 W (evap. temp. -22°C) 3500 W (evap. temp. -23°C)
Consumo elettrico** Electrical consumption	180 W
Dimensioni (LxPxH) Sizes (WxDxH)	495 x 588 x 705 mm 19 8/16 x 23 2/16 x 27 12/16 "
Peso netto - Net weight	73 kg - 161 lbs
Bin utilizzabile Usable bin	Bin 350 - Bin 550V DS - DRB 100 / 500 / 1200

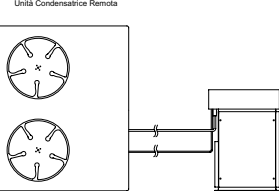
Muster 800 Split	Muster 1000 Split CO ₂
	
Produzione 24h* Production 24h	900 kg - 1984 lbs 1040 kg - 2293 lbs
Potenza frigorifera Cooling capacity	5000 W (evap. temp. -23°C) 5000 W (evap. temp. -23°C)
Consumo elettrico** Electrical consumption	180 W
Dimensioni (LxPxH) Sizes (WxDxH)	604 x 700 x 880 mm 23 12/16 x 27 9/16 x 34 10/16 "
Peso netto - Net weight	138 kg - 304 lbs
Bin utilizzabile Usable bin	Bin 550V DS - DRB 500 / 1200

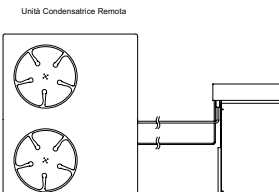
Muster 1500 Split	Muster 1500 Split CO ₂
	
Produzione 24h* Production 24h	1500 kg - 3307 lbs 1520 kg - 3351 lbs
Potenza frigorifera Cooling capacity	8550 W (evap. temp. -24°C) 8550 W (evap. temp. -23°C)
Consumo elettrico** Electrical consumption	180 W
Dimensioni (LxPxH) Sizes (WxDxH)	604 x 700 x 970 mm 23 12/16 x 27 9/16 x 38 3/16 "
Peso netto - Net weight	144 kg - 317 lbs
Bin utilizzabile Usable bin	Bin 550V DS - DRB 500 / 1200

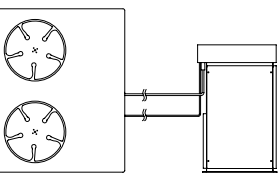
Muster 2000 Split	Unità Condensatrice Remota
	
Produzione 24h* Production 24h	2200 kg - 4850 lbs
Potenza frigorifera Cooling capacity	12000 W (evap. temp. -27°C)
Consumo elettrico** Electrical consumption	180 W
Dimensioni (LxPxH) Sizes (WxDxH)	736 x 832 x 1075 mm 29 x 32 12/16 x 42 5/16 "
Peso netto - Net weight	300 kg - 661 lbs
Bin utilizzabile Usable bin	-



Ice Bin

Bin Series



	ID 70	Capacità contenitore Storage Capacity	18-21 kg - 40-46 lbs
	Tipo di cubetto Kind of cube	7g, 13 x 18 x 13***	
	Consumo el. Electrical consumption	240 W	
	Dimensioni (LxPxH) Sizes (WxDxH)	568 x 799 x 817 mm 22 6/16 x 31 7/16 x 32 3/16"	
	Peso netto Net weight	58 kg - 128 lbs	
Utilizzabile con Usable with		VM 350 - TM 250	

	Bin 240 PE	Capacità contenitore Storage Capacity	180 kg - 397 lbs
	Dimensioni (LxPxH)*** Sizes (WxDxH)	942 x 795 x 1053 mm 37 1/16 x 31 5/16 x 41 7/16"	
	Peso netto Net weight	61 kg - 134 lbs	
	Utilizzabile con Usable with	C 150 - VM 350/500/900 G 160/280/510/510 Split G 700 Split CO ₂ TM 140/250/450	

	Bin 110	Capacità contenitore Storage Capacity	100 kg - 220 lbs
	Dimensioni (LxPxH)*** Sizes (WxDxH)	560 x 815 x 1000 mm 22 x 32 1/16 x 39 6/16"	
	Peso netto Net weight	53 kg - 117 lbs	
	Utilizzabile con Usable with	VM 350 G 160/280/510 G 510 Split/700 Split CO ₂ TM 140/250/450	

	Bin 200	Capacità contenitore Storage Capacity	200 kg - 441 lbs
	Dimensioni (LxPxH)*** Sizes (WxDxH)	870 x 790 x 1000 mm 34 4/16 x 31 2/16 x 39 6/16"	
	Peso netto Net weight	74 kg - 163 lbs	
	Utilizzabile con Usable with	C 150 VM 350/500/900 G 160/280/510/510 Split G 700 Split CO ₂ TM 140/250/450 M 250	

	Bin 350	Capacità contenitore Storage Capacity	350 kg - 772 lbs
	Dimensioni (LxPxH)*** Sizes (WxDxH)	1250 x 790 x 1000 mm 49 3/16 x 31 2/16 x 39 6/16"	
	Peso netto Net weight	105 kg - 231 lbs	
	Utilizzabile con Usable with	C 150/300/300 Split VM 500/900/1700 G 160/280/510/510 Split G 700 Split CO ₂ TM 140/250/450 M 250/350/600 M 350 Split/600 Split M 600 Split CO ₂	

	Bin 550 V DS	Capacità contenitore Storage Capacity	550 kg - 1213 lbs
	Dimensioni (LxPxH)*** Sizes (WxDxH)	1110 x 1060 x 1915 mm 43 11/16 x 41 12/16 x 75 6/16"	
	Peso netto Net weight	163 kg - 359 lbs	
	Utilizzabile con Usable with	G 510/510 Split G 700 Split CO ₂ /1000 G 1000 Split/1400 Split CO ₂ TM 450 M 600/800/1500/600 Split M 600 Split CO ₂ /800 Split M 1000 Split CO ₂ M 1500 Split/1500 Split CO ₂	

	RB 100	Capacità carrello Cart capacity	108 kg - 238 lbs
	Capacità riserva Bay store capacity	17 kg - 37 lbs	
	Dimensioni (LxPxH) Sizes (WxDxH)	795 x 1060 x 1284 mm 31 5/16 x 41 12/16 x 50 9/16"	
	Peso netto Net weight	64 kg - 141 lbs	
	Utilizzabile con Usable with	G160/280/510/510 Split G700 Split CO ₂ TM 140/250/450	

	DRB 100	Capacità carrello Cart capacity	108 x 2 kg - 238 x 2 lbs
	Capacità riserva Bay store capacity	50 kg - 110 lbs	
	Dimensioni (LxPxH) Sizes (WxDxH)	1560 x 1060 x 1484 mm 61 7/16 x 41 12/16 x 58 7/16"	
	Peso netto Net weight	135 kg - 298 lbs	
	Utilizzabile con Usable with	VM 500/900 G 280/510 G 510 Split/700 Split CO ₂ TM 250/450 M 350/600 M 350 Split/600 Split M 600 Split CO ₂	

	DRB 500	Capacità carrello Cart capacity	108 x 2 kg - 238 x 2 lbs
	Capacità riserva Bay store capacity	300 kg - 661 lbs	
	Dimensioni (LxPxH) Sizes (WxDxH)	1560 x 1330 x 1780 mm 61 7/16 x 52 6/16 x 70 1/16"	
	Peso netto Net weight	204 kg - 450 lbs	
	Utilizzabile con Usable with	G 510/510 Split G 700 Split CO ₂ /1000 G 1000 Split/1400 Split CO ₂ TM 450 M 600/800/1500/600 Split M 600 Split CO ₂ /800 Split M 1000 Split CO ₂ M 1500 Split/1500 Split CO ₂	

	DRB 1200	Capacità carrello Cart capacity	108 x 2 kg - 238 x 2 lbs
	Capacità riserva Bay store capacity	1000 kg - 2205 lbs	
	Dimensioni (LxPxH) Sizes (WxDxH)	1560 x 1330 x 2460 mm 61 7/16 x 52 6/16 x 96 14/16"	
	Peso netto Net weight	251 kg - 553 lbs	
	Utilizzabile con Usable with	G 510/510 Split G 700 Split CO ₂ /1000 G 1000 Split/1400 Split CO ₂ TM 450 M 600/800/1500/600 Split M 600 Split CO ₂ /800 Split M 1000 Split CO ₂ M 1500 Split/1500 Split CO ₂	

*** Misure indicative / Approximate size *** Piedino regolabile / Adjustable foot 100-160 mm

Legenda delle icone List of icons



Disponibile per CO₂
CO₂ application



Funzionamento elettromeccanico
Electromechanical operation



Sprayer System
Technology



RoHS Free



Interruttore ON/OFF
ON/OFF rocker switch



Vertical System
Technology



Carrozzeria AISI 304
Scotch Brite
AISI 304 SS Scotch
Brite finishing



Sistema di lavaggio automatico
Automatic washing system



Paddle System
Technology



Classe Tropicale +43°C
Tropical class +43°C



1L (acqua) = 1kg (ghiaccio) - solo A
1l (water) - 1kg (ice) - only Air cooled



Pebbles System
Technology



Filtro Aria smontabile e pulibile
Removable and cleanable air filter



Bacinella acqua sigillata antipolvere
Dust-proof water basin



Granular System
Technology



Filtro anticalcare ispezionabile
Cleanable antiscaling filter



Sensore di rotazione sull'albero lento
Rotation sensor on low speed shaft



Scale System
Technology



Superfici interne arrotondate per pulizia
Easy cleanable internal rounded surfaces



Resa al m³ = 550 kg di ghiaccio
Specific volume 1 m³ = 550 kg of ice



Isolamento contenitore HCFC-Free
HCFC-Free insulated storage



Resa al m³ = 430 kg di ghiaccio
Specific volume 1 m³ = 430 kg of ice

Tipologie di cubetto Kind of cube

Ice Cube

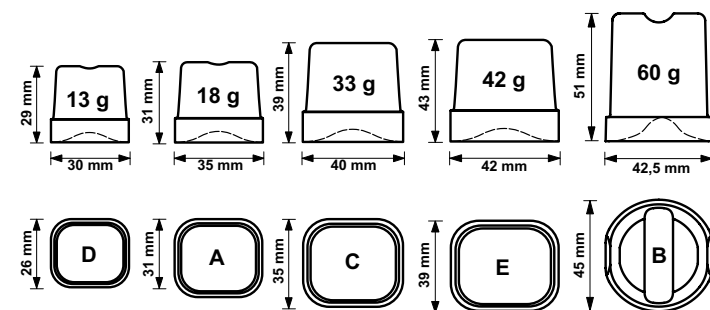

Fast Ice

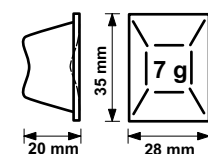

Ice Finger

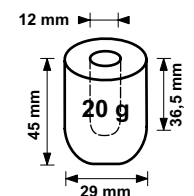

Ice Pebbles

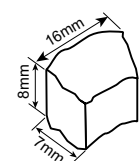

TM 140 - TB Series

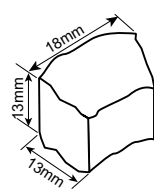

TM 250

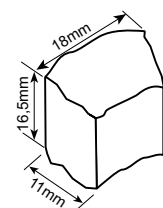

TM 450

Misure approssimative / Approximative size

Rev. 01 - Issued January 2016

I modelli ed i dati riportati possono essere soggetti a modifiche senza preavviso da parte di BREMA Ice Makers.

Models and specifications listed in this catalogue could be subject to change without prior notice by BREMA Ice Makers



Brema Ice Makers S.p.A.

Via dell'industria 10
20020, Villa Cortese (MI), Italy

tel +39 0331 434811
fax +39 0331 433833

info@bremaice.it
www.bremaice.it

