

Read the operating instructions prior to commissioning

Operating instructions

## Combisteamer

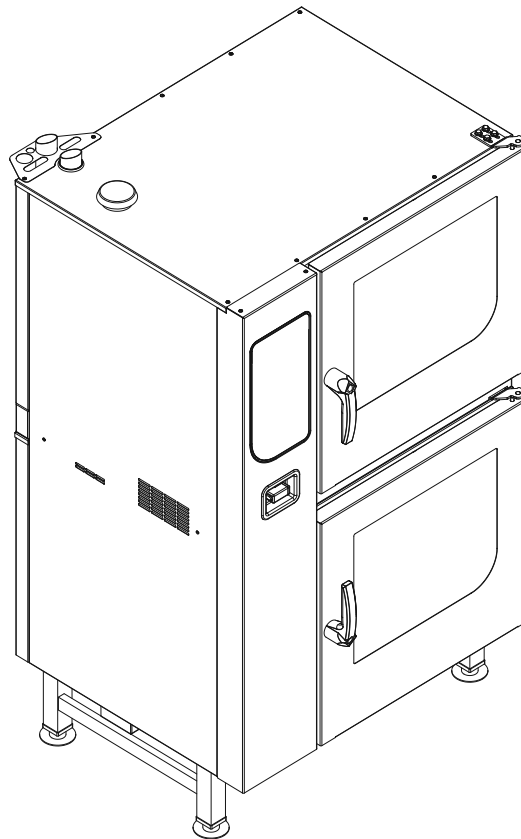

Translation from the original document • 10016528-0ABBE-J • 23/05/2023

Unit	Model	Energy type	Design
FlexiCombi Team	DKECOD615-615 DKECOD615-621 DKECOD621-615 DKECOD621-621 DKECOD115-615 DKECOD115-621 DKECOD121-615 DKECOD121-621 DKECOD615-115 DKECOD621-115 DKECOD615-121 DKECOD621-121	Electric	WaveClean 4-point core temperature sensor (optional) Software version 1.86

## Operating and display elements

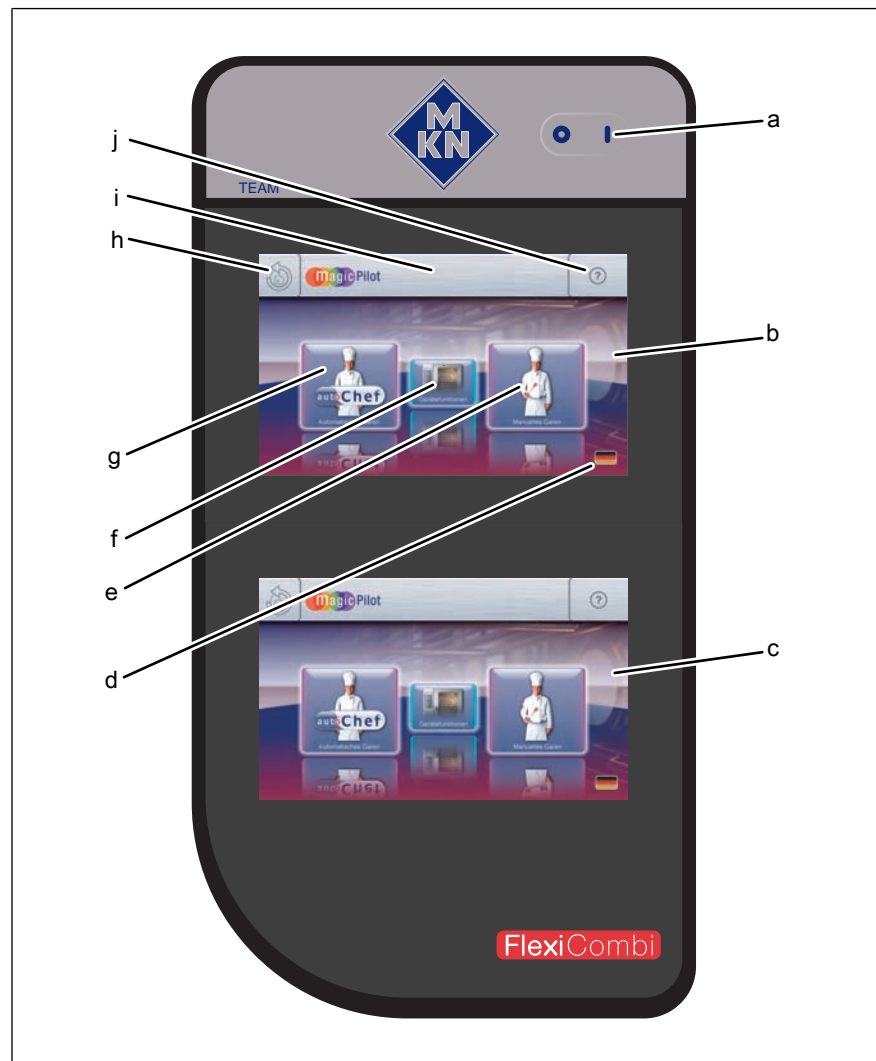

- |   |  |   |                              |
|---|--|---|------------------------------|
| a | <i>On Off</i> button                                       | f | "Equipment functions" button |
| b | Operating element with touchscreen for top Combisteamer    | g | "Automatic cooking" button   |
| c | Operating element with touchscreen for bottom Combisteamer | h | <i>Back</i> button           |
| d | <i>Language selection</i> button                           | i | Information bar              |
| e | "Manual cooking" button                                    | j | <i>FlexiHelp</i> button      |

## **Manufacturer**

MKN Maschinenfabrik Kurt Neubauer GmbH & Co. KG  
Halberstädter Straße 2a  
38300 Wolfenbüttel  
Germany

Phone +49 5331 89-0  
Fax +49 5331 89-280  
Internet [www.mkn.com](http://www.mkn.com)

## **Copyright**

All rights to text, graphics and pictures in this documentation are held by MKN Maschinenfabrik Kurt Neubauer GmbH & Co. KG. Distribution or duplication is only permitted with the prior written consent of MKN.

Copyright by MKN Maschinenfabrik Kurt Neubauer GmbH & Co. KG.



<b>1 Introduction</b>	<b>9</b>
<b>1.1 About this manual</b>	<b>9</b>
1.1.1 Explanation of signs	10
<b>1.2 Intended use</b>	<b>11</b>
<b>1.3 Warranty</b>	<b>11</b>
<b>2 Safety information</b>	<b>12</b>
<b>3 Description of the unit</b>	<b>15</b>
<b>3.1 Overview of the unit</b>	<b>15</b>
<b>3.2 Features</b>	<b>16</b>
3.2.1 Characteristics	16
3.2.2 USB port	16
3.2.3 HACCP logging	16
3.2.4 VideoAssist	16
3.2.5 WaveClean automatic cleaning	16
3.2.6 CombiDoctor (self-diagnostic program)	16
<b>3.3 Operating and cooking modes</b>	<b>17</b>
3.3.1 Operating modes	17
3.3.2 Types of cooking	17
3.3.3 Expanded cooking functions	18
3.3.4 Core temperature measurement	21
<b>3.4 MagicPilot equipment controls</b>	<b>21</b>
<b>3.5 Loading capacity</b>	<b>23</b>
3.5.1 Plate capacity during regeneration	23
3.5.2 Loading capacity	23
<b>3.6 Standard setting values</b>	<b>24</b>
3.6.1 Core temperature standard setting	24
3.6.2 Temperature standard setting	24
3.6.3 Cooking zone humidity standard setting	24
<b>4 Operating the unit</b>	<b>25</b>
<b>4.1 Operating the unit in an environmentally responsible manner</b>	<b>25</b>
<b>4.2 Switching the unit on and off</b>	<b>26</b>
4.2.1 Switching on	26
4.2.2 Switching off	26
<b>4.3 Opening and closing the cooking zone door</b>	<b>26</b>
4.3.1 Opening the single-stage door latch	26
4.3.2 Closing the single stage door latch	27
4.3.3 Opening the 2-stage door lock	27
4.3.4 Closing the 2-stage door lock	28
<b>4.4 Loading and emptying the unit</b>	<b>28</b>
4.4.1 Loading and emptying	28

<b>4.5 Equipment functions menu</b> .....	<b>29</b>
4.5.1 Opening the equipment functions menu .....	29
4.5.2 Changing the basic settings .....	30
4.5.3 Retrieving equipment information .....	32
4.5.4 Setting the date and time .....	32
4.5.5 Presetting the language selection .....	33
4.5.6 Setting favourites .....	34
4.5.7 Activating and cancelling inhibit operation .....	34
4.5.8 Setting the background lighting .....	35
4.5.9 Setting the water filter maintenance .....	36
4.5.10 Possible settings in the parameter level .....	36
4.5.11 Importing video .....	38
4.5.12 Importing images .....	39
4.5.13 Importing recipes .....	40
<b>4.6 Basic functions</b> .....	<b>41</b>
4.6.1 Setting the cooking temperature .....	41
4.6.2 Setting the cooking time and continuous operation .....	42
4.6.3 Setting the core temperature .....	44
4.6.4 Setting the fan speed and direction of rotation .....	45
4.6.5 Using Perfection (regeneration) .....	46
4.6.6 Using PerfectHold .....	47
4.6.7 Setting Ready2Cook .....	48
4.6.8 Using start-time preselection .....	49
4.6.9 Using Steam Exhaust System (SES) .....	51
4.6.10 HoodIn .....	52
4.6.11 Using RackControl2 .....	52
4.6.12 Using FamilyMix .....	55
4.6.13 Using the Continue cooking function .....	56
4.6.14 Setting manual humidification .....	58
4.6.15 Setting the rest stage .....	59
4.6.16 Using QualityControl .....	60
4.6.17 Using low-temperature cooking .....	61
4.6.18 Using Delta-T cooking .....	62
4.6.19 Inserting and removing a USB flash drive .....	63
4.6.20 Exporting the HACCP log .....	64
<b>4.7 Using the core temperature sensor</b> .....	<b>65</b>
4.7.1 Measuring with a 4-point core temperature sensor .....	65
4.7.2 Measuring with a sous-vide core temperature sensor .....	66
4.7.3 Measuring the core temperature when cooking frozen food .....	66
4.7.4 Core temperature display with time-controlled cooking process .....	67
4.7.5 Core temperature display outside the cooking process .....	67
<b>4.8 Manual cooking</b> .....	<b>68</b>
4.8.1 Opening the Manual cooking menu .....	68
4.8.2 Creating a cooking program step .....	68

<b>4.9 Creating and managing your own cooking programs</b> .....	<b>71</b>
4.9.1 Creating a cooking program .....	71
4.9.2 Saving the cooking program .....	73
4.9.3 Exporting a cooking program .....	77
<b>4.10 Automatic cooking (autoChef)</b> .....	<b>77</b>
4.10.1 Opening the Automatic cooking menu .....	78
4.10.2 Finding and opening a cooking program .....	78
4.10.3 Starting the cooking program .....	79
4.10.4 Ending the cooking program .....	80
4.10.5 Modifying the cooking program .....	80
4.10.6 Deleting a cooking program .....	82
4.10.7 Exporting and importing a cooking program .....	83
<b>4.11 VideoAssist</b> .....	<b>85</b>
4.11.1 Watching a video .....	85
4.11.2 Deleting a video .....	85
<b>4.12 Pausing and finishing use</b> .....	<b>86</b>
4.12.1 Perform a hygiene flush after an extended period of idleness .....	86
<b>5 Cleaning and caring for the unit</b> .....	<b>87</b>
<b>5.1 Preventing corrosion</b> .....	<b>88</b>
<b>5.2 Remove rust spots</b> .....	<b>88</b>
<b>5.3 Cleaning the housing</b> .....	<b>88</b>
<b>5.4 Cleaning the handle, operating elements and operating panel membrane</b> .....	<b>89</b>
<b>5.5 Cleaning the touchscreen</b> .....	<b>89</b>
<b>5.6 Cleaning the door seal</b> .....	<b>90</b>
<b>5.7 Cleaning the cooking zone door</b> .....	<b>90</b>
<b>5.8 Cleaning the steam outlet</b> .....	<b>91</b>
<b>5.9 Cleaning the condensation hood (optional)</b> .....	<b>91</b>
<b>5.10 Removing calcium deposits from the unit</b> .....	<b>92</b>
<b>5.11 Cleaning the cooking zone automatically with WaveClean</b> ....	<b>92</b>
5.11.1 Preparing for cleaning .....	93
5.11.2 Selecting the cleaning level .....	94
5.11.3 Inserting the cleaning cartridge .....	94
5.11.4 Starting automatic cleaning .....	95
5.11.5 Cancelling automatic cleaning .....	95
5.11.6 Ending automatic cleaning .....	96
<b>5.12 Cleaning the cooking zone manually</b> .....	<b>96</b>
5.12.1 Preparing the cooking zone .....	96
5.12.2 Starting the cleaning program .....	96
5.12.3 Spraying the cleaner .....	97
5.12.4 Allowing the cleaner to act .....	97
5.12.5 Starting cleaning .....	97
5.12.6 Rinsing the cooking zone .....	97

5.12.7 Drying the cooking zone .....	98
<b>5.13 Swinging the air diverter open and closed .....</b>	<b>98</b>
<b>5.14 Inspecting the unit .....</b>	<b>99</b>
5.14.1 Performing a visual inspection .....	99
5.14.2 Running CombiDoctor (self-diagnostic program) .....	100
<b>6 Transporting the unit .....</b>	<b>101</b>
<b>7 Troubleshooting .....</b>	<b>102</b>
7.1 Emergency mode .....	102
7.2 Causes of errors and remedies .....	103
7.3 Nameplate .....	103
<b>8 Carrying out maintenance .....</b>	<b>104</b>
<b>9 Dispose of unit in an environmentally responsible manner .....</b>	<b>105</b>
<b>10 Manufacturer's declaration .....</b>	<b>106</b>
<b>Keyword index .....</b>	<b>109</b>





# 1 Introduction

## 1.1 About this manual

The operating instructions are part of the unit and contain information:

- On safe operation,
- On cleaning and care,
- On remedies in case of faults.

Be aware of the following notes and adhere to them:

- Read the operating instructions completely before operating the unit for the first time.
- Make the operating instructions available to the operator at all times at the operating site of the unit.
- Insert any supplements from the manufacturer.
- Keep the operating instructions throughout the service life of the unit.
- Pass on the operating instructions to any subsequent operator of the unit.

**Target group** The target group of the instruction manual is the operator, who is entrusted with the operation, cleaning and care of the unit.

**Figures** All figures in this manual are intended as examples. Discrepancies between these and the actual unit can arise.

## 1.1.1 Explanation of signs



**DANGER**  
**Imminent threat of danger**

Failure to comply will lead to death or very severe injuries.

---



**WARNING**  
**Possible threat of danger**

Failure to comply can lead to death or very severe injuries.

---



**CAUTION**  
**Dangerous situation**

Failure to comply can lead to slight or moderately severe injuries.

---

**ATTENTION**  
**Physical damage**

Failure to comply can cause physical damage.

---



Notes for better understanding and operation of the unit.

---

Symbol / sign	Meaning
•	Listing of information.
→	Action steps, which can be performed in any sequence.
1. 2.	Action steps, which must be performed in the specified sequence.
↳	Result of an action performed or additional information about it.

## 1.2 Intended use

This unit is intended to be used solely for commercial purposes, particularly in commercial kitchens.

This unit may only be used with suitable accessories and for the cooking of food.

**It is forbidden to use the unit for purposes, which include the following:**

- Washing dishes
- Storing supplies
- Drying cloths, paper or dishes
- Heating acids, alkaline solutions or other chemicals
- Heating preserved food
- Heating flammable liquids
- Heating rooms
- Cleaning air filters

**The use of the unit is prohibited in the following countries:**

- USA
- Canada

## 1.3 Warranty

The warranty is void and safety is no longer assured in the event of:

- Improper conversion or technical modifications of the unit,
- Improper use,
- Incorrect startup, operation or maintenance of the unit,
- Problems resulting from failure to observe these instructions.

## 2 Safety information

The unit complies with applicable safety standards. Residual risks associated with operation or risks resulting from incorrect operation cannot be ruled out and are mentioned specifically in the safety instructions and warnings.

The operator must be familiar with regional regulations and observe them.

**Operation** During operation, the following group of individuals must be supervised by an individual who is responsible for safety:

- Individuals with physical, sensory, or mental handicaps, or who lack the knowledge and experience to operate the unit properly.

The supervising individual must be familiar with the unit and the risks associated with it.

Do not allow children to operate, clean or play with the appliance.

**Hot surfaces Risk of burns from hot surfaces**

- Protect arms and hands by wearing suitable protective gloves.
- Allow surfaces to cool prior to cleaning.
- Remove hot cookware only with suitable protective gloves or potholders.
- Remove containers and baking sheets only with suitable protective gloves or potholders.

**Hot liquids Risk of burns from hot liquids**

- Protect arms and hands by wearing suitable protective gloves.
- Remove, transport and empty containers carefully.

**Risk of chemical burns from evaporating cleaners**

- Follow the instructions of the cleaning agent manufacturer.
- Allow the cooking so to clean to a temperature below 60 °C and then clean.

**Risk of burns from steam**

- Protect arms and hands by wearing protective gloves.
- Do not hold hands in front of the extractor hood.
- First open the cooking zone door slightly and allow the steam to escape. Then open the cooking zone door completely.
- Dry unit completely after cleaning it.
- Only open the bottom cooking zone door, if there are no functions being carried out in the top cooking zone.

**Defective unit Risk of injury from a defective unit**

- Disconnect a defective unit from the electric mains.
- Do not operate a defective unit.
- Allow only an authorized technician to repair the unit.

**Fire prevention Risk of fire from dirt and grease deposits**

- Clean the unit when finished using it.
- Do not use the unit as a deep fat fryer.
- Clean the cooking zone regularly and remove any fat deposits.

**Risk of fire from overheating**

- Do not store any combustible objects or plastic containers in the cooking zone.

**Firefighting**

- In the event of a fire, disconnect the unit from the electric mains.
- Use a Fire Class F fire extinguisher, never water, to extinguish grease fires. Other fires, for instance, can be extinguished with fire extinguishers suitable for Fire Classes A, B, C, CO<sub>2</sub> fire extinguishers or extinguishing media suitable for the fire class confronted.

**Unit on casters Risk of injury from a unit on casters**

- Lock casters during operation.
- Only move an empty unit.

**Risk of a line breaking if subjected to high tensile load**

- Secure the unit to the building with a chain for strain relief on the connection lines, so that there is no stress on the connection lines, if the unit moves. The strain relief must be designed for a tensile load of at least 0.6 kN.

**Improper cleaning Risk of chemical burns from cleaning agent**

- Follow the instructions of the cleaning agent manufacturer.
- Take appropriate protective measures when handling aggressive cleaning agents.

**Risk of falling on smooth or slippery floor**

- Keep the floor in front of the unit clean and dry.

**Risk of injury from improper cleaning**

- Clean the cooking zone carefully. The cooking zone sensor protrudes into the cooking zone.

### **Risk of physical damage from improper cleaning**

- Clean the unit after using it.
- Do not clean the unit with a high-pressure cleaner or water jet.
- Do not clean the housing with highly abrasive or chemically aggressive cleaning agents.
- Do not clean the housing with highly abrasive sponges.
- Follow the instructions of the cleaning agent manufacturer.
- Do not cool shock the unit by cooling it abruptly.
- Clean the cooking zone carefully. The cooking zone sensor protrudes into the cooking zone.
- Do not use any bleaching or chlorine-containing cleaners or disinfectants.
- Remove rust spots with an abrasive.
- Keep the unit free of calcium deposits.

### **Hygiene Health risk from insufficient hygiene**

- Observe applicable regional hygiene regulations.

### **Core temperature measurement Risk of injury from overheated core temperature sensor**

- Do not heat the core temperature sensor over an open flame.

### **Improper use Risk of physical damage from improper use**

- Use only original accessories.
- Train operators regularly.
- Do not heat food warmer plates or tins of preserved food.
- Do not cover air inlet and outlet openings.
- Do not operate the unit at temperatures below 4° C.
- Remove the core temperature sensor before the cooked food is removed.
- Insert the core temperature sensor back into the holder after use.

### 3 Description of the unit

The unit is a convection steamer, which is suitable for most cooking methods used in commercial kitchens. It can be used with either Convection or unpressurised live steam, either individually, in sequence, or in conjunction with moist or dry heat.

#### 3.1 Overview of the unit

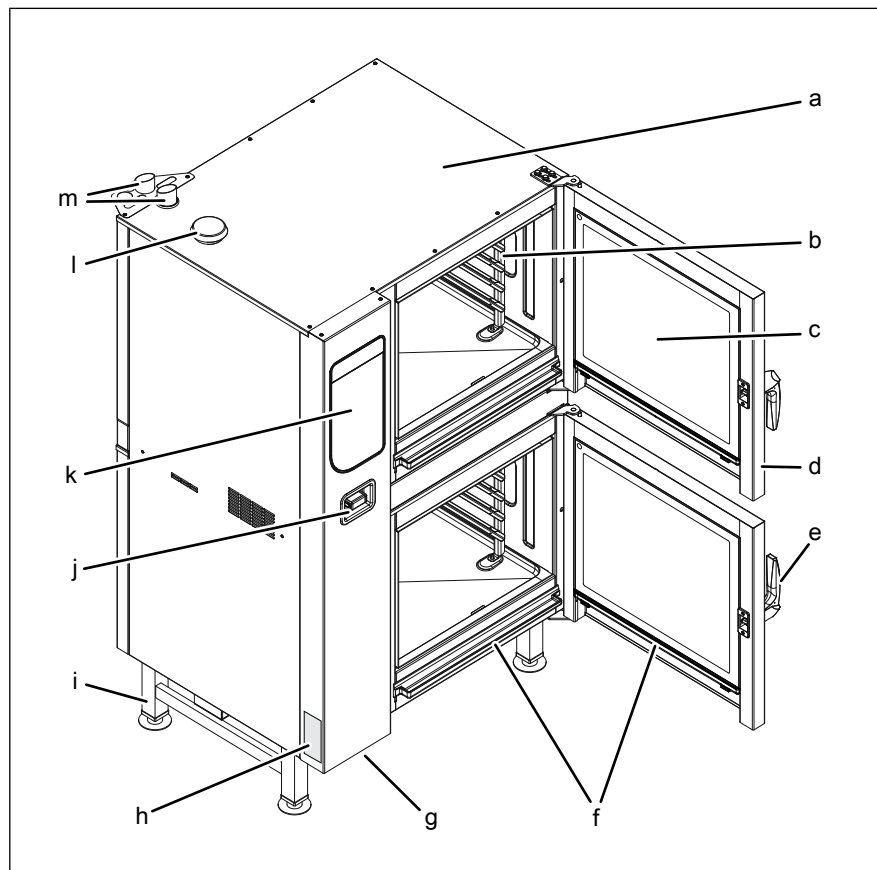

Image: Floor-standing unit

- |   |                     |   |               |
|---|---------------------|---|---------------|
| a | Housing             | h | Nameplate     |
| b | Support rack        | i | Equipment leg |
| c | Insulated window    | j | Hand shower   |
| d | Cooking zone door   | k | Control unit  |
| e | Door handle         | l | Air inlet     |
| f | Steam drain channel | m | Steam outlet  |
| g | USB port (covered)  |   |               |

### 3.2 Features

#### 3.2.1 Characteristics

- Two cooking zones that can be used independently of each other
- Two 4-point core temperature sensors
- A hand shower with sufficient hose length for both cooking zones
- Two cooking zone doors with hygiene glazing
- 1-stage door lock
- 2-stage door lock (optional)
- Power optimisation system (optional)
- Ethernet connection (optional)
- Cooking zone doors hinged on the right
- WaveClean
- Steam Exhaust System (SES)

#### 3.2.2 USB port

The unit is equipped with a USB port (USB 2.0).

HACCP logs can be exported via the USB port.

A wireless or corded barcode scanner (optional) can be connected to the USB port.



---

The USB port on the left is for the top Combisteamer; the USB port on the right is for the bottom Combisteamer.

---

#### 3.2.3 HACCP logging

All cooling programs run are recorded in the HACCP log.

The data are exported via the USB port.

#### 3.2.4 VideoAssist

VideoAssist can be used to display videos with additional explanations regarding operation.

#### 3.2.5 WaveClean automatic cleaning

With WaveClean automatic cleaning, the cooking zone is cleaned with the aid of a cleaning cartridge intended specifically for the program and then rinsed clean.

#### 3.2.6 CombiDoctor (self-diagnostic program)

CombiDoctor uses a selectable self-diagnostic program to check the components used for climate control and cleaning.



### 3.3 Operating and cooking modes

#### 3.3.1 Operating modes



##### Manual cooking

In the Manual cooking mode, individual cooking modes and equipment functions can be activated directly. The various cooking modes and equipment functions can be modified individually.



##### Automatic cooking (autoChef)

In the Automatic cooking mode, saved cooking programs can be activated and modified if necessary.

#### 3.3.2 Types of cooking



##### Steaming

Steaming is a cooking mode, in which the food to be cooked is cooked gently by means of steam in a temperature range of 30 °C to 130 °C.



##### Combisteaming

Combisteaming is a cooking mode, in which the Steaming and Convection cooking modes are combined. The temperature range extends from 30 °C to 250 °C.

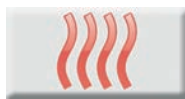

##### Convection

Convection is a cooking mode, in which the food to be cooked is cooked without additional moisture in a temperature range of 30 °C to 300 °C.



##### Perfection (regeneration)

Perfection is a cooking mode that can be used to prepare cooled cooked food quickly in a temperature range of 30 °C to 180 °C and then keep it warm.



##### Delta-T cooking

Delta-T cooking is a cooking mode, in which the cooking temperature depends on the core temperature of the food being cooked.



The cooking temperature is always higher than the current core temperature by the set value (Delta-T value, cooking temperature difference). The resulting cooking time is longer than with other cooking modes.



Delta-T cooking is particularly well-suited for gentle cooking. The food being cooked remains tender and juicy with little weight loss.



### Low-temperature cooking

Low-temperature cooking is a cooking mode where the food to be cooked is cooked in an especially gentle manner in a temperature range of 30 °C to 100 °C.

The cooking time is considerably longer than at higher temperatures, but no supervision is required and the cooking time can be extended considerably without any loss in quality.

The food being cooked remains tender and juicy with little weight loss.



### Baking

Baking is a cooking mode, in which the texture of the food to be cooked is loosened and then cooked and browned by Convection in a temperature range of 30 °C to 220 °C. Before baking takes place, a humidifying process with its associated acting time can be performed.

### 3.3.3 Expanded cooking functions

Expanded cooking functions can be used to modify individual cooking steps for the particular food being cooked.

The following expanded cooking functions are available:



### PerfectHOLD

PerfectHOLD is a cooking function, in which the food to be cooked is kept warm in the unit at a temperature range of 50 °C to 100 °C after the actual cooking process, until it is ready to be served.



### Ready2Cook (preheating)

For many cooking programs such as baking for example, the correct starting temperature is important.

With Ready2Cook, the cooking zone can automatically be heated or cooled to the correct starting temperature.

A screen-filling display gives information during the procedure about the status.



### Start-time preselection



When using the start time delay, temperatures that promote the growth of harmful microorganisms on the food being cooked can occur in the cooking zone. Observe food processing regulations.

Start-time preselection allows a waiting period to be set until the program starts.

In this way, bottlenecks in production and preparation can be avoided.

The prepared food to be cooked can be loaded into the unit and the desired cooking program selected.



### Steam Exhaust System (SES)

This function is activated as standard for all cooking programs that have a cooking time longer than 6 minutes.

The Steam Exhaust System (SES) is activated automatically shortly before the end of cooking.

After the cooking time has elapsed, the Steam Exhaust System (SES) extracts the steam from the cooking zone. It is then possible to open the cooking zone door without risk of injury.



### RackControl2

RackControl is ideal for rolling cooking.

With the extended RackControl2 cooking function, different foods such as potatoes, cauliflower, peas, carrots and meat can be cooked simultaneously for different times.

RackControl2 monitors the various cooking times in one process. When a cooking time has elapsed, a signal sounds and the food being cooked can be removed.

The set temperature can be changed during an active cooking process, without the process having to be stopped.



### ChefsHelp

The extended ChefsHelp cooking function allows a cooking step to be inserted, which at a certain time gives the user further help information through text and images.



### FlexiRack

The extended FlexiRack cooking function enables a cooking program to be set individually for each rack.



### FamilyMix

With the extended FamilyMix cooking function, the appropriate cooking programs for the currently set cooking mode are displayed from the *Automatic cooking (autoChef)* menu. The cooking programs displayed have the same cooking climate and an identical or shorter cooking time. Tapping the individual suggestions transfers the cooking times for the particular products to the RackControl function, and these can then be started during cooking when desired.



### Manual humidification

The extended Manual humidification cooking function allows the cooking humidity to be increased during operation.

Manual humidification can only be used in the Convection and Delta-T Convection cooking modes.

The remaining time for this procedure is displayed during humidification. After the Drop symbol has been touched, the set value is displayed for 3 seconds.



### Resting time

With the extended Resting time cooking function, a cooking step can be inserted during which the heating and the fan are programmed to switch off for a certain period of time.



### QualityControl

The extended QualityControl cooking function enables the control system to detect by itself the loading volume and to adjust the particular cooking parameters in autoChef. This ensures that there is always first-class quality.

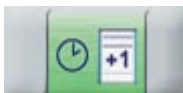

### After-cooking button

The After-cooking button allows the cooking process to continue for a previously defined time, after the cooking program has elapsed.

### Time2Serve



Using the extended Time2Serve cooking function, different products can be ready to serve at the same time.

The serving time is specified. The Combisteamer gives a message, when a remaining cooking time for a product is reached. A signal sounds and the food to be cooked is loaded in succession during an active cooking process. The cooking time is reduced and resources saved.



### ClimaSelect plus

The extended ClimaSelect plus cooking function optimises the climate in the cooking zone. Steam is introduced in small stages, and the climate can be controlled individually.

### 3.3.4 Core temperature measurement

When using core temperature measurement, the temperature inside the food being cooked is measured by means of a core temperature sensor.

As soon as the target core temperature is reached, the cooking process is ended automatically or, in the case of a multi-step cooking process, the next cooking step starts.

The use of core temperature measurement offers the following benefits:

- Reduced energy and water consumption
- No overcooking
- Less weight lost by the food being cooked
- High HACCP safety

### 3.4 MagicPilot equipment controls

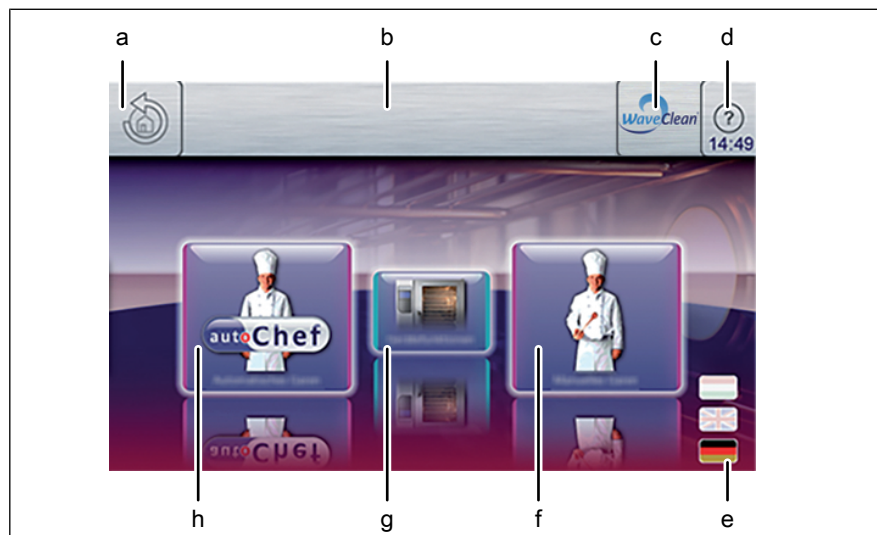

Image: Main menu

- |   |                               |   |                                  |
|---|-------------------------------|---|----------------------------------|
| a | Back button                   | e | Button <i>Language selection</i> |
| b | Information bar               | f | "Manual cooking" button          |
| c | "WaveClean" button (optional) | g | "Unit functions" button          |
| d | Help button                   | h | "Automatic cooking" button       |

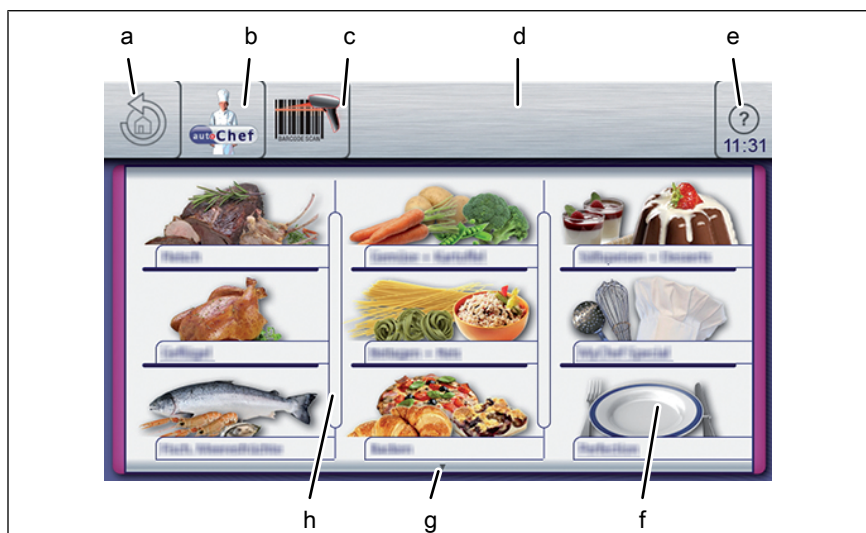

Image: Automatic cooking menu, autoChef

- |   |                        |   |                        |
|---|------------------------|---|------------------------|
| a | Back button            | e | FlexiHelp button       |
| b | "autoChef" button      | f | Category field         |
| c | Barcode scanner button | g | Next page arrow symbol |
| d | Information bar        | h | Separating bar         |

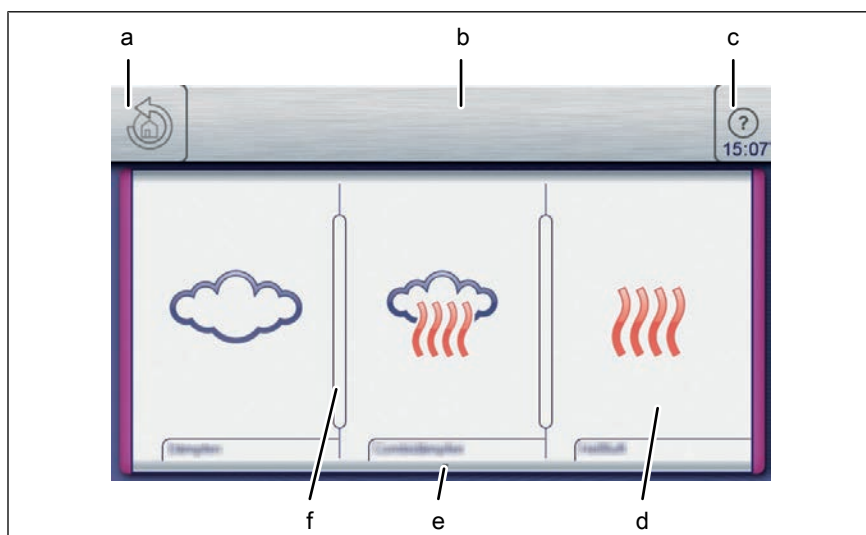

Image: Manual cooking menu

- |   |                  |   |                        |
|---|------------------|---|------------------------|
| a | Back button      | d | "Convection" field     |
| b | Information bar  | e | Next page arrow symbol |
| c | FlexiHelp button | f | Separating bar         |

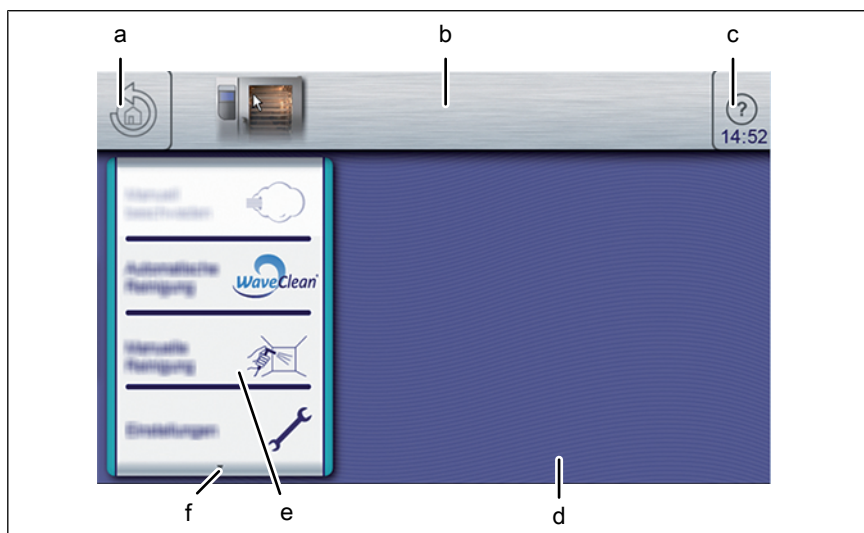

Image: Equipment functions menu

- |   |                  |   |                        |
|---|------------------|---|------------------------|
| a | Back button      | d | Window                 |
| b | Information bar  | e | Manual cleaning field  |
| c | FlexiHelp button | f | Next page arrow symbol |

## 3.5 Loading capacity

### 3.5.1 Plate capacity during regeneration

The cooking time and cooking temperature depend on the number of plates.

Design DKECOD	Plate diameter
	28 cm
615 – 615 615 – 621 621 – 621	24 and 24
115 – 615 115 – 621 121 – 615 121 – 621	40 and 24

### 3.5.2 Loading capacity

Version DKECO	Per shelf maximum (kg)	Per unit maximum (kg)
615	22,5	54
621	30	72
115	22,5	90
121	30	120

### 3.6 Standard setting values

#### 3.6.1 Core temperature standard setting

The adjustment range for the core temperature depends on the cooking mode.

Cooking mode	Standard value (°C)	Adjustment range (°C)	Alteration increments (°C)
Steaming	70	0 - 99	1
Combisteamming	70	0 - 99	1
Convection	70	0 - 99	1
Regeneration	50	0 - 99	1

#### 3.6.2 Temperature standard setting

The adjustment range for the cooking zone temperature depends on the cooking mode.

Cooking mode	Standard value (°C)	Adjustment range (°C)	Alteration increments (°C)
Steaming	100	30 - 130	1
Combisteamming	150	30 - 250	1
Convection	180	30 - 300	1
Regeneration	50	30 - 180	1

#### 3.6.3 Cooking zone humidity standard setting

The adjustment range for the cooking zone humidity depends on the cooking mode.

Cooking mode	Standard value (%)	Setting range (%)	Change increments (%)
Steaming	100	90 - 110	90 - 100 - 110
Combisteamming	90	20 - 100	20 - 40 - 70 - 90 - 100
Convection	100	0 - 100	0 - 25 - 50 - 75 - 100
Regeneration	100	0 - 100	0 - 25 - 50 - 75 - 100



## 4 Operating the unit

### ATTENTION

#### Blockage of the drain in the cooking zone

Food debris, skin and bones can clog the drain and pump.

- For very fatty food, place a sieve or perforated GN container in the lowest rack.
- After each cooking process, take a close look in the cooking chamber and pick up any residues and dispose of them properly.



#### The drain in the cooking zone must be free during operation.

Before loading the cooking zone

- Remove any food remains from the cooking zone.
- Check the drain sieve for cleanliness.
- Do not place GN containers or trays on the drain in the cooking zone.



Explanatory video clips can be selected under VideoAssist by press the Help button.



#### Reduction of acrylamide level

Regulation EU 2017/2158 has applied in Europe since 2018-04-11.

This requires that the lowest possible acrylamide level must be achieved when cooking potato products.

MKN therefore recommends the following for potato products:

- Do not exceed a cooking temperature of 220 °C, unless the food manufacturer states, that this is safe for his product.
- Avoid excessive cooking.
- If possible, use pre-blanching products.
- Observe the cooking instructions on the product packaging or otherwise stated by the food manufacturer.

### 4.1 Operating the unit in an environmentally responsible manner

If used correctly, this Combisteamer achieves very low energy consumption.

Energy consumption is reduced by:

- Avoiding continuous operation - the Combisteamer heats up very quickly, which means that continuous operation is not necessary.
- Loading the cooking zone as fully as possible - if practical, use a Combisteamer with a smaller cooking zone.

### 4.2 Switching the unit on and off

#### 4.2.1 Switching on

- Press the *On Off "I O"* button to "I".
  - ↳ The unit is now on.
  - ↳ The control system starts the power-on process automatically. The progress bar at the lower edge of the touchscreen displays the status of the process.
- ↳ The main menu appears after 1 minute and the unit is ready for use.

#### 4.2.2 Switching off



Fans may continue to run for cooling; the unit's control system is disconnected from power.

---

- Press the *On Off "I O"* button to "O".
  - ↳ The unit is now off.

### 4.3 Opening and closing the cooking zone door



The single-stage door latch is standard on sizes 6 and 10.

---



The 2-stage door lock is optional on size 6 and size 10.

---

#### 4.3.1 Opening the single-stage door latch

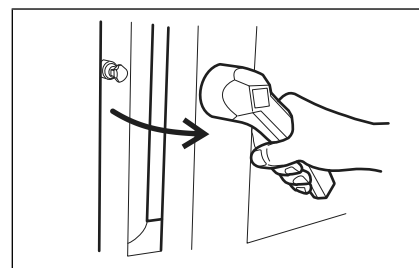
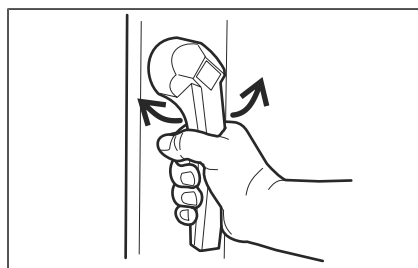

Image: Opening the single-stage door latch

1. Rotate the door handle anti-clockwise or clockwise.
    - ↳ The cooking zone door opens.
- 



If the door handle is released, it returns automatically to its initial position.

---

2. Open the cooking zone door completely.

### 4.3.2 Closing the single stage door latch

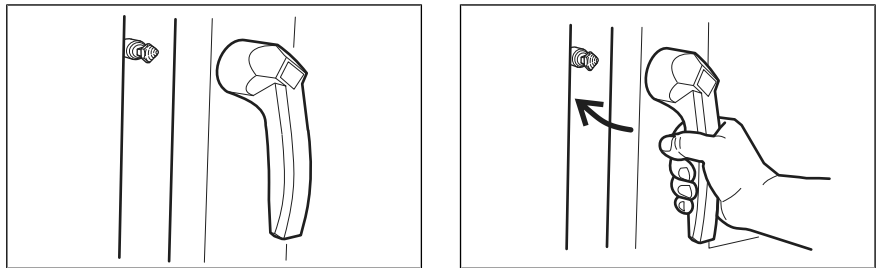

Image: Closing the single stage door latch

**Requirement** Door handle in initial position

→ Close the cooking zone door with pressure.

↳ The cooking zone door is closed.

### 4.3.3 Opening the 2-stage door lock

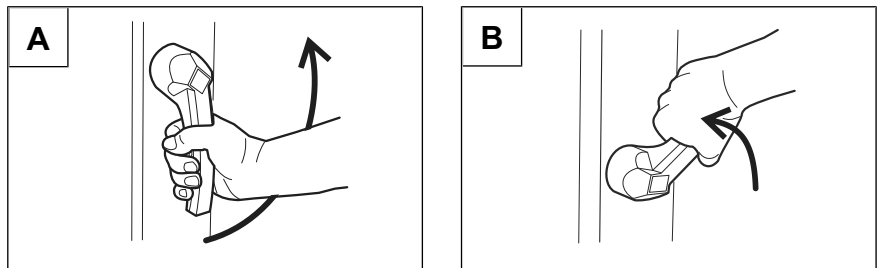

Image: Opening the 2-stage door lock



On size 6 and size 10, first rotate the door handle anti-clockwise.

1. Rotate the door handle to a horizontal position.
  - ↳ The cooking zone door opens, but is still held.
2. Continue rotating the door handle upwards.
  - ↳ The latch of the cooking zone door is unlocked.
  - ↳ Cooking zone door unlocked.



If the door handle is released, it returns automatically to its initial position.

3. Open the cooking zone door completely.
  - ↳ Cooking zone door is open.

### 4.3.4 Closing the 2-stage door lock

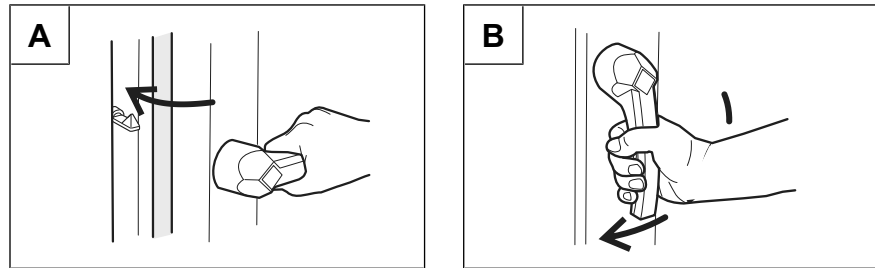

Image: Closing the two-stage door latch

**Requirement** Door handle in initial horizontal position

1. Close the cooking zone door with pressure.  
↳ The cooking zone door latches.
2. Rotate the door handle downwards.  
↳ The cooking zone door is locked.

## 4.4 Loading and emptying the unit

---



### CAUTION

#### Risk of burns from hot liquid

- Never insert a food-carrying tray with cooking liquid or goods, that will get liquid, above eye level.
  - Use only suitable trays to hold food. The food-containing trays must rest securely on the support brackets.
  - Always insert the food-containing trays into the U-rails.
- 



### CAUTION

#### Risk of physical damage and personnel injury from exceeding the loading capacity

- Do not exceed the maximum loading capacity.
- 



To not use bent or damaged support racks.

---

### 4.4.1 Loading and emptying

#### Loading

1. Open the cooking zone door.
2. Insert food-containing trays into the support racks.
3. Close the cooking zone door.
4. Start the cooking process.

### Emptying

1. Open the cooking zone door.
2. Remove the food-containing trays.
3. Remove all food residues from the drain screen.
4. Leave the cooking zone door slightly ajar.
  - ↳ This extends the service life of the door seal.
  - ↳ No moisture builds up in the cooking zone.

## 4.5 Equipment functions menu

Various functions or settings can be selected in the *Equipment functions* menu.

The equipment functions are individually set for each of the two Combisteamers.



All equipment functions can also be accessed from within a cooking program by tapping the *blue* tab.

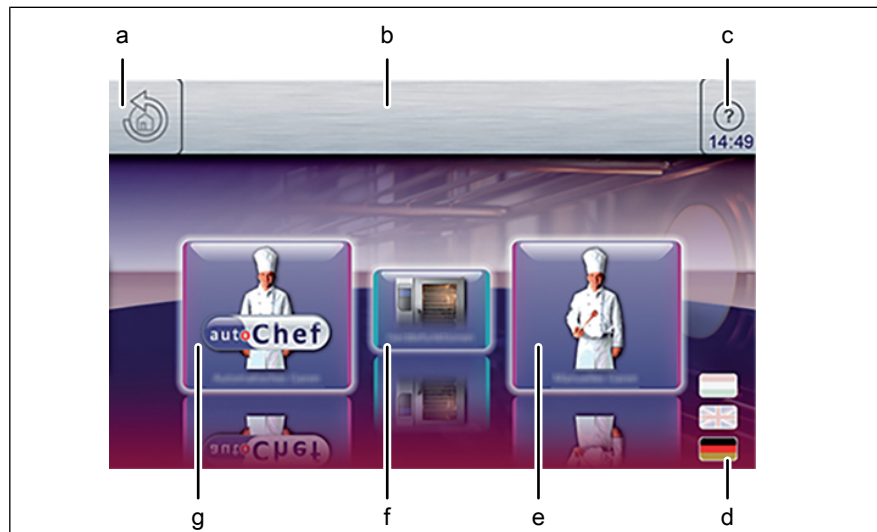

Image: Main menu

- |                             |                                |
|-----------------------------|--------------------------------|
| a Back button               | e "Manual cooking" button      |
| b Information bar           | f "Equipment functions" button |
| c FlexiHelp button          | g "Automatic cooking" button   |
| d Language selection button |                                |



The equipment information is displayed without entering a password.

### 4.5.1 Opening the equipment functions menu

**Requirement** The unit is switched on  
The Main menu is displayed

- Tap the "Equipment functions" button.
- ↳ The *Equipment functions* menu is displayed.

### 4.5.2 Changing the basic settings



The basic settings for operation can be displayed, changed and exported by entering the password "111".

---

#### Opening the Setting menu

**Requirement** *Equipment function* menu open

1. Tap the "Equipment settings" field.  
↳ The *PIN* window opens.



2. Enter the password.
3. Tap the *Confirm* button.  
↳ The *Equipment settings* menu is displayed.  
↳ The basic settings can be changed.

**In addition to those described in this chapter, there are the following further functions.**

#### Audio settings

Selection of the volume of the signal tones.

#### Operation lock

Various settings depending on whether and when the operation lock is to be activated.

Entering and changing the code word.

#### Stand-by mode

To set the stand-by mode, deactivate the operating lock.

If stand-by mode is activated, the touchscreen goes dark after the set time. The cooking zone light is switched off.

#### Setting the background lighting

This setting reduces the brightness of the touchscreen.

#### CombiDoctor

CombiDoctor uses a selectable self-diagnostic program to check the components for climate control and cleaning.

**Delete user's own cooking programs**

Delete all the cooking programs created by the user.

**Set the units**

Set the units for temperature and liquid quantities.

The possibilities for temperature are °C and °F.

The possibilities for volume are ml, fl.oz (Imp.) and fl.oz (US)

**Display the fault memory**

Call up stored faults for forwarding to Service partners.

**Import HansDampf programs**

Import existing HansDampf programs.

**Importing manufacturer's cookbook**

Import the cookbooks provided by the manufacturer.

**Select cookbook**

Select the cookbooks typical of the country.

**Cookbook lock**

Lock function for the cooking programs in autoChef.

Setting	Function
Unlocked	Deleting, changing and overwriting the cooking programs is possible
Locked	Changes in the cooking steps, for example temperature increases, are possible. The preset values apply again, when the cooking program is next called up.
Fully locked	The cooking program can only be used in the way it has been stored. Changes in the cooking steps are not possible.

**Export log data**

Export of log data for forwarding to the service technician.

**Load OEM settings**

Special settings can be loaded.

**Eco display On or Off**

Set the Eco display function.

**Select signal tones**

Selection of one of the four possible signal tones.

**Software update**

Update of the software via a USB flash drive.

**Import additional content**

Import of additional content via a USB flash drive.

### 4.5.3 Retrieving equipment information



The equipment information contains details about the software and hardware version, the serial number of the unit and contact details.

---

**Requirement** The *Setting* menu is displayed



- Tap the "Equipment information" field.
  - ↳ The *Equipment information* window is displayed.
  - ↳ Equipment information can now be read.

### 4.5.4 Setting the date and time



Observe the displayed date and time format carefully. If values are invalid, the entry is not accepted.

---

**Requirements** The *Settings* menu is displayed

1. Tap the "Set date and time" field.
  - ↳ The *Settings* window opens.
  - ↳ The *keypad* opens.



2. Enter the date and time.
  3. Tap the Confirm button.
    - ↳ The *keypad* closes.
- ↳ The date and time are set.



### 4.5.5 Presetting the language selection



A maximum of 5 languages can be specified for language selection in the main menu.



Highlighted fields represent the specified languages.  
Fields that are not highlighted are languages that have not been specified.



The currently set language cannot be deselected.

**Requirement** The *Settings* menu is displayed

1. Tap the "Select language" field.  
↳ The *Languages* menu is displayed.



2. Select or deselect the language by tapping the fields with the country's flag.  
↳ The selected languages are displayed.
3. Tap the "OK" button.  
↳ Languages have been preset for language selection and are available in the main menu.

### 4.5.6 Setting favourites

The window for *Settings for favourites* is used to select, which view of the operating field is shown after the unit has been started. This restricts the usable functions for the operator.

**Requirement** *Equipment functions* menu open

1. Tap the Settings for favourites field.  
↳ The window for *Settings for favourites* is displayed.



2. Using a wiping gesture, set the roller to the desired display.
3. Tap the "OK" button.  
↳ The window for Settings for favourites is closed.  
↳ The favourites are set.

### 4.5.7 Activating and cancelling inhibit operation



The display can be locked either by tapping and holding the information bar or automatically after a specified time without touching the display. The time until the display is locked is set in the parameter level.

#### Activating inhibit operation

**Requirement** The "Operation locked ON" function is activated in the *Setting* menu

- Tap and hold the centre of the information bar for 3 seconds.  
↳ The FlexiHelp button disappears and the Lock symbol appears in the information bar.  
↳ The touchscreen is locked.

### Cancelling inhibit operation

**Requirement** Touchscreen is locked

1. Tap on lock symbol.
    - ↳ Keypad is opened.
  2. Set password.
    - ↳ The operating lock is unlocked by entering the password "369".
- ↳ The lock symbol and the keypad disappear. The *FlexiHelp* button becomes visible in the information bar and the touchscreen is enabled.

### 4.5.8 Setting the background lighting



Image: Setting the brightness

**Requirements** The *Settings* menu is displayed

1. Tap the "Background lighting" field.
2. The menu for *Brightness in percent* is displayed.
  - ↳ The roller displays the current value.
3. Using a wiping gesture, set the roller to the desired value.
4. Confirm with the "OK" button.
  - ↳ The background lighting is set.

### 4.5.9 Setting the water filter maintenance

**Requirement** The *Settings* menu is displayed

1. Tap the "Water filter maintenance" field.
2. The *Water filter maintenance* menu is displayed.



- ↳ The display shows the entered date, when the reminder for the water filter maintenance is to be given.
- ↳ The filtered water quantity since the last filter change is displayed.
- ↳ The date for water filter maintenance can be entered with the keypad and confirmed with the "OK" field.

### 4.5.10 Possible settings in the parameter level

**Requirement** The *Settings* menu is displayed

1. Tap the "Settings parameters" field.
    - ↳ The *Settings parameters* menu is displayed.
  2. Using a wiping gesture, set the rollers to the desired parameter.
    - ↳ The designation of the selected parameter is displayed.
  3. Tap the "Read" button.
    - ↳ The current value of the selected parameter is displayed.
  4. Delete the current value with the keypad.
  5. Enter the new value with the keypad.
  6. Tap the "Write" button.
    - ↳ The displayed value is adopted for this parameter.
- ↳ The parameter is changed.

### Basic setting parameters

The unit is already preset, when it is delivered. The values in the following list can be adjusted at the parameter level.

Basic setting	Parameter s	Standard value	Adjustment range	Explanation
<b>Screen lock</b>				
Screen lock	662	0	0 = Deactivated 1 = Activated	Activate or deactivate the screen lock. The screen lock switches itself on after a certain time, if there have been no more inputs on the touchscreen.
Password	7	111	0 — 300	The password for the basic settings can be changed in this range.
<b>Cooking modes</b>				
Preselect steaming temperature	9	100	30 °C — 130 °C	Preset the temperature for steaming
Preselect Combisteam temperature	10	150	30 °C — 250 °C	Preset the temperature for Combisteam
Preselect Convection temperature	11	180	30 °C — 250 °C	Preset the temperature for Convection
Preselect regeneration temperature	12	130	30 °C — 180 °C	Preset the temperature for regeneration
<b>Ready2Cook</b>				
Ready2Cook active	607	1	0 = Not activated 1 = Activated	Indicates whether the default setting is activated or not.
Ready2Cook preheating temperature	4	15	0 — 30%	If the unit is fully loaded with a large mass (roasts, loaves of bread), increase the preheating temperature, so that the cooking zone temperature does not drop too suddenly.
<b>Cooking</b>				
SES: Use at the end of the cooking program	624	1	0 = Deactivated 1 = Activated	Default setting for Steam Exhaust System if new cooking programs are being created
Query message: Restart after interruption of cooking program	697	0	0 = No query 1 = Query only with AutoChef 2 = Query always activated	Setting for behaviour after interruption of the cooking program
Adopt changes after end of cooking program	696	0	0 = Do not adopt 1 = Adopt	Automatically save changes made at the end of a cooking program.
<b>Stand-by mode</b>				
Waiting time until standby mode	704	0	0 = Not activated 1 — 7200 s	If there have been no more inputs on the touchscreen, the background lighting is reduced. Is only activated, if the operating lock is not active.

10016528-0ABBE-J



Basic setting	Parameters	Standard value	Adjustment range	Explanation
<b>Background lighting</b>				
Brightness of the background lighting	705	100	20 — 100 %	The brightness of the background lighting can be adjusted, and it is used for example to reduce the brightness of the touchscreen in dark rooms or with Frontcooking.
<b>FlexiCombi Air</b>				
Time extension for condensation hood	5	60	0 – 600 s	Time extension for the condensation hood, after the cooking zone door has been opened

### 4.5.11 Importing video

**Requirements** WMV format  
Data size < 50 MB

1. Create the directory *VideosCustom* on a USB flash drive.
2. Save the desired video in this directory.  
↳ USB flash drive prepared.
3. Insert the USB flash drive into the MultiPort.
4. Open the *Equipment functions* menu.
5. Open the *Settings* menu.
6. Select the *Import videos* menu.

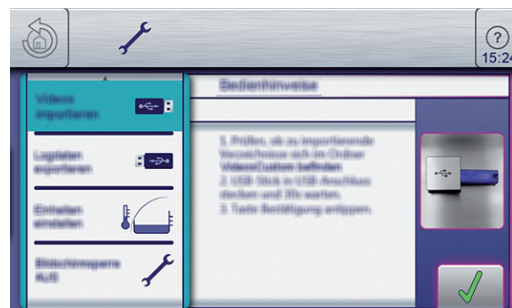

7. Follow the operating instructions.  
↳ Video imported.

## 4.5.12 Importing images

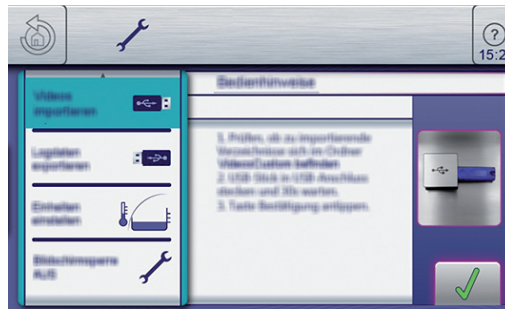

### Requirement PNG format

Image size 249x111 Pixel

Data size <50 MB

1. Create the directory *autoChefImages* on a USB flash drive.
2. Save the desired image in this directory.
  - ↳ USB flash drive prepared.
3. Insert USB flash drive into the multiport.
4. Open *Equipment functions* menu .
5. Open *Settings* menu.
6. Select menu *Additional Content*.
7. Follow the operating instructions.
  - ↳ Image imported.

### 4.5.13 Importing recipes



When converting into a HTML format, the text and graphics must be separate. For example in Microsoft Word, the text is saved under file type with the "Web page, filtered" storage filter. Before importing, make sure that the file type ends with ".html".

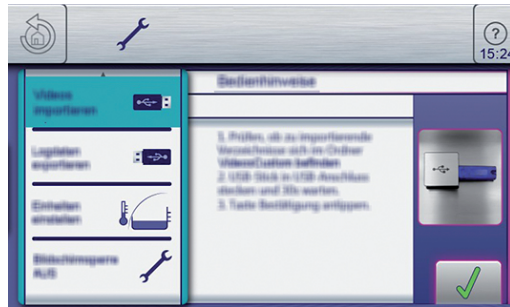

**Requirements** HTML format  
Data size < 50 MB

1. Create the directory *FCBrowserFiles* on a USB flash drive.
2. Save the desired recipe in this directory.  
↳ USB flash drive prepared.
3. Insert the USB flash drive into the MultiPort.
4. Open the *Equipment functions* menu.
5. Open the *Settings* menu.
6. Select the *Import recipe* menu.
7. Follow the operating instructions.  
↳ Recipe imported.



## 4.6 Basic functions

### 4.6.1 Setting the cooking temperature

#### ATTENTION

##### Increased wear

Continuous use of the unit with cooking temperatures above 250 °C will result in increased wear.



The temperature range differs, depending on the cooking mode. At a cooking temperature outside the allowed temperature range, the display turns red.

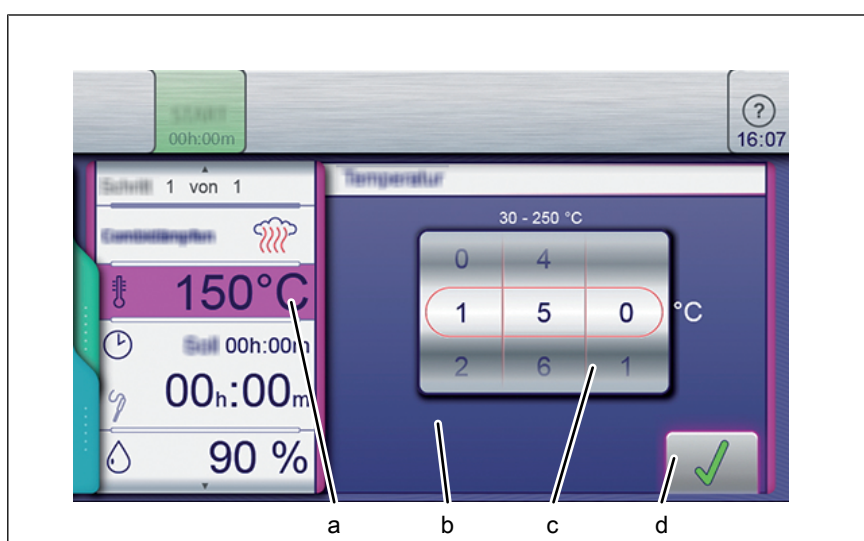

Image: Cooking temperature setting window

- |   |                   |   |                |
|---|-------------------|---|----------------|
| a | Temperature field | c | Rollers        |
| b | Setting window    | d | Confirm button |

#### Requirement Cooking program selected

1. Tap the *Cooking temperature* field.
    - ↳ The *Setting* window is displayed.
  2. Tap the *Temperature* field.
  3. Using a wiping gesture, set the rollers to the desired value.
    - ↳ Wipe up / down to increase / decrease the cooking temperature.
  4. Tap the *Confirm* button.
    - ↳ The *Setting* window closes.
    - ↳ The *Cooking mode* window displays the set cooking temperature.
- ↳ The cooking temperature is set.

## 4.6.2 Setting the cooking time and continuous operation

### Setting the cooking time

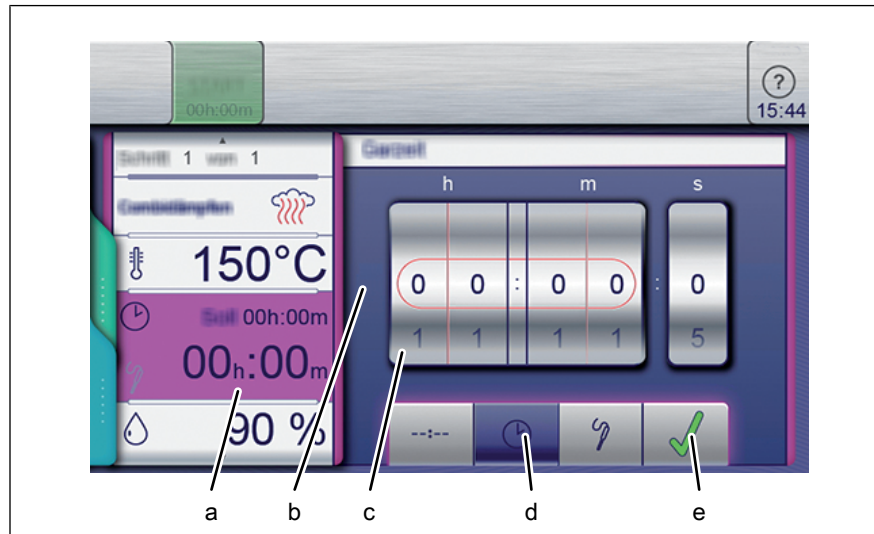

Image: Setting the cooking time

- |   |                    |   |                     |
|---|--------------------|---|---------------------|
| a | Cooking time field | d | Cooking time button |
| b | Setting window     | e | Confirm button      |
| c | Rollers            |   |                     |

#### Requirement Cooking program selected

1. Tap on *Cooking time* field.  
↳ The *Setting* window is displayed.
2. Tap on *Cooking time* button.
3. Set the rollers to the desired value with wiping gesture.  
↳ Up or down, the cooking time is increased or decreased.
4. Tap on *OK* button.  
↳ The *Setting* window is closed.  
↳ The *Cooking mode window* displays the set cooking time.  
↳ The cooking time is set.

### Setting continuous operation

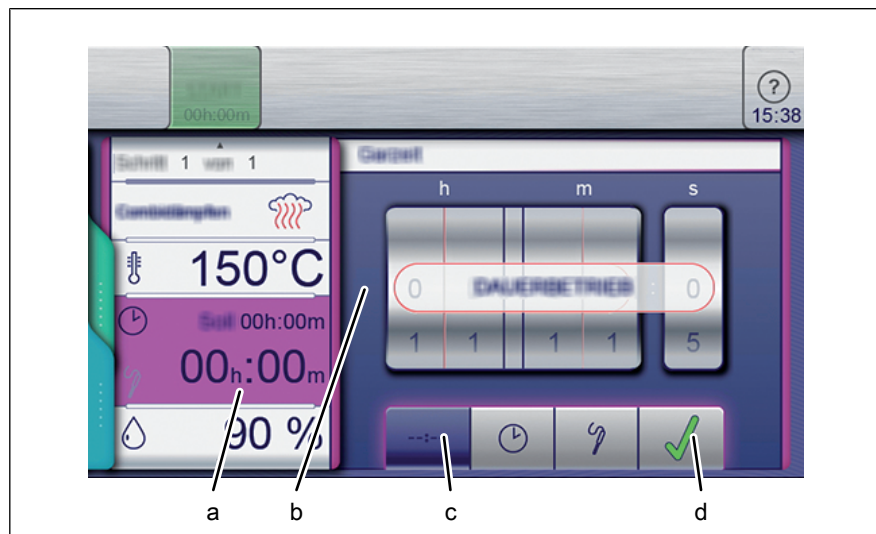

Image: Setting the cooking time to continuous operation

- |   |                    |   |                             |
|---|--------------------|---|-----------------------------|
| a | Cooking time field | c | Continuous operation button |
| b | Setting window     | d | Confirm button              |

#### Requirement Cooking program selected

1. Tap on *Cooking time* field.
    - ↳ The *Setting* window is displayed.
  2. Tap on *Continuous operation* button.
  3. Tap on *OK* button.
    - ↳ The *Setting* window is closed.
    - ↳ The *Cooking mode window* displays the set cooking time.
- ↳ The cooking time is set to continuous operation and ends after 24 hours.



A cooking step, which is running in continuous operation, can be converted to Remaining time.

## 4.6.3 Setting the core temperature

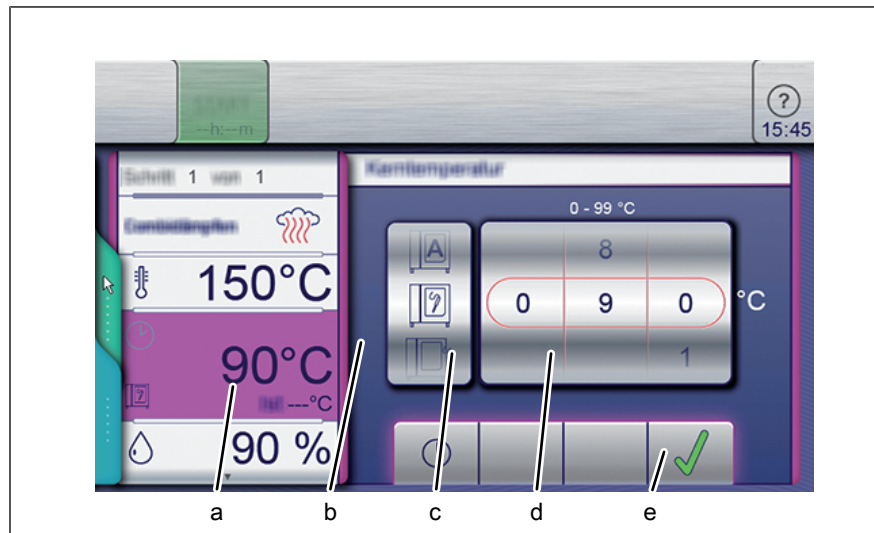

Image: Core temperature setting window for internal and external display

- a Core temperature field
- b Setting window
- c Roller for Type of core temperature sensor
- d Temperature roller
- e Confirm button

**Requirement** Cooking program selected  
Cooking time set

1. Tap on *Cooking time* field.  
↳ The *cooking time* setting window is displayed.
2. Tap on *Core temperature* field.  
↳ The *Core temperature* setting window is displayed.
3. Set the rollers to the desired value with wiping gesture.  
↳ Wipe up or down, core temperature is increased or decreased.
4. Tap on *Confirmation* button.  
↳ The *Setting* window is closed.  
↳ The *Cooking time* field changes to the *Core temperature* field.



Further notes about working with the core temperature sensor can be found under Using the core temperature sensor.

#### 4.6.4 Setting the fan speed and direction of rotation

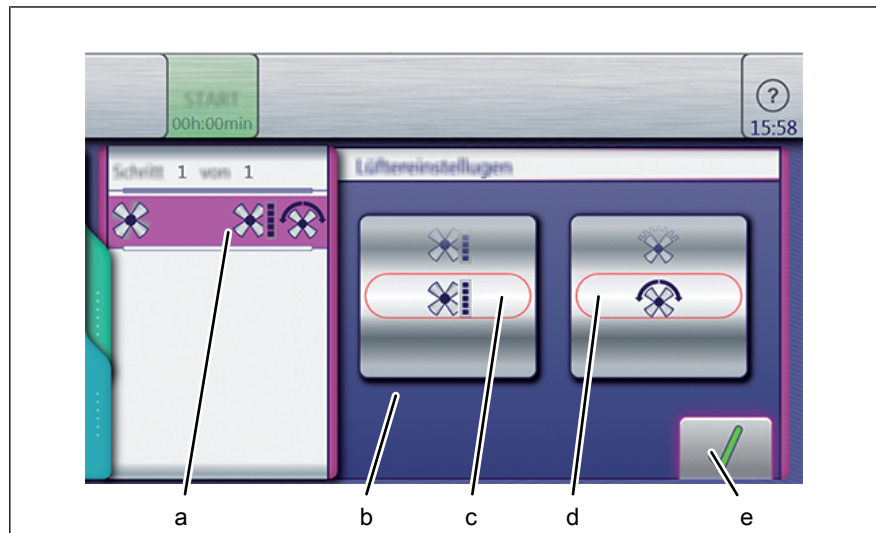

Image: Setting the fan speed and direction of rotation

- |   |                   |   |                                   |
|---|-------------------|---|-----------------------------------|
| a | Fan setting field | d | Roller for Fan rotation direction |
| b | Setting window    | e | Confirm button                    |
| c | Fan speed roller  |   |                                   |

**Requirement** Cooking program selected

1. Tap on *Fan setting* field.  
↳ The Setting window opens.
2. Set roller *fan speed* to the desired value with wiping gesture.
3. Set the roller *fan rotation direction* to the desired value with wiping gesture.
4. Tap on *OK* button.  
↳ Fan speed and fan rotation direction is set.

### 4.6.5 Using Perfection (regeneration)

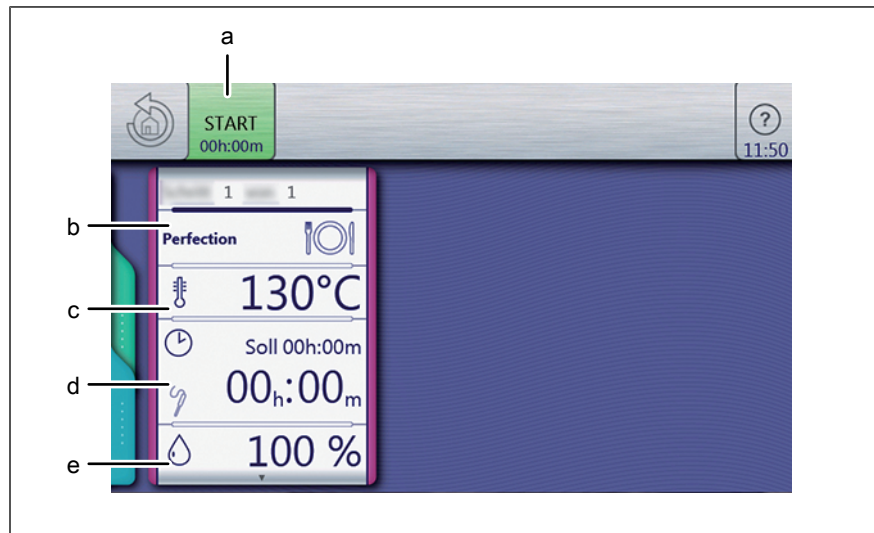

Image: Settings window for Perfection cooking mode

- |   |                    |   |                    |
|---|--------------------|---|--------------------|
| a | "Start" button     | d | Cooking time field |
| b | Cooking mode field | e | Moisture field     |
| c | Temperature field  |   |                    |

#### Starting Perfection

- Requirements** Food to be cooked is on the insert in the rack  
Door closed  
*Manual cooking* menu displayed

1. Tap the *Perfection* cooking mode field.  
↳ The *Cooking mode* window is displayed.
2. Configure the settings.  
↳ The *Cooking mode* window shows the configured settings.
3. Tap the "Start" button in the information bar.  
↳ The unit heats up.  
↳ The "Start" button is replaced with the "Stop" button.  
↳ The cooking time is updated in the *Cooking mode* window.  
↳ Perfection is started.

#### Ending Perfection

- Requirements** Perfection started  
Cooking time has not elapsed

1. Tap the "Stop" button in the information bar.
- or

2. Wait for the cooking time to end.
  - ↳ The heating of the unit is ended.
  - ↳ The "Stop" button is replaced with the "Start" button.
  - ↳ The cooking time is reset.
- ↳ Perfection is ended.

#### 4.6.6 Using PerfectHold

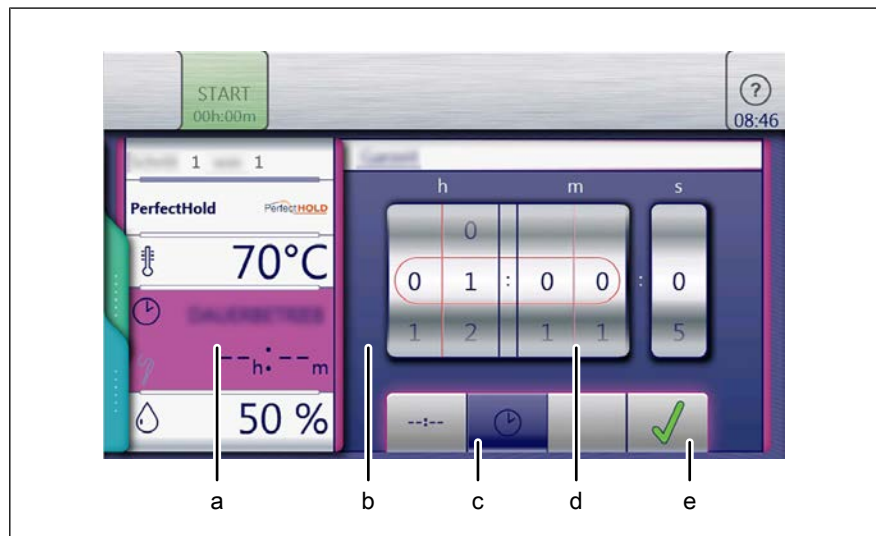

Image: PerfectHOLD settings window

- |   |                     |   |                |
|---|---------------------|---|----------------|
| a | Cooking time field  | d | Rollers        |
| b | Settings window     | e | Confirm button |
| c | Cooking time button |   |                |

- Requirements** Cooking program ended  
 Manual cooking menu open  
 Extended cooking function selected

1. Tap the *Temperature* field.
2. Using a wiping gesture, set the rollers to the desired value.
3. Tap the *Confirm* button.
  - ↳ The *Settings* window is closed.
4. Tap the *Cooking time* field.
  - ↳ The *Settings* window is displayed.
5. Tap the *Cooking time* button.
6. Using a wiping gesture, set the rollers to the desired value.
  - ↳ Wipe up / down to increase / decrease the cooking time.
7. Tap the *Confirm* button.
  - ↳ The *Settings* window is closed.
  - ↳ The *Cooking mode* window shows the set cooking time.
- ↳ PerfectHOLD is set as time-controlled.

## 4.6.7 Setting Ready2Cook

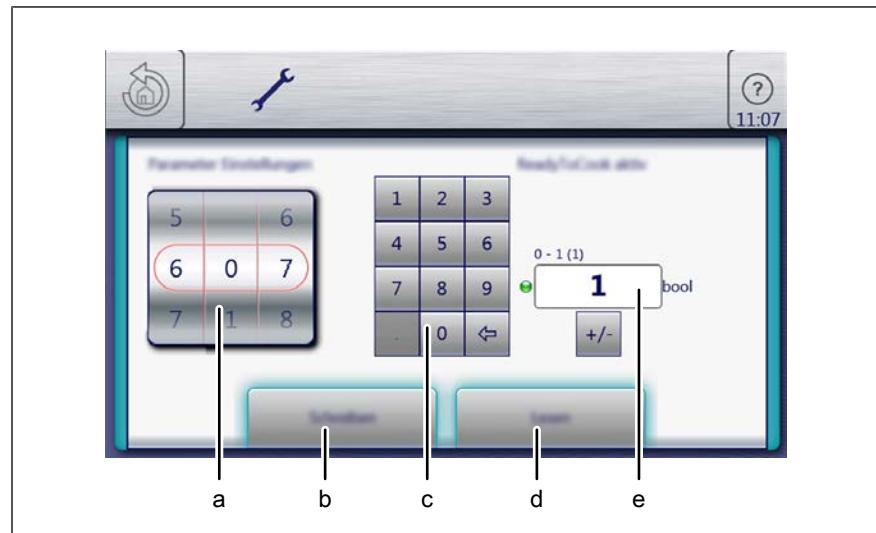

Image: Parameters window for "Ready2Cook" settings

- a Rollers
- b Write button
- c Keypad button
- d Read button
- e Display

### Requirement *Equipment function menu open*

1. Tap on "*Equipment settings*" field field.
  2. Set PIN 111 and confirm.
  3. Tap on *Parameter settings* field.
    - ↳ The *Parameter Settings* menu is displayed.
  4. Set the rollers to the desired value with wiping gesture.
    - ↳ The name of the selected parameter is displayed.
  5. Tap on *Read* button.
    - ↳ The current value is displayed.
    - ↳ Switch the function on or off if necessary.
  6. Delete current value using the keypad.
  7. Set new value using the keypad.
  8. Tap on *Write* button.
    - ↳ The displayed value is accepted.
- ↳ *Ready2Cook* function is set.



## 4.6.8 Using start-time preselection

### Setting start-time preselection

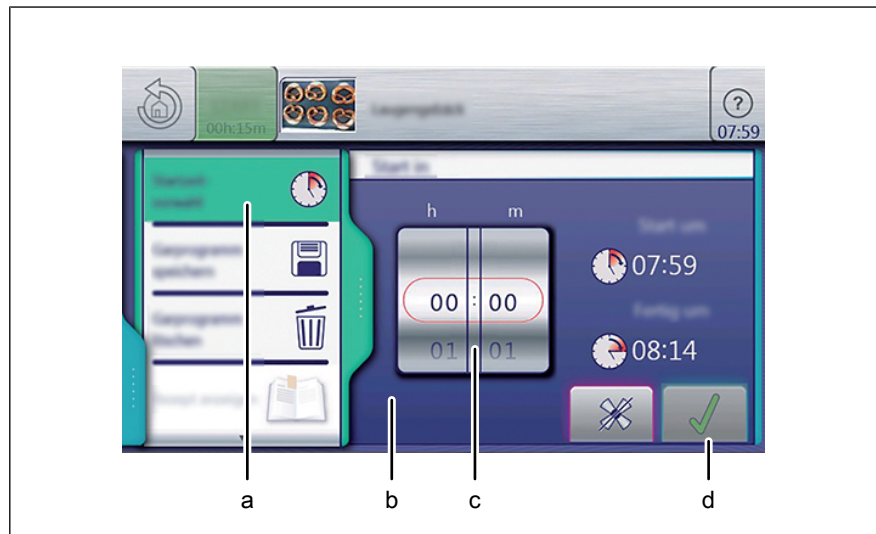

Image: Settings window for start-time preselection

- |   |                                       |   |                       |
|---|---------------------------------------|---|-----------------------|
| a | <i>Start-time preselection</i> field  | c | Rollers               |
| b | <i>Start-time preselection</i> window | d | <i>Confirm</i> button |

**Requirement** Cooking program selected  
*Auxiliary functions* menu open

1. Tap on the *Start-time preselection* field.
  2. Using a wiping gesture, set the rollers to the desired value.
    - ↳ Swipe upwards or downwards.
    - ↳ The start time is set in minutes and seconds.
  3. Tap on the *OK* button.
    - ↳ The *Start-time preselection* window displays the set start time.
    - ↳ The beginning and end of the start time is displayed in real time.
- ↳ The start-time preselection is set as time-controlled.

## Changing start-time preselection

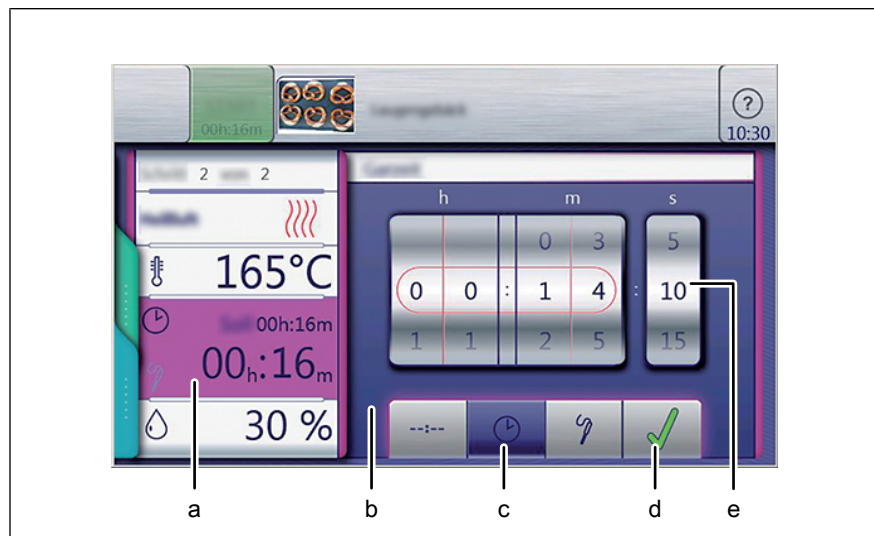

Image: Changing the Settings window for start-time preselection

- a *Start-time preselection* field
- b *Start-time preselection* window
- c *Start time* button
- d *Confirm* button
- e Rollers

- Requirements** Cooking program ended  
*AutoChef* automatic cooking menu open  
Extended cooking function selected

1. Tap the *Start-time preselection* button.
  - ↳ The *Start-time preselection* field shows the set preselection time.
2. Using a wiping gesture, set the rollers to the desired value.
3. Tap the *Confirm* button.
  - ↳ Start-time preselection is set again.

## 4.6.9 Using Steam Exhaust System (SES)



*Steam Exhaust System (SES)* automatically sucks the steam out of the cooking zone.

It is switched on as standard and can be switched off for individual programs.

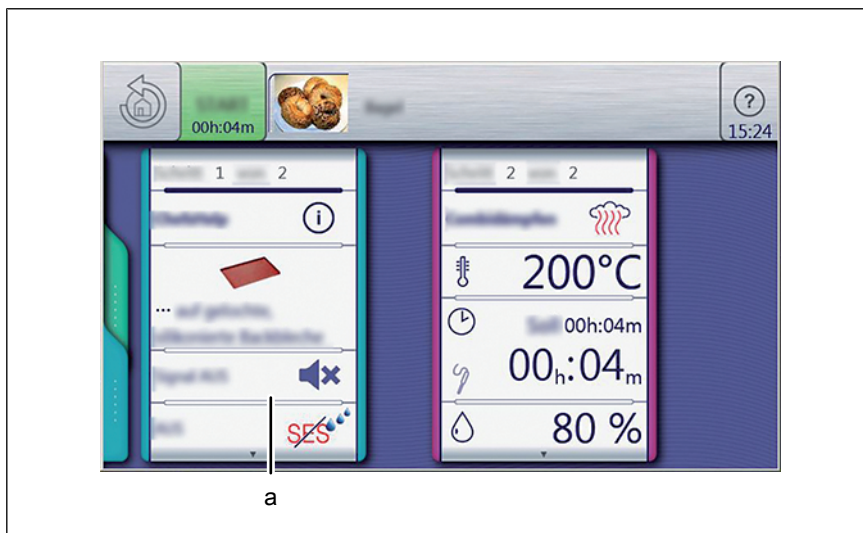

Image: Steam Exhaust System (SES) selection window

a *Steam Exhaust System* field

### Requirements *Manual cooking* menu open

Desired cooking mode selected

First step of the cooking program created

1. Tap the field for the desired cooking mode.
2. Open the next page with an upwards wiping gesture.
  - ↳ The next page is opened.
  - ↳ The page with the *SES* field is displayed.
3. Switch the function on or off as required.
4. Tap the *SES* field.
  - ↳ The "ON" display changes automatically to "OFF" or vice versa.
  - ↳ The *SES* function is set.

4.6.10 HoodIn



*HoodIn* ensures a reduced amount of vapor in the cooking chamber at the end of a cooking process before the cooking chamber door is opened.

The basic settings of the *HoodIn* function can be changed in the parameters.

Depending on the setting, cooking method and cooking product, water consumption may be increased.

4.6.11 Using RackControl2



During the cooking process, set parameters such as cooking time or core temperature can be altered for selected racks. The cooking process is not interrupted.

Parameters such as cooking zone humidity, cooking zone temperature and fan speed can be called up and set.

Changes only apply to the cooking program currently running, and they are not adopted as default settings.

Setting and starting RackControl2

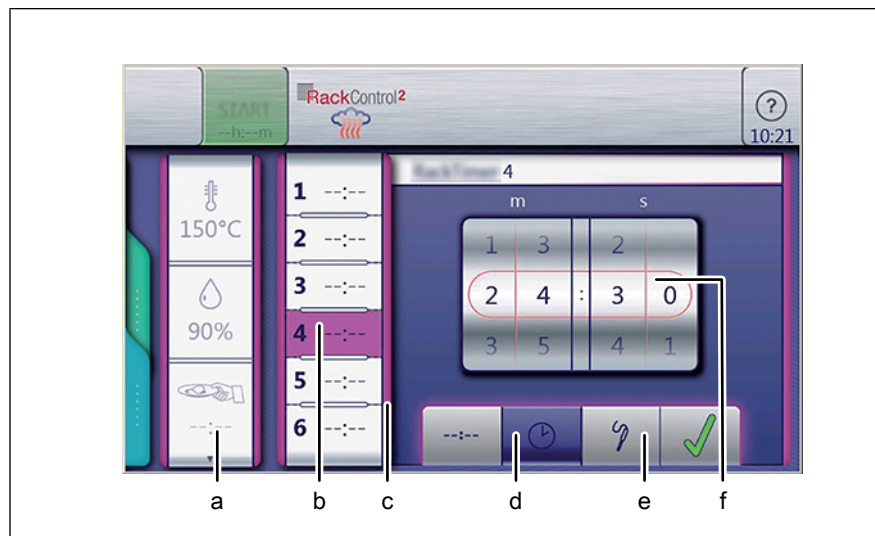

Image: Settings window for RackControl2 cooking time

- a Settings field
- b Rack field
- c Start time window
- d Start time button
- e Confirm button
- f Rollers



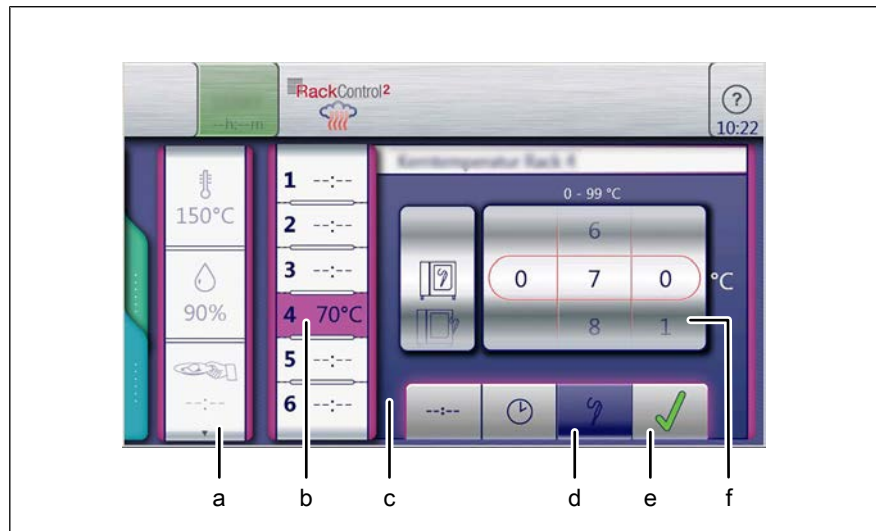

Image: Settings window for RackControl2 core temperature

- |                           |                           |
|---------------------------|---------------------------|
| a Settings field          | d Core temperature button |
| b Core temperature field  | e Confirm button          |
| c Core temperature window | f Rollers                 |

**Requirements** *Manual cooking* field selected

1. Tap the *RackControl2* field.
2. Tap the *Cooking mode* field.
3. Tap the *Settings* field.
4. Open the next page with an upwards wiping gesture.
  - ↳ The next page with the *Fan setting* field is displayed.
5. Select the fan settings as required.
6. Select the desired rack.
7. Configure the desired settings and confirm (see "Setting cooking time" and "Setting core temperature").
  - ↳ RackControl2 for selected rack is set.
8. Configure the settings for further racks as required.
9. Tap the "Start" button in the information bar.
  - ↳ The display changes to "Actual display".
  - ↳ The unit heats up.
  - ↳ The "Start" button is replaced with the "Stop" button.
- ↳ RackControl2 is started.

## Ending RackControl2

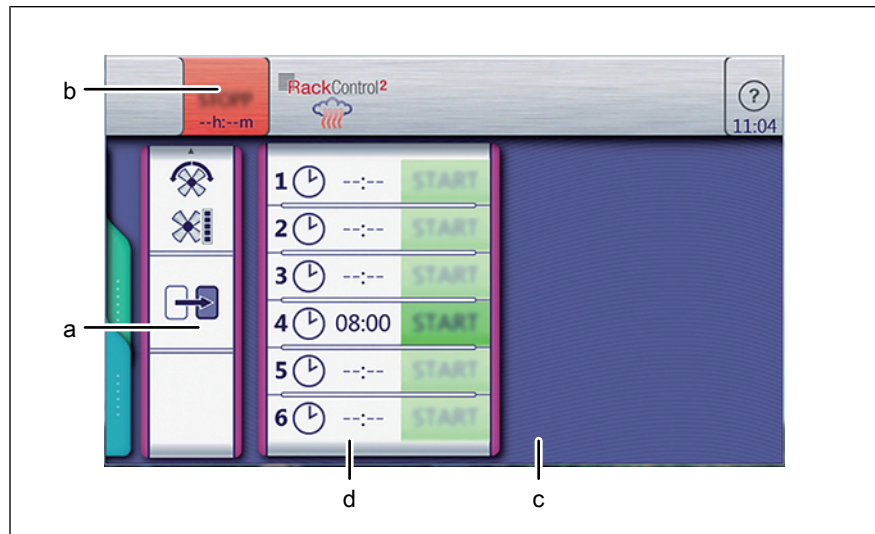

Image: Ending RackControl2 window early

a Continue field  
b Stop button

c Settings window  
d Rack field

### Requirements RackControl2 started

Preheating temperature not reached

1. Tap the *RackControl2* window.  
↳ The last *Settings* display is shown.
2. Open the next page with an upwards wiping gesture.
3. Tap the *Continue* field.  
↳ Preheating is interrupted.  
↳ RackControl2 starts with the actual temperature.

4.6.12 Using FamilyMix

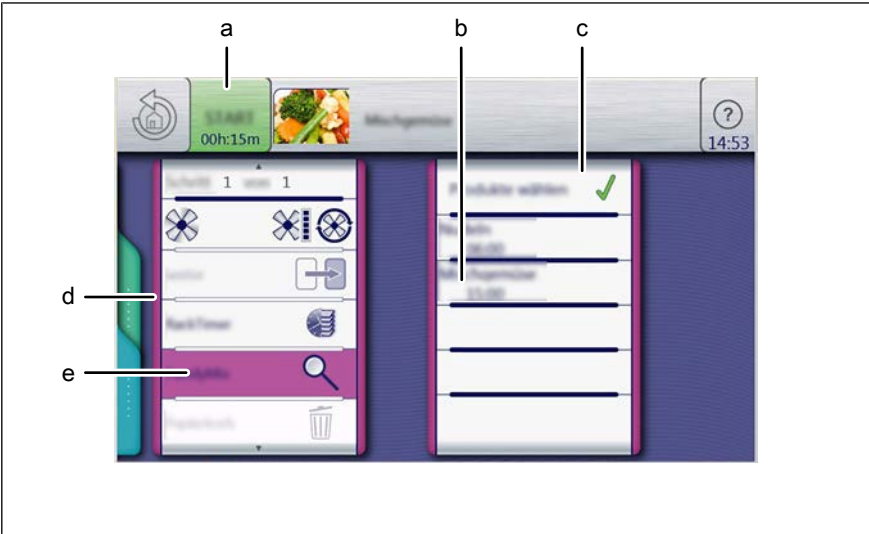

Image: FamilyMix selection window

- a Start button
- b Product overview field
- c Product field
- d Settings field
- e FamilyMix field

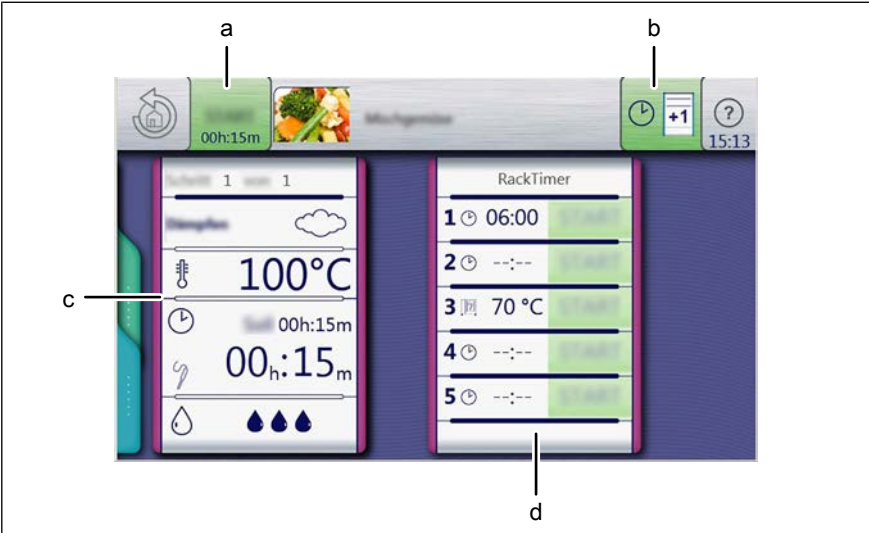

Image: FamilyMix settings window

- a Start button
- b Extended cooking time button
- c Settings field
- d RackTimer field



### Requirements *Manual cooking* field selected

Cooking program loaded

1. Tap the *Settings* field.
  2. Tap the *FamilyMix* field.
  3. Tap the *Product overview* field and select the product.
    - ↳ Tap the *Product* field: Product is selected.
    - ↳ Tap the *Product* field again: Product selection is cancelled.
  4. Tap the "Start" button.
    - ↳ The display changes to "Ready2Cook".
    - ↳ The unit heats up.
    - ↳ The "Start" button is replaced with the "Stop" button.
  5. Wait for the cooking time to end.
    - ↳ The heating of the unit is ended.
    - ↳ The "Stop" button is replaced with the "Start" button.
    - ↳ The cooking time is reset.
- ↳ The *FamilyMix* function is set.

### 4.6.13 Using the Continue cooking function



If products with different preset cooking times are selected, the cooking time for selected products can be individually extended.



The *Continue cooking* function can be set in 1-minute increments up to a maximum of 5 minutes.

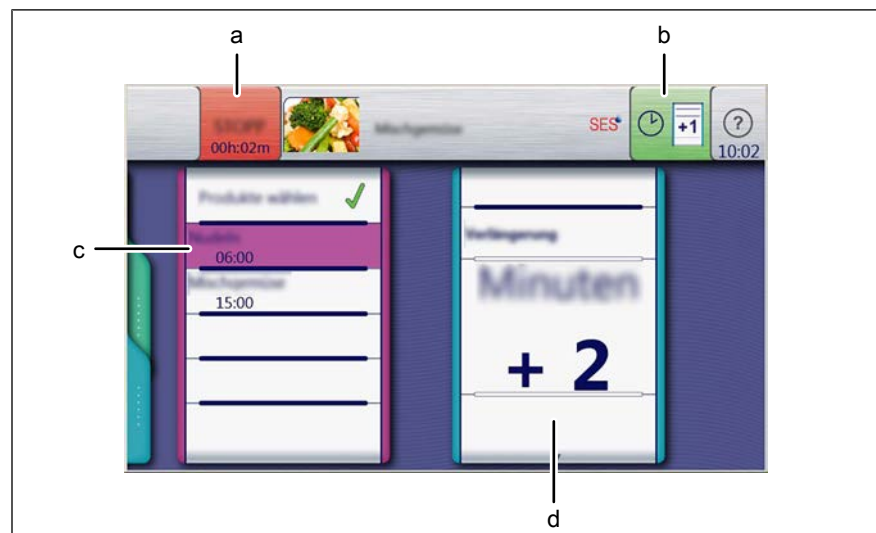

Image: Selection window for cooking time extension

- |   |                         |   |                        |
|---|-------------------------|---|------------------------|
| a | Stop button             | c | Product field          |
| b | Continue cooking button | d | Continue cooking field |



**Requirements** Cooking program selected*RackTimer* function set

1. Tap the "Start" button.
    - ↳ The unit heats up.
    - ↳ The cooking program starts.
    - ↳ The "Start" button is replaced with the "Stop" button.
  2. Press the "Stop" button.
    - ↳ The cooking program is interrupted.
    - ↳ The "Continue cooking" button appears in the information bar.
  3. Tap the "Continue cooking" button.
  4. Set the desired time for Continue cooking.
    - ↳ The cooking time is increased in 1-minute increments.
    - ↳ The altered cooking time only applies to the current cooking program.
    - ↳ It does not change the saved cooking program.
    - ↳ The *Continue cooking* function is set.
  5. Tap the "Start" button.
    - ↳ The cooking program starts.
    - ↳ The cooking time is extended by the desired time.
- ↳ The *Continue cooking* function is performed.

### 4.6.14 Setting manual humidification

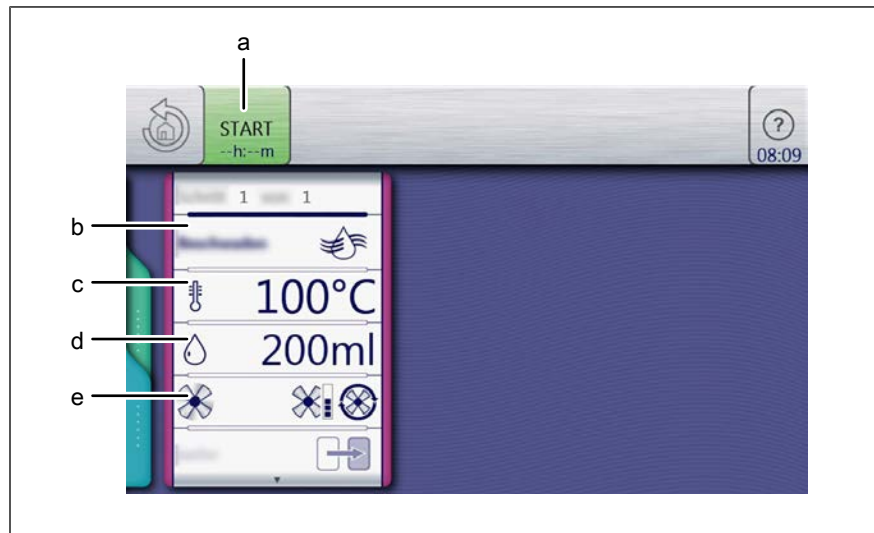

Image: Settings window for manual humidification

- |                               |                        |
|-------------------------------|------------------------|
| a "Start" button              | d Humidity level field |
| b Manual humidification field | e Fan setting field    |
| c Temperature field           |                        |

**Requirements** Manual cooking menu open  
Extended cooking function selected

1. Tap the *Temperature* field.
  2. Using a wiping gesture, set the rollers to the desired value.  
↳ Upwards or downwards, cooking temperature is increased or reduced.
  3. Tap the *Confirm* button.  
↳ The *Settings* window is closed.
  4. Tap the *Target injection quantity* field.  
↳ The *Settings* window is displayed.
  5. Using a wiping gesture, set the rollers to the desired value.  
↳ Upwards or downwards, injection quantity is increased or reduced.
  6. Tap the *Confirm* button.  
↳ The *Settings* window is closed.
- ↳ Manual humidification is set.

## 4.6.15 Setting the rest stage



The *Insert rest stage* function is possible at any time.

Without saving, the stage only applies to the current cooking program.



Image: Window for Insert rest stage

a Start button

b Rest stage field

**Requirements** *Automatic cooking* menu open

Cooking program selected

1. Select the *New step* function.
2. Tap the *Rest stage* field.
  - ↳ The *Manual cooking* menu appears.
3. Configure the settings.
  - ↳ Set the cooking mode.
  - ↳ Set the temperature.
  - ↳ Set the time.
  - ↳ Set the moisture.
4. Tap the "Start" button.
  - ↳ *Rest stage* is added to the current program.
  - ↳ *Rest stage* is not saved in the cooking program.
5. Save the cooking program.
  - ↳ *Rest stage* is saved in the cooking program.

### 4.6.16 Using QualityControl



*QualityControl* is a cooking time optimisation function, which adjusts the temperature automatically. It optimises the preheating process.

It is switched on as standard and can be switched off for individual programs.



The particular setting applies to all cooking programs until it is changed.



Image: QualityControl selection window

a *QualityControl* field

**Requirements** *Equipment function* menu open

1. Tap the *Settings* field.
2. Enter PIN *111* and confirm.
  - ↳ The *QualityControl* field is displayed.
3. Switch the function on or off as required.
4. Tap the *QualityControl* field.
  - ↳ The "ON" display changes automatically to "OFF" or vice versa.
  - ↳ The *QualityControl* function is set.

#### 4.6.17 Using low-temperature cooking

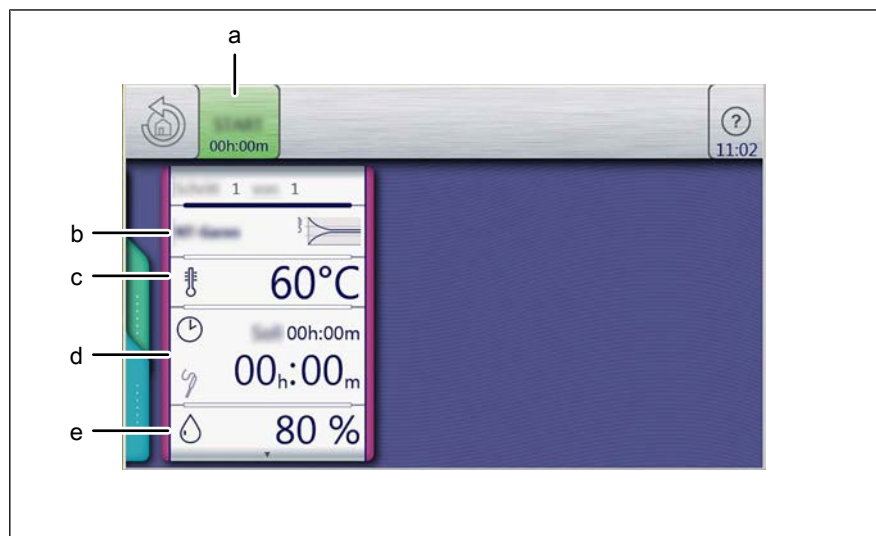

Image: Settings window for Delta-T cooking mode

- |   |                             |
|---|-----------------------------|
| a "Start" button                              | d <i>Cooking time</i> field |
| b <i>Cooking mode</i> field                   | e <i>Moisture</i> field     |
| c <i>Cooking temperature difference</i> field |                             |

#### Starting low-temperature cooking

- Requirements**
- Food to be cooked is on the insert in the rack
  - Core temperature sensor set
  - Door closed
  - Manual cooking* menu displayed

1. Tap the *Low-temperature cooking* mode field.
    - ↳ The *Cooking mode* window is displayed.
  2. Configure the settings.
    - ↳ The *Cooking mode* window shows the configured settings.
  3. Tap the "Start" button in the information bar.
    - ↳ The unit heats up.
    - ↳ The "Start" button is replaced with the "Stop" button.
    - ↳ The cooking time is updated in the *Cooking mode* window.
- ↳ Low-temperature cooking is started.

#### Ending low-temperature cooking

- Requirements**
- Low-temperature cooking started
  - Cooking time has not elapsed

1. Tap the "Stop" button in the information bar.
- or

2. Wait for the cooking time to end.
  - ↳ The heating of the unit is ended.
  - ↳ The "Stop" button is replaced with the "Start" button.
  - ↳ The cooking time is reset.
- ↳ Low-temperature cooking is ended.

### 4.6.18 Using Delta-T cooking

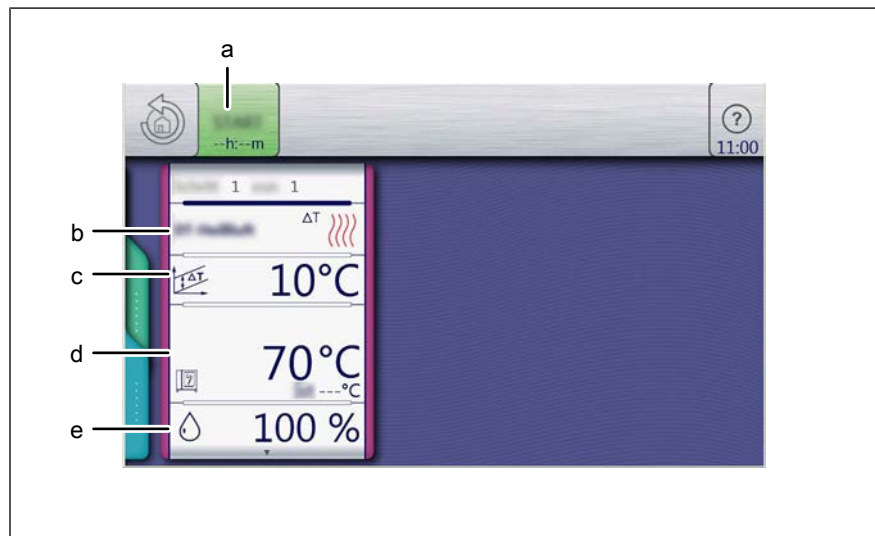

Image: Settings window for Delta-T cooking mode

- |  |                          |
|--|--------------------------|
| a "Start" button                       | d Core temperature field |
| b Cooking mode field                   | e Moisture field         |
| c Cooking temperature difference field |                          |

### Starting Delta-T cooking

- Requirements**
- Food to be cooked is on the insert in the rack
  - Core temperature sensor set
  - Door closed
  - Manual cooking menu displayed

1. Tap the *Delta-T cooking* mode field.
  - ↳ The *Cooking mode* window is displayed.
2. Configure the settings.
  - ↳ The *Cooking mode* window shows the configured settings.
3. Tap the "Start" button in the information bar.
  - ↳ The unit heats up.
  - ↳ The "Start" button is replaced with the "Stop" button.
  - ↳ The cooking time is updated in the *Cooking mode* window.
- ↳ Delta-T cooking is started.

### Ending Delta-T cooking

**Requirements**

Delta-T cooking started  
Cooking time has not elapsed

1. Tap the "Stop" button in the information bar.

or

2. Wait for the cooking time to end.

↳ The heating of the unit is ended.

↳ The "Stop" button is replaced with the "Start" button.

↳ The cooking time is reset.

↳ Delta-T cooking is ended.

### 4.6.19 Inserting and removing a USB flash drive



The USB port on the left is for the top Combisteamer; the USB port on the right is for the bottom Combisteamer.

#### Inserting a USB flash drive

**Requirement**

USB flash drive with a minimum of 2 GB and maximum of 32 GB available storage capacity (not included with delivery)

USB flash drive not write-protected

→ Insert the USB flash drive.

↳ The USB flash drive is ready after at most 20 seconds.

#### Removing the USB flash drive

**Requirement**

Exporting or importing of data completed

→ Remove the USB flash drive.

### 4.6.20 Exporting the HACCP log

**Requirement** USB flash drive inserted  
User logged in with password under unit settings

1. Tap the "Export HACCP" field.

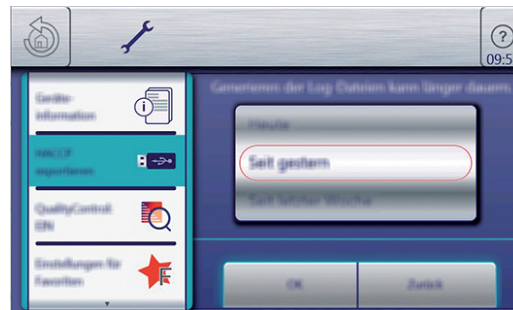

2. Select the time period of the logs.
3. Tap the *Confirm* button.
  - ↳ The *Operating instructions* window opens.
4. Tap the *Confirm* button.
  - ↳ The HACCP log is exported to the USB flash drive.
  - ↳ The *Confirmation* window opens.
5. Tap the *Confirm* button.
  - ↳ The *Confirmation* window closes.



The HACCP log can also be transferred via a kitchen management system.

---



## 4.7 Using the core temperature sensor



### WARNING

#### Risk of injury from a bursting core temperature sensor

- The core temperature sensor can burst as the result of overheating of the measuring tip.
- Never heat a core temperature sensor with an open flame or other heat source.

### ATTENTION

#### Risk of property damage from improper handling of the core temperature sensor

- Do not let the integrated core temperature sensor hang out of the unit.
- Before removing the food, grasp the core temperature probe by the handle and remove it from the food.



A core temperature measurement is always possible, if the core temperature sensor is inserted in the food being cooked. Also before or after a cooking process or during a time-controlled cooking step.



Measuring the core temperature is recommended for all types of cooking to achieve an optimal result.

### 4.7.1 Measuring with a 4-point core temperature sensor

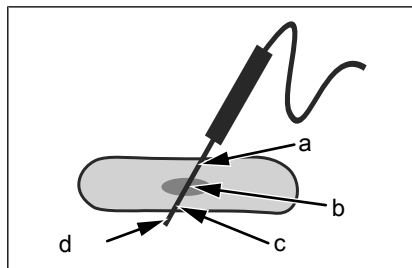

Image: Core temperature sensor with four measuring points

- Insert the core temperature sensor completely into the food being cooked.
- Insert the core temperature sensor into the thickest point of the food being cooked.
- If there is a bone in the food being cooked, insert the core temperature sensor close to the bone.
- When elongated pieces of food are being cooked, insert the core temperature sensor across the food to avoid a hole in the centre of the slice.
- When cooking poultry, insert the core temperature sensor into the inside of the leg.

### 4.7.2 Measuring with a sous-vide core temperature sensor



The sous-vide core temperature sensor, which is available as an accessory, is connected to the *Core temperature sensorconnection* outside the unit.

---

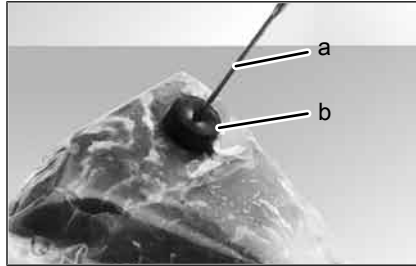

Image: Sous-vide core temperature sensor with sous-vide pads

- Attach foam rubber or expanded rubber sous-vide pads to the vacuum-packed food to be cooked.
- Always insert the core temperature sensor through the sous-vide pads completely into the food to be cooked.
- Insert the core temperature sensor into the thickest section of the food to be cooked.
- When food with a bone is being cooked, insert the core temperature sensor close to the bone.
- When elongated pieces of food are being cooked, insert the core temperature sensor across the food to avoid a hole in the centre of the slice.
- When cooking poultry, insert the core temperature sensor into the inside of the leg.

### 4.7.3 Measuring the core temperature when cooking frozen food



When cooking frozen food, measuring with a sous-vide core temperature sensor is not possible.

---

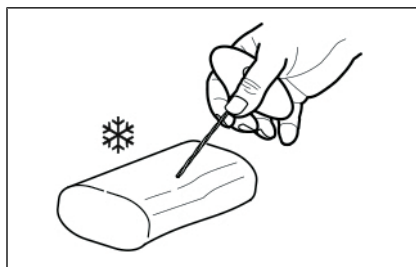
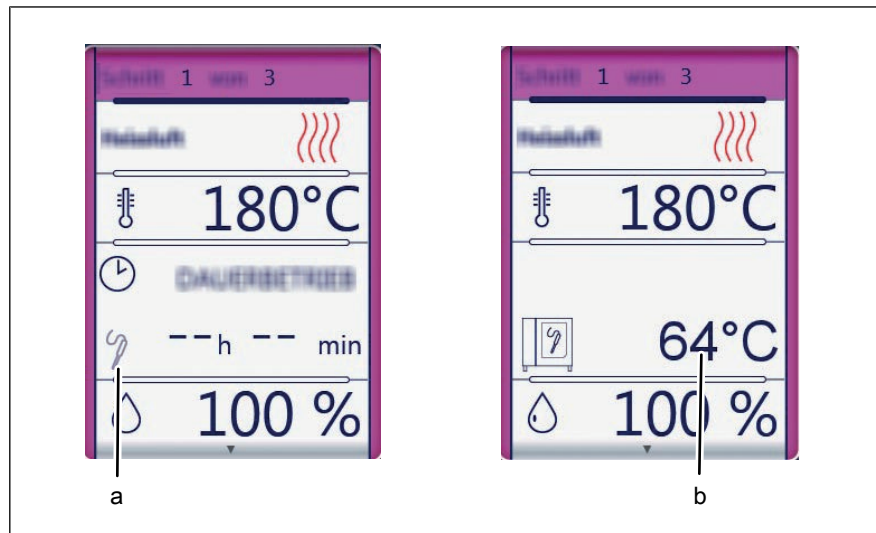

Image: Drilling a hole with a hand drill

1. Use a hand drill to make a hole for inserting the sensor.
2. Place the food to be cooked on the baking sheet or into the cooking pan.
3. Place the cooking sheet or cooking pan into the unit.
4. Insert the core temperature sensor into the food being cooked.

#### 4.7.4 Core temperature display with time-controlled cooking process



a Core temperature button

b Core temperature display

**Requirement** Core temperature sensor in the food being cooked  
Time-controlled cooking process is running

1. Tap the *Core temperature* button in the cooking step display.  
↳ The current core temperature is displayed for 5 seconds.

#### 4.7.5 Core temperature display outside the cooking process

**Requirement** Core temperature sensor in the food being cooked

1. Open the *Equipment function* menu.
2. Tap the "Measure core temperature" button on the second page.

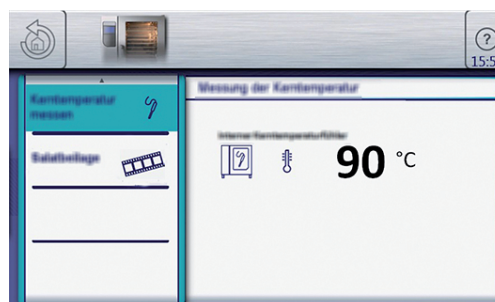

↳ The core temperature is displayed.

### 4.8 Manual cooking

Cooking modes and other functions are available in the Manual cooking mode. Selecting one of these components automatically creates a single-step cooking program.

Settings such as Cooking mode, Cooking temperature and Cooking time are specified, and the cooking step is either started or saved.

#### 4.8.1 Opening the Manual cooking menu

**Requirement** The unit is on  
The main menu is displayed

→ Tap the "Manual cooking" button.

↳ The *Manual cooking* menu is displayed.

#### 4.8.2 Creating a cooking program step

**Requirement** The unit is switched on  
The *Manual cooking* menu is displayed  
Cooking mode selected

1. Tap the *Cooking temperature* field.

↳ The *Setting* window is displayed.

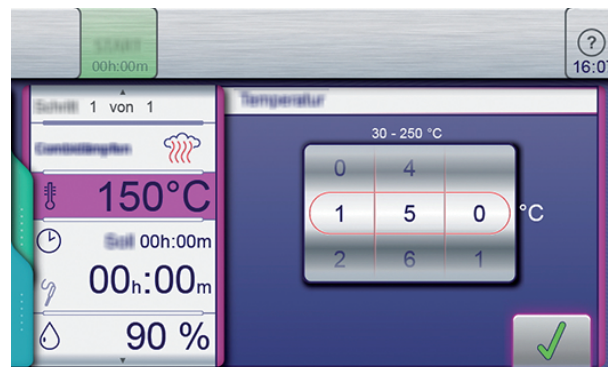

2. Using a wiping gesture, set the rollers to the desired value.

3. Tap the *Confirm* button.

↳ The *Setting* window closes.

4. Tap the *Cooking time* field.

↳ The *Setting* window is displayed.

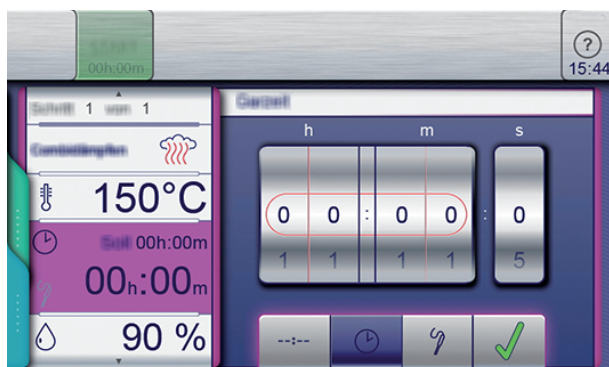

5. Tap the *Continuous operation* button, the *Cooking time* button or the *Core temperature* button.
6. Using a wiping gesture, set the rollers to the desired value.
7. Tap the *Confirm* button.
  - ↳ The *Setting* window closes.
8. Tap *Cooking zone humidity*.
  - ↳ The *Setting* window is displayed.

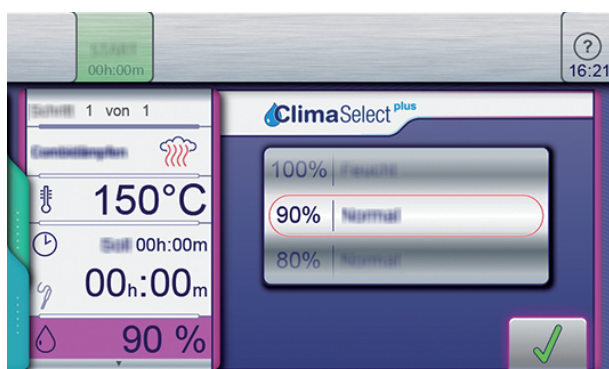

9. Using a wiping gesture, set the roller to the desired value.
10. Tap the *Confirm* button.
  - ↳ The *Setting* window closes.
11. Using a wiping gesture, change to the next page and make further settings.
12. Tap the *Fan* field.
  - ↳ The *Setting* window is displayed.

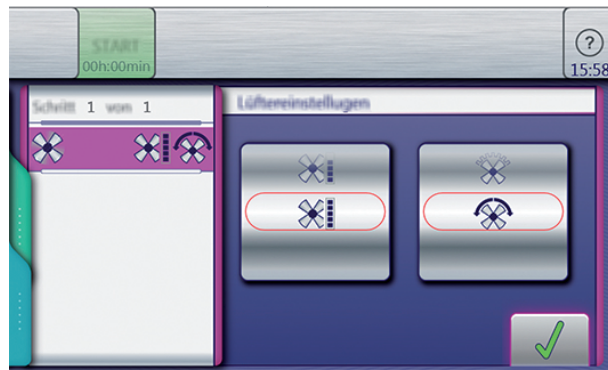

13. Set the fan speed and direction of rotation.
14. Using a wiping gesture, set the rollers to the desired value.
15. Tap the *Confirm* button.

↳ The *Setting* window closes.

↳ The cooking program step can be started.

---

### Tip

The cooking mode can also be changed while entering the cooking step.

- Tap the *Cooking mode* field.
    - ⇒ Possible selections appear.
  - Tap the cooking mode.
    - ⇒ The standard values of the selected cooking mode are displayed.
  - Modify the values.
    - ⇒ Cooking mode for this cooking step is changed.
-

## 4.9 Creating and managing your own cooking programs

Cooking modes and other functions are available in the *Manual cooking* menu. Using these components, users can create their own programs.

### ATTENTION

#### Risk of physical damage from data loss

Regularly save your own cooking programs on an external memory medium, for example a USB flash drive.

### 4.9.1 Creating a cooking program

#### Creating a cooking program step

**Requirement** *Manual cooking* menu open

1. Tap the field for the desired cooking mode.
  - ↳ The first step of the cooking program is created.
  - ↳ The display for the cooking program step shows "Step 1 of 1".
2. Modify the desired settings for the first step.
  - ↳ The first step of the cooking program has been created.

#### Adding cooking program steps

3. A wiping gesture upward opens the next page.
  - ↳ The next page is displayed.

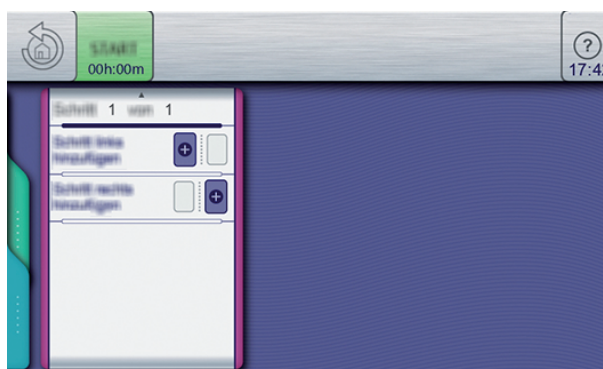

4. Tap the field for "Add step on the left".
  - or
  - 5. the field for "Add step on the right".
    - ↳ The "New step" window opens.
  - 6. Select the cooking mode or function in the window by tapping it.
    - ↳ The display of the cooking program step in the window shows the current position of the new step in the cooking program.
  - 7. Modify the settings for the step.
    - ↳ The new step is added.

### Deleting a cooking program step

---



If a cooking program has only one step, it cannot be deleted.  
The function is not active.

---

8. Select the step.

9. A wiping gesture upward opens the next page.

↳ The next page for the step is displayed.



10. Tap the "Delete step" field.

↳ The *Delete* window is displayed.

11. Tap the "Yes" button.

↳ This deletes the step.

↳ The positions of the remaining steps in the cooking program are updated.

↳ The step is deleted.



## 4.9.2 Saving the cooking program

### ATTENTION

#### Risk of physical damage from data loss

Regularly save your own cooking programs on an external memory medium, for example a USB flash drive.



Cooking programs that have been created can be saved prior to starting or after completion of the cooking program.



To save a cooking program, at least one cooking program name and one category must be specified.

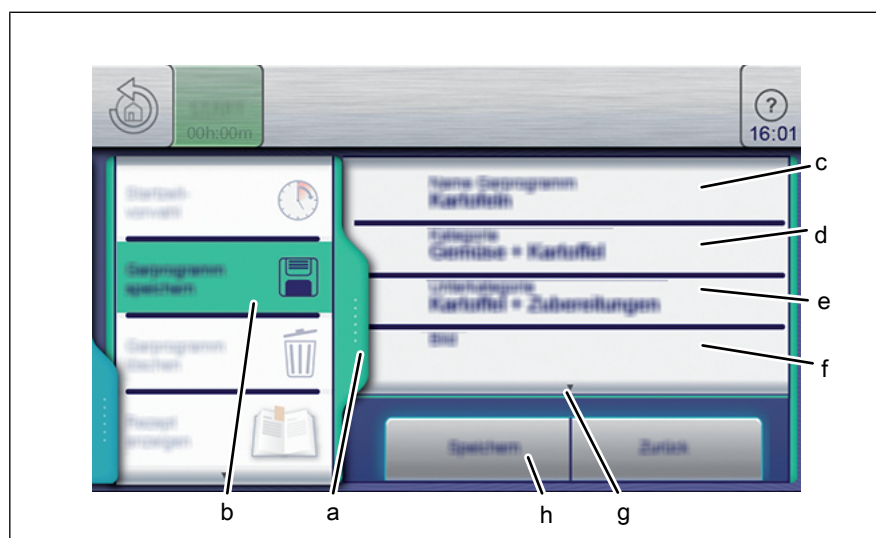

Image: Green tab and cooking program in the Save window

- |                                |                          |
|--------------------------------|--------------------------|
| a Green tab                    | e "Subcategory" field    |
| b "Save cooking program" field | f "Screen" field         |
| c "Cooking program name" field | g Next page arrow symbol |
| d "Category" field             | h "Save" button          |

### Requirement Cooking program is created and displayed

1. Tap the *Green* tab.
    - ↳ The *Tab* window opens.
  2. Tap the "Save cooking program" field.
    - ↳ The *Save* window opens.
- ↳ Save after making the entries.

### **Saving the cooking program name**

1. Tap the "Cooking program name" field.
  - ↳ The *Keypad* menu is displayed.
2. Views the keys to enter the desired program name.
3. Tap the *Confirm* button.
  - ↳ The *Keypad* menu closes.
  - ↳ The program name is displayed in the *Save* window.

### **Entering a category**

1. Tap the "Category" field.
  - ↳ The *Automatic cooking (autoChef)* menu is displayed.
2. Tap the field with the desired *Category*.
  - ↳ The category is set.
  - ↳ The *Automatic cooking (autoChef)* menu closes.
  - ↳ The category is displayed in the *Save* window.

### **Entering a subcategory (optional)**

1. Tap the "Subcategory" field.
  - ↳ The *Subcategory* menu is displayed.
2. Tap the field with the desired *Subcategory*.
  - ↳ The subcategory is set.
  - ↳ The *Subcategory* menu closes.
  - ↳ The subcategory is displayed in the *Save* window.

### **Assigning an image (optional)**

1. Tap the "Image" field.
  - ↳ The *Image* menu is displayed.
2. Select a photo by tapping it.
3. Select the location to save the photo.
4. Tap the "Photos in unit" button or the "Photos on USB flash drive" button.
  - ↳ The photo is selected.
  - ↳ The *Image* menu closes.
  - ↳ The name of the photo is displayed in the *Save* window.

### Assigning a recipe (optional)

1. Tap the "Recipe" field.
  - ↳ The *Recipe* menu is displayed.
2. Tap the "Empty recipe" field.
3. Select the save location.
4. Tap the "Recipes in unit" button or the "Recipes on USB flash drive" button.
  - ↳ The recipe is set.
  - ↳ The *Recipe* menu closes.
  - ↳ The name of the recipe is displayed in the *Save* window.

### Selecting favourites (optional)

1. Tap the "Show favourites" field.
  - ↳ The *Show favourites* menu is displayed.
2. Tap the "Yes" button or the "No" button.
  - ↳ Tapping Yes displays the cooking program in the Favourites menu.

### Selecting characteristics of the food to be cooked (optional)

1. Tap the "Frozen food" field.
  - ↳ The *Frozen food* menu is displayed.
2. Tap the "Yes" button or the "No" button.
  - ↳ Tapping Yes selects the food to be cooked as a frozen food.

### Assigning an identification (optional)

1. Tap the "Identification" field.
    - ↳ The *Identification* menu is displayed.
  2. Key in the barcode on the keypad.
- or
3. Scan with the barcode scanner.
    - ↳ Scan the barcode and assign to a cooking program or to food to be cooked.

### Selecting QualityControl

1. Tap the "QualityControl" field.
    - ↳ The *QualityControl* menu is displayed.
  2. Tap the "No" button.
    - ↳ QualityControl is deactivated for the cooking program.
  3. Tap the "Yes" button.
    - ↳ Tapping Yes sets the cooking program for a minimal amount of food to be cooked.
- ↳ QualityControl automatically adjusts the cooking time for a larger charge.

### Selecting SES

1. Tap the "SES" field.
  2. Tap the "No" button.
    - ↳ SES is switched off for the cooking program.
  3. Tap the "Yes" button.
    - ↳ With "Yes" the SES function is automatically activated shortly before the end of cooking.
- ↳ SES automatically adjusts itself in the case of cooking programs with a cooking time of more than 6 minutes.

### Assigning a video (optional)

1. Tap the "Video" field.
  - ↳ The *Video* menu is displayed.
2. Select the video by tapping it.
3. Select the location to save the photo.
4. Tap the button for "Videos in unit" or "Videos on USB flash drive".
  - ↳ Video is selected.
  - ↳ The *Video* menu is closed.
  - ↳ The name of the video is displayed in the Save window.

### 4.9.3 Exporting a cooking program



The USB port on the left is for the top Combisteamer; the USB port on the right is for the bottom Combisteamer.



Previously exported cooking programs on the USB flash drive will be overwritten.

**Requirement** Cooking program open  
Cooking program saved  
USB flash drive inserted

1. Tap the *Green* tab.
  - ↳ The *Tab* window opens.
2. Tap the "Export cooking programs" field.
  - ↳ The *Operating instructions* window opens.

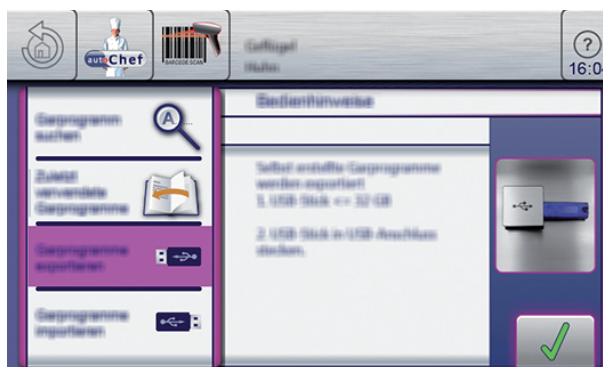

3. Read the displayed operating instructions.
  4. Tap the *Confirm* button.
    - ↳ The cooking program is exported to the USB flash drive.
    - ↳ The *Confirm* window is displayed.
  5. Tap the *Confirm* button.
    - ↳ The *Green tab* window closes.
- ↳ The cooking program is exported.

### 4.10 Automatic cooking (autoChef)

In the "Automatic cooking" mode, all cooking programs stored in the unit are available. The cooking program is selected in the *Automatic cooking* menu.

### 4.10.1 Opening the Automatic cooking menu

**Requirement** The unit is on  
The main menu is displayed

→ Tap the "Automatic cooking" button.

↳ The *Automatic cooking (autoChef)* menu is displayed.

### 4.10.2 Finding and opening a cooking program

#### Finding and opening a cooking program by category

Cooking programs can be found in the *Automatic cooking* menu by category and subcategory.



Arrow symbols in a window always display the next or previous page. A wiping gesture upward or downward opens the corresponding window.

---

**Requirement** The unit is switched on  
Main menu is displayed

1. Tap the "Automatic cooking" button.

↳ The *Automatic cooking* menu is displayed.

2. Tap the field with the desired category.

↳ The Subcategory menu is displayed.

3. Tap the field with the desired subcategory.

↳ The Recipe menu with all recipes in the subcategory is displayed.

4. Tap the field with the desired recipe.

↳ The cooking program is selected and being loaded.

↳ The cooking program steps are displayed.

↳ The cooking program opens.

### Finding and opening a cooking program in the cookbook

All cooking programs are saved in the cookbook in alphabetical order.

**Requirement** The unit is switched on  
Main menu is displayed

1. Tap the "Automatic cooking" button.
  - ↳ The Category menu is displayed.
2. Tap the "autoChef" button in the information bar.
  - ↳ The *autoChef* window is displayed.



3. Tap the *Find cooking program* field.
    - ↳ The *Find* window is displayed.
  4. Using the keypad, enter the letters for the name to be found.
    - ↳ A filtered list is displayed in the *Results* window.
  5. Tap the field with the name found.
    - ↳ The cooking program is selected and being loaded.
    - ↳ The cooking program steps are displayed.
- ↳ The cooking program opens.

#### 4.10.3 Starting the cooking program



The current step in the cooking program is highlighted. Upon completion, the following step automatically appears in the display.

**Requirement** Cooking program open

1. Tap the "START" button in the information bar.
    - ↳ The cooking program starts.
    - ↳ The "START" button in the information bar changes to the "STOPP" button.
    - ↳ The remaining cooking program time is displayed in the "STOPP" button.
- ↳ The cooking program is started.

### 4.10.4 Ending the cooking program

**Requirement** Cooking program started  
Cooking program time has not elapsed

1. Tap the "STOPP" button in the information bar.
- or
2. Wait for the cooking time to end.
    - ↳ Cooking program has ended.
    - ↳ The "STOPP" button in the information bar changes to the "START" button
- ↳ The cooking program has ended.



If the cooking zone door is not opened, the fan continues to run at a low speed at intervals. This achieves even cooking.

---



If the current cooking process is stopped manually, a window appears under certain circumstances with *Cooking program has been interrupted*.

You then have the opportunity to end or continue the cooking program.

---

### 4.10.5 Modifying the cooking program



Tabs available only within cooking programs or the cooking step display. Tapping the tabs provides faster access to their functions.

---



The current step in the cooking program is highlighted and can be modified. All settings of a step can be modified.

---



After the settings are made, the modified cooking program can be saved. The cooking program is overwritten if a new cooking program name is not specified.

---



**Modifying a cooking program after the program has started**

**Requirement** Cooking program started  
Cooking program has not elapsed

1. Modify the settings for the current step.
    - ↳ The modifications to the step become active immediately.
    - ↳ The modifications to the step are displayed.
  2. Tap the "Continue" field.
    - ↳ The active step is being ended.
    - ↳ The next step is being started.
    - ↳ The steps advance in the *Settings* window.
- ↳ The cooking program is modified.

**Modifying a cooking program before the program has started**

**Requirement** Cooking program open  
Cooking program not started

1. Modify various steps.
  2. Use a wiping gesture to reach the individual step to be modified.
  3. Modify the settings for the step.
    - ↳ The modifications of the step are displayed.
    - ↳ The cooking program can be started without being saved.
    - ↳ If the modifications are to be saved, continue with the next step.
  4. Tap the *green* tab.
    - ↳ The *Tab* window is open.
  5. Save the cooking program.
    - ↳ All modifications to the cooking program are saved.
- ↳ The saved cooking program is modified.

### 4.10.6 Deleting a cooking program

**Requirement** Cooking program open  
Cooking program not started

1. Tap the *Green* tab.
2. The *Tab* window opens.
3. Tap the "Delete cooking program" field.  
↳ The *Delete* window is displayed.

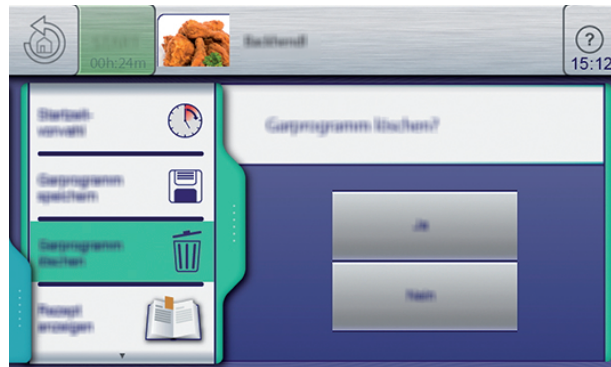

4. Tap the "Yes" button.  
↳ The cooking program is being deleted.  
↳ The *Confirm* window is displayed.
5. Tap the *Confirm* button.  
↳ The *Green* tab closes.  
↳ The cooking program is deleted.

### 4.10.7 Exporting and importing a cooking program



The USB port on the left is for the top Combisteamer; the USB port on the right is for the bottom Combisteamer.

#### Exporting cooking programs

When being exported, all user-created cooking programs in the Cookbook are exported.



Previously exported cooking programs on the USB flash drive will be overwritten.

**Requirements** USB flash drive inserted  
*Automatic cooking* menu open  
 User-created cooking programs are saved in the cookbook

1. Tap the "autoChef" button in the information bar.
  - ↳ The *autoChef* window opens.
2. Tap the "Export cooking programs" field.
  - ↳ The *Operating instructions* window opens.
  - ↳ Read the displayed operating instructions.



3. Tap the *Confirm* button.
    - ↳ All user-created cooking programs are exported to the USB flash drive from the cookbook.
    - ↳ The *Confirm* window is displayed.
  4. Tap the *Confirm* button.
    - ↳ Close the *Confirm* window.
- ↳ The cooking programs are exported.

### Importing cooking programs

When being imported, new cooking programs are added to the Cookbook.



Existing cooking programs can be overwritten or the file names of the imported cooking programs can have a supplement added.

---

**Requirements** USB flash drive inserted  
Automatic cooking menu open.

1. Tap the "autoChef" button in the information bar.  
↳ The *autoChef* window opens.
2. Tap the "Import cooking programs" field.  
↳ The *Operating instructions* window opens.  
↳ Read the displayed operating instructions.



3. Tap the *Confirm* button.  
↳ All cooking programs on the USB flash drive are imported to the cookbook.  
↳ The *Operating instructions* window is displayed.
4. Tap the "OK" button.  
↳ The cooking programs are imported.

## 4.11 VideoAssist

### 4.11.1 Watching a video

**Requirement** Videos saved on the unit.

1. Open the *Equipment function* menu.
2. Open the *Display videos* menu.

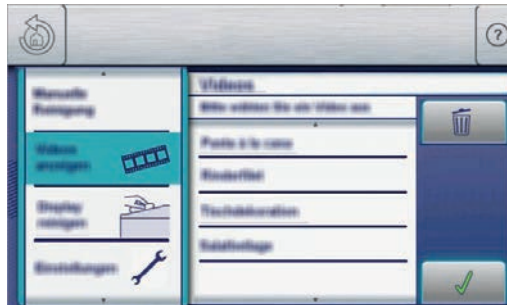

3. Select the video by tapping it.
  4. Tap the *Confirm* button.
- ↳ The video is played.

### 4.11.2 Deleting a video

**Requirement** The *Display videos* menu is open.

1. Tap the *Delete* field.
  - ↳ The *Delete* field becomes dark.
2. Tap the videos to be deleted.
  - ↳ The *Delete* symbol appears behind the designation of the video.
  - ↳ If you tap again on the video, the selection deletes this video.



3. Touch the *Confirmation* field.
- ↳ The marked videos are deleted.

### 4.12 Pausing and finishing use

Switch off the unit during pauses and at end of use.

#### 4.12.1 Perform a hygiene flush after an extended period of idleness

For reasons of hygiene, flush the water lines in the unit and on-site water lines before using the unit.

##### **Pause in operation lasting more than 2 days**

**Requirement** GN Containers, baking trays and Grates removed from the cooking zone

No food in the cooking chamber

1. Operate the hand shower for 1 minute.
2. Run the "Steaming" cooking mode for 7 minutes at . 100 °C.

##### **Production stops of more than 7 days**

**Requirement** GN Containers, baking trays and Grates removed from the cooking zone

No food in the cooking chamber

1. Operate the hand shower for 5 minutes.
2. Run the "Steaming" cooking mode for 1 hour at . 100 °C.

## 5 Cleaning and caring for the unit



### CAUTION

#### Risk of burns from hot surfaces

- Allow surfaces to cool prior to cleaning.



### CAUTION

#### Risk of chemical burns from cleaning agent

- Follow the instructions of the cleaning agent manufacturer.
- Take appropriate protective measures when handling aggressive cleaning agents.

### ATTENTION

#### Risk of physical damage from extremely abrupt cooling

- Do not cool shock the unit by cooling it abruptly.

### ATTENTION

#### Risk of physical damage from improper cleaning

- Do not clean the unit with a high-pressure cleaner or water jet.

### Cleaning traffic light and cleaning reminder

For units with automatic cleaning, a cleaning traffic light is displayed in the main menu in the "WaveClean" button.

Depending on the use and degree of soiling of the unit, the cleaning traffic light changes the traffic light phase.

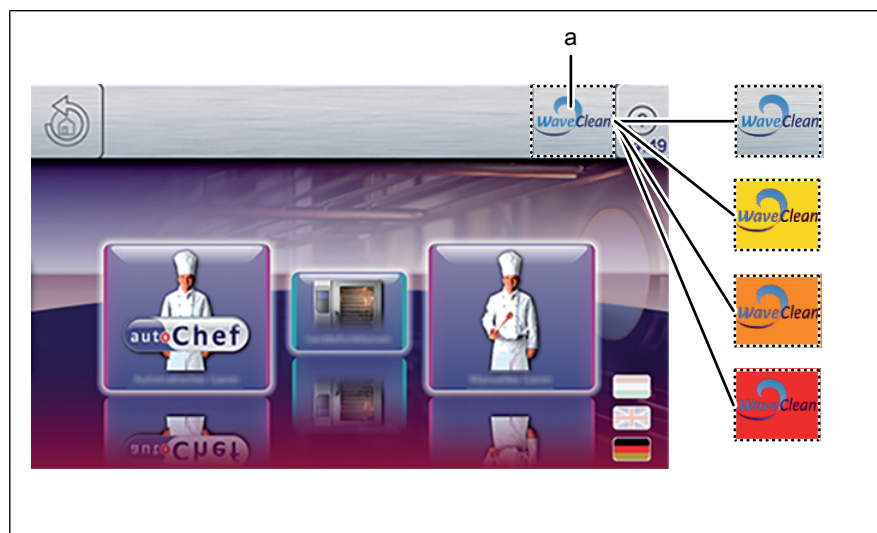

Image: Main menu

- a "WaveClean" button with cleaning traffic light

From the red light phase, the unit displays a cleaning reminder. The unit can continue to be used, but if it is not cleaned, the cleaning reminder will appear more frequently.

Traffic light phase	Explanation
grey	Pollution level low
yellow	Pollution level medium
orange	Pollution level high
Red	Pollution limit reached 1. Warning level: Cleaning reminder is displayed each time the device is started 2. Warning level: Cleaning reminder is displayed after each end of cooking process 3. Warning level: Cleaning reminder is displayed after each end of cooking process and acoustic signal sounds

### 5.1 Preventing corrosion

- Keep the surfaces of the unit clean and with access to air.
- Remove lime, grease, starch and protein deposits from the surfaces of the unit.
- Remove salt accumulations.
- Only expose parts made from non-rusting steel to brief contact with highly acidic foods, spices, salts or the like.
- Avoid damaging the stainless steel surface with other metal items, such as for example steel spatulas or steel wire brushes.
- Avoid contact with iron and steel, such as for example steel wool and steel spatulas.
- Do not use bleaching or chlorine-containing cleaning agents.
- Clean the contact surfaces with water.

### 5.2 Remove rust spots

- Remove fresh rust spots immediately with a mild abrasive or fine sandpaper.
- Always remove rust spots completely.
- Expose treated areas to fresh air for at least 24 hours. During this time, do not allow any contact with greases, oils or foods so that a new protective layer can form.

### 5.3 Cleaning the housing

**Requirement** Unit switched off and cooled down

→ Clean the housing with warm water and commercially available washing-up liquid.



## 5.4 Cleaning the handle, operating elements and operating panel membrane

### ATTENTION

#### Risk of property damage from improper cleaning

- Do not clean the surface with highly abrasive or chemically aggressive cleaning agents.
- Do not clean the surface with highly abrasive sponges.

**Requirement** Both units disconnected from the power supply

→ Clean the door handle, operating elements and control panel with a damp cloth and commercially available detergent.

## 5.5 Cleaning the touchscreen

### ATTENTION

#### Risk of physical damage from improper cleaning

- Do not clean the touchscreen with highly abrasive or chemically aggressive cleaning agents.
- Do not clean the touchscreen with highly abrasive sponges.



A cleaning time of 10 seconds is provided. The touchscreen cannot be operated during this time.

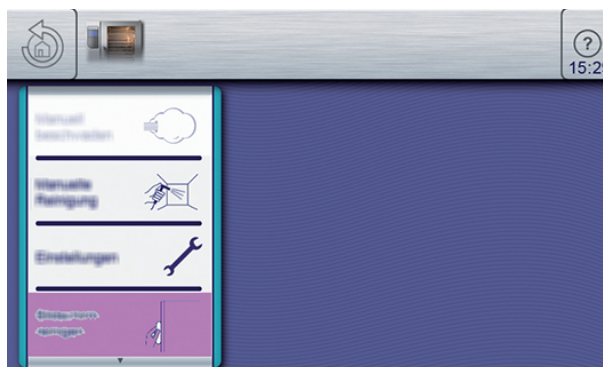

**Requirement** Equipment functions menu is displayed

1. Tap the "Clean touchscreen" field.
    - ↳ The touchscreen no longer reacts when touched.
    - ↳ The *Cleaning* window opens.
    - ↳ The cleaning time is updated.
  2. Clean the touchscreen within 20 seconds.
    - ↳ The Cleaning window closes.
    - ↳ The equipment functions menu is displayed.
- ↳ The touchscreen is clean.

### 5.6 Cleaning the door seal

---

#### **ATTENTION**

##### **Risk of physical damage from improper cleaning**

Animal fats in combination with high temperatures can damage the door seal very quickly if it is not maintained properly.

- Clean the door seal regularly.
  - Do not use aggressive cleaners.
- 



During automatic cleaning and semi-automatic cleaning, the outside surface of the door seal is not cleaned.

The door seal must be cleaned separately.

---



If the unit is used primarily for roasting, also clean the door seal during pauses in use.

---

→ When finished using the unit, clean the door seal with warm water and a commercially available detergent.

### 5.7 Cleaning the cooking zone door

---



#### **CAUTION**

##### **Risk of burns from hot surfaces**

- Allow surfaces to cool prior to cleaning.
- 

#### **ATTENTION**

##### **Risk of physical damage from improper cleaning of the surface**

- Do not use abrasive cleaners or cloths.
  - Do not use grill cleaners.
- 

→ Remove residual calcium deposits from the glass window with vinegar or citric acid.

## 5.8 Cleaning the steam outlet

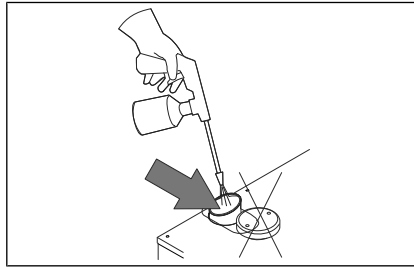

Image: Cleaning the steam outlet

### ATTENTION

#### Risk of physical damage from deposits

- Check the steam outlet and connected piping for deposits.



Use a liquid cleaner containing at most 20% sodium or potassium hydroxide.

Flushing with water is not necessary.

1. Examine the steam outlet and connected piping for deposits.
2. Spray liquid cleaner into the steam outlet.

## 5.9 Cleaning the condensation hood (optional)



### CAUTION

#### Risk of fire from dirt and grease accumulation

- Clean the hood after use.
- Follow the cleaning instructions.



### CAUTION

#### Risk of burns from hot surfaces

- Allow surfaces to cool prior to cleaning.



### CAUTION

#### Risk of injury from sharp edges

- Wear protective gloves.

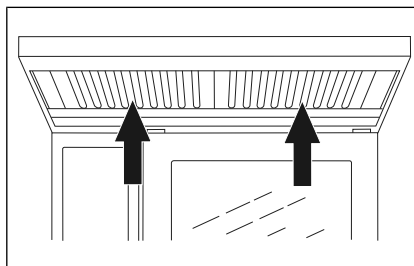

Image: Cleaning the condensation hood

**Requirement** Unit and hood disconnected from the electric mains  
Unit and hood cool

1. Clean the housing daily with warm water and a commercially available cleaner.
2. Push the grease filter upwards.
3. Pull the grease filter on the underside of the hood forward to remove it.
4. Clean the grease filter and hood with a commercially available cleaning agent.
5. Rinse and dry the grease filter, and replace it in the hood.

### 5.10 Removing calcium deposits from the unit

---



For manual descaling, fill commercially available descaler into manual spray gun.

---

**Requirement** Cooking zone temperature less than 40 °C  
Cooking zone cleaned

1. Fold open the air diverter.
2. Spray commercially available descaler into the cooking zone.
3. Allow to act for 30 minutes.
4. Rinse cooking zone thoroughly.
5. Examine the cooking zone for any remaining calcium deposits.
6. If necessary, repeat the decalcification.
7. Open the cooking zone door and leave it open with a slight gap until the unit is used again.
  - ↳ This extends the service life of the door seal.
  - ↳ No moisture builds up in the cooking zone.

### 5.11 Cleaning the cooking zone automatically with WaveClean

---



**CAUTION**  
**Risk of chemical burns**

Keep the cooking zone door closed during the cleaning procedure.

---



The use of unsuitable cleaning agents often causes damage to units. MKN makes great efforts to be able to offer a cleaning agent, which on the one hand achieves an outstanding cleaning performance, but which on the other hand does not attack and damage the convection steamer. We therefore recommend that only our cleaning agent is used. MKN does not assume any responsibility or liability for damage, which is caused by unsuitable cleaning agents. Claims against MKN that are due to this can not be upheld, not even within the scope of the guarantee or warranty.

---



It is not permitted to cool the temperature sensor down in order to start the cleaning procedure more quickly. The whole cooking zone must be cooled down to 60 °C for effective cleaning.

---



Depending on the cleaning level selected, the fan may be idle for up to 60 minutes. This is not a cancellation of the cleaning but part of the cleaning program.

---



Automatic forced rinse is triggered in the following situations.

- Cleaning is cancelled manually. Cancelling within the first 10 minutes of cleaning does not trigger an automatic forced rinse.
  - Cleaning is cancelled automatically in the event of a fault.
  - The Combisteamer is switched off and then back on during cleaning. The automatic forced rinse begins when the unit is switched back on.
- 



If the automatic forced rinse is cancelled, it starts again from the beginning.

It is not possible to start a cooking program, before the forced rinse is ended.

---

### 5.11.1 Preparing for cleaning

---

#### **ATTENTION**

#### **Risk of physical damage from improper cleaning**

- Do not clean the unit with a high-pressure cleaner or water jet.
- 

**Requirement** GN containers, baking sheets and grates removed from the cooking zone

1. Remove any food remains from the cooking zone.  
↳ The drain screen is not obstructed.
2. Leave only the support rack in the cooking zone.
3. Close the cooking zone door.

### 5.11.2 Selecting the cleaning level



If the water pressure falls during cleaning, the cleaning program reverts to maintenance status. When the water pressure is restored again, the cleaning program runs automatically.



Despite different cleaning times, all cleaning levels required the same amount of water.

#### Tip

In the case of automatic cleaning overnight, we recommend the "normal" or "extra" cleaning levels. This ensures that there is sufficient drying.

**Requirement** Unit switched on  
Main menu is displayed

1. Press the "WaveClean" button
2. Select the cleaning level.  
↳ *Operating instructions* window is displayed.
3. Tap the *Confirm* button.  
↳ The *Cleaning level selection* window is displayed.
4. Tap the "START STOPP" button.  
↳ If necessary, the cooking zone is cooled down until the cleaning temperature of 60 °C is reached.

### 5.11.3 Inserting the cleaning cartridge



Use only cleaning cartridges with an undamaged wax seal.

If the wax seal is damaged, the cleaner can enter the cleaning circuit prematurely or not dissolve completely, so that complete cleaning is no longer assured.

Insert the cleaning cartridges only when requested to do so.



Never operate the unit in the automatic cleaning mode without a cleaning cartridge.

If there is a high level of contamination, select the "extra" cleaning level and use 2 cleaning cartridges.

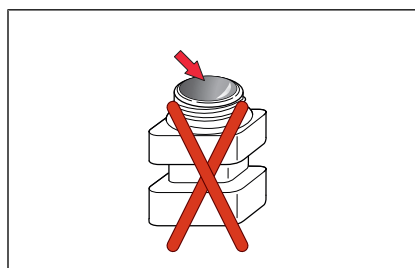

Image: Wax seal on the cleaning cartridge damaged

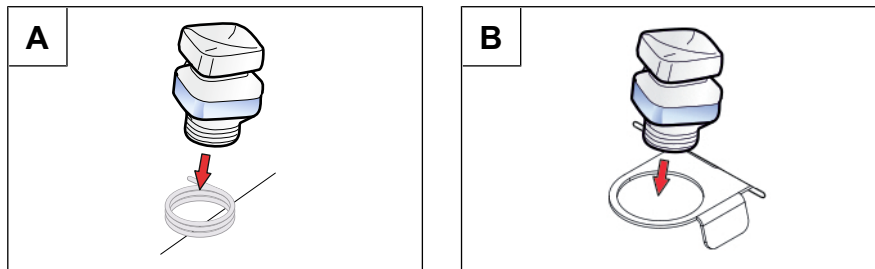

Image: A: Inserting the cartridge into the spring holder; B: Inserting the cartridge into the holder

**Requirements** Cleaning cartridge sealed and undamaged

1. Open the cooking zone door.
2. Open the lid of the cleaning cartridge.
3. Insert the cleaning cartridge into the holder on the air diverter.
4. Close the cooking zone door.

#### 5.11.4 Starting automatic cleaning

**Requirements** Water connection is open

The unit is on

Cleaning level selected

Cleaning cartridge inserted

Cooking zone temperature at 60 °C

→ Tap the "START STOPP" button.

↳ The display shows the remaining time.

#### 5.11.5 Cancelling automatic cleaning

1. Tap the "STOPP" button.

↳ Automatic cleaning is cancelled.

↳ Automatic rinsing starts and cannot be cancelled.

↳ Upon completion, a prompt appears to remove the cleaning cartridge.

2. Remove the cleaning cartridge.

### 5.11.6 Ending automatic cleaning



---

**CAUTION**  
**Risk of chemical burns**

Droplet quantities can contain caustic constituents, so suitable protective measures must be taken.

---

**Requirement** Automatic rinsing has stopped after the cleaning program was cancelled or the cleaning time has elapsed

1. Open cooking zone door.
2. Remove the empty cleaning cartridge.
3. Use the hand shower to thoroughly rinse out any remaining cleaner or rinsing agent.
4. Close cooking zone door.
  - ↳ After the cooking zone door is closed, the cleaning program is completed.
5. Flush away any droplets of cleaning water on the floor in front of the unit with a soft water jet.
6. Open the cooking zone door and leave it open with a slight gap until the unit is used again.
  - ↳ This extends the service life of the door seal.
  - ↳ No moisture builds up in the cooking zone.

## 5.12 Cleaning the cooking zone manually

### 5.12.1 Preparing the cooking zone

---

**ATTENTION**  
**Risk of physical damage from improper cleaning**

- Do not clean the unit with a high-pressure cleaner or water jet.
- 

**Requirement** GN containers, baking trays and grates removed from the cooking zone

1. Remove any food remains from the cooking zone.
  - ↳ The drain screen is not obstructed.
2. Leave only the support rack in the cooking zone in countertop units, and leave only the tray trolley in the cooking zone in floor-standing units.
3. Close the cooking zone door.

### 5.12.2 Starting the cleaning program

**Requirement** The unit is switched on

→ Tap Manual cleaning.



### 5.12.3 Spraying the cleaner



**CAUTION**  
**Dangerous situation**

Failure to observe precautions can result in slight to moderately severe injuries.

- Wear protective clothing.
- Wear breathing protection.

**ATTENTION**  
**Risk of physical damage from exceeding the recommended acting time of the cleaner**

- Do not allow the cleaner to act longer than specified by the program.

1. The menu field displays the instruction "Spray cleaner"
2. Put on protective clothing, safety goggles and protective gloves
3. Open cooking zone door.
4. Spray the cooking zone, heat register and fan wheel with cleaner.

### 5.12.4 Allowing the cleaner to act

- Close the cooking zone door.
  - ↳ The acting time starts.
  - ↳ The display shows the remaining time until the "Flush cooking zone" stage.

### 5.12.5 Starting cleaning

- The acting time has elapsed, the cleaning process starts automatically.
  - ↳ The cooking zone is heated.
  - ↳ The display shows the remaining time.

### 5.12.6 Rinsing the cooking zone

**Requirement** The cleaning process has completed

1. Open cooking zone door.
2. Using the hand shower, thoroughly rinse through the openings in the air diverter.
3. Thoroughly rinse the cooking zone with the hand shower for 3 minutes.
4. Close cooking zone door.

### 5.12.7 Drying the cooking zone

**Requirement** Cooking his own door closed

1. The drying process starts automatically.
- 



The cooking zone is heated.

---

2. After the end of the drying process, a signal sounds.  
↳ "End" appears on the display.
3. Open the cooking zone door and leave it ajar until the unit is used again.  
↳ This extends the service life of the door seal.  
↳ No moisture builds up in the cooking zone.

### 5.13 Swinging the air diverter open and closed

---



#### CAUTION

#### Pinch hazard from rotating fan

- Prior to working on the unit, ensure that the unit has been disconnected from the mains.
  - Do not operate the unit without the air diverter.
- 

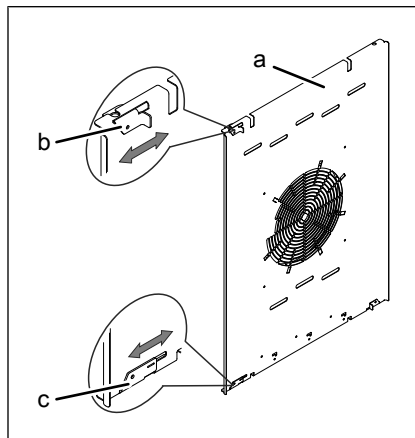

Image: Air diverter fastener

- a Air diverter
- b Top fastener
- c Bottom fastener

#### Swinging the air diverter open

**Requirements** Unit switched off

1. Remove the left support rack.
2. Release the top fastener.
3. Release the bottom fastener.
4. Swing the air diverter towards the rear wall.

### Swinging the air diverter back

1. Swing the air diverter back towards the side wall.
2. Close the top fastener.
3. Close the bottom fastener.
4. Check the fasteners.
5. Insert the left support rack.

## 5.14 Inspecting the unit

### 5.14.1 Performing a visual inspection

---

#### ATTENTION

#### Risk of physical damage from improper inspection

- Inspect in accordance with the inspection intervals.
  - Have inspections performed by a capable user.
  - In the event of damage or signs of wear, contact customer service immediately and stop using the unit.
- 

**Requirement** Unit disconnected from power  
Unit empty and cleaned  
Cooking zone door opened completely

→ Inspect housing, cooking zone door and cooking zone yearly for deformation and damage.

↳ Visual inspection has been performed.

## 5.14.2 Running CombiDoctor (self-diagnostic program)



Incorrect results are displayed when the unit is warm. Allow the unit to cool.

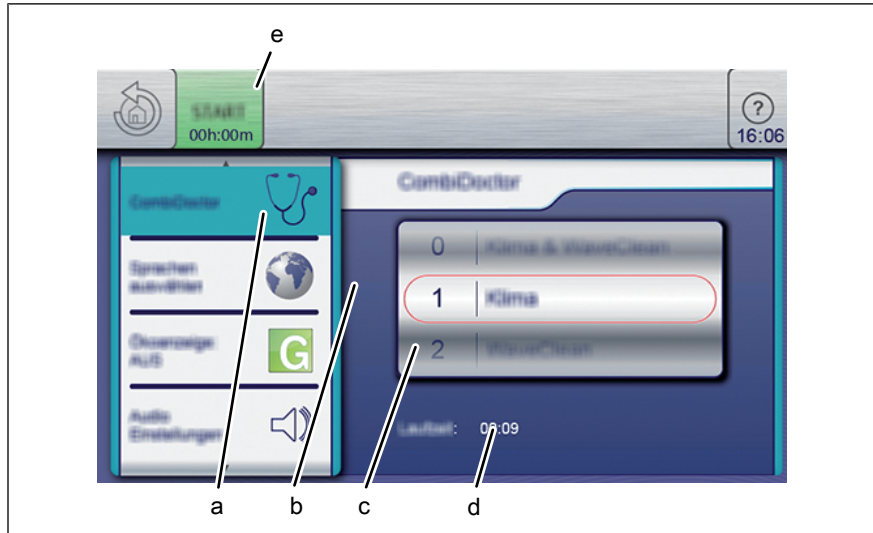

Image: Selecting the setting for self-diagnostic program

- |                     |                  |
|---------------------|------------------|
| a CombiDoctor field | d Remaining time |
| b Setting window    | e START button   |
| c Roller            |                  |

**Requirement** Water connection is opened

Power optimisation system deactivated (optional)

Cooking zone empty, no grates and no containers, with support rack or tray trolley

The unit is on

No errors displayed

Equipment functions displayed

1. Open the *Settings* menu.
  2. Enter the password.
  3. Tap the "CombiDoctor" field.
  4. Using a wiping gesture, set the roller to the desired self-diagnostic program.
    - ↳ The set self-diagnostic program displays the elapsed time.
  5. Press the "START" button.
    - ↳ A help text is displayed.
  6. Open the cooking zone door briefly and then close it.
    - ↳ The self-diagnostic program continues automatically.
- ↳ On completion of self-diagnosis, the result is displayed. Note the error message and forwarded to your local customer service.

## 6 Transporting the unit

**WARNING****Danger of tipping of the unit due to damaged castors**

If the castors are damaged, the unit may tip over and seriously injure you.

- Do not move the unit with the parking brakes tightened.
- Do not turn the castors with the parking brake applied.
- Do not kick against castors with the parking brake applied.
- Release the parking brake on the castors before moving the unit.
- Release the parking brake on the castors before moving the castors.

**WARNING****Danger of the unit tipping over on castors**

If the unit is tilted on castors, it may tip over and seriously injure you.

- Do not tip the unit on castors.

**CAUTION****Danger of the unit tipping over during transport**

When transporting the unit over inclined surfaces, thresholds or with the parking brake applied, the unit may tip over and injure you.

- Release the parking brake on the castors before transport.
- Move the device carefully on sloping surfaces or over thresholds.
- Set the parking brake of the castors again after transport.

**Requirement** GN Containers, baking trays and Grates removed from the cooking zone

Unit switched off

1. Disconnect the electrical connection cable.
2. Disconnect the water supply line.
3. Disconnect waste water connection.
4. Release the parking brakes.
5. Move the unit to another location.
6. Lock the parking brakes again.

# 7 Troubleshooting

If a fault occurs during operation, the error number and error message are displayed.

Use CombiDoctor to analyse the cause, if the cooking result or cleaning with WaveClean is different from that expected, and if an error message is not displayed.

## 7.1 Emergency mode



---

Emergency programs handle the limited further operation of the appliance until servicing. Deviating cooking results and temperature deviations are possible.

---

In order to allow limited use in case of error, the unit has several different emergency programs. Emergency operation is activated automatically and displayed. After elimination of the error indicated, the controls switch back into normal operation automatically. A reset is not necessary.

## 7.2 Causes of errors and remedies

Fault no.	Error message displayed	Description	Measure to be taken
694 695	<ul style="list-style-type: none"> <li>Cooking zone sensor is defective</li> </ul>	The internal core temperature sensor takes over the function of the defective cooking zone sensor.	<ul style="list-style-type: none"> <li>Insert the internal core temperature sensor into its holder.</li> <li>A different cooking result may occur.</li> <li>Contact Customer service.</li> </ul>
699 700 714 716	<ul style="list-style-type: none"> <li>Internal core temperature sensor is defective</li> </ul>	The internal core temperature sensor in the cooking zone is deactivated.	<ul style="list-style-type: none"> <li>If possible, use the external core temperature sensor (optional).</li> <li>Select another cooking program.</li> <li>Contact Customer service.</li> </ul>
710	<ul style="list-style-type: none"> <li>Vapour sensor defective</li> </ul>	Vapour elimination is now only controlled by the software. This results in higher water consumption.	<ul style="list-style-type: none"> <li>Contact Customer service</li> </ul>
	<ul style="list-style-type: none"> <li>Water pressure too low</li> </ul>	As permanent error message	<ul style="list-style-type: none"> <li>Open the water valve</li> <li>If the water valve is not closed, contact Customer service</li> </ul>
	<ul style="list-style-type: none"> <li>Water pressure too low</li> </ul>	As sporadic error message	<ul style="list-style-type: none"> <li>Activate fewer simultaneous water consumers in the kitchen.</li> <li>Contact Customer service</li> </ul>
	<ul style="list-style-type: none"> <li>No water in the waste trap</li> </ul>	The waste trap is not filled with sufficient water.	<ul style="list-style-type: none"> <li>Open the water valve</li> <li>2 l Pour water into the cooking zone</li> <li>If the error message persists, contact Customer service</li> </ul>
	<ul style="list-style-type: none"> <li>Unit restarted after a power failure</li> </ul>	If there was no power failure in the kitchen, it could be an operating error. An example of this would be unintentional switching on and off during a running cooking program.	<ul style="list-style-type: none"> <li>Power failure &lt; 1 minute</li> <li>Confirm the power failure message</li> <li>Continue with the cooking program</li> <li>No cleaning necessary</li> <li>Power failure &gt; 1 minute</li> <li>Cooking program cancelled</li> <li>Perform cleaning</li> </ul>
	<ul style="list-style-type: none"> <li>WaveClean cancelled</li> </ul>	<ul style="list-style-type: none"> <li>Please observe the explanations and notes in the chapter on "Automatic cleaning (WaveClean)"</li> </ul>	

## 7.3 Nameplate

When contacting Customer service, please always provide the following data from the nameplate:

Serial number (SN)	
Type number (TYP)	

# 8 Carrying out maintenance

The manufacturer recommends professional maintenance of the unit by trained technical personnel at maintenance intervals of 12 months. With heavier use, a maintenance interval of 6 months is recommended.



## 9 Dispose of unit in an environmentally responsible manner

The unit has been designed to provide a lifetime of 10 years with average use.



Do not dispose of unit or the unit's components together with non-recyclable waste. If the unit is disposed of together with non-recyclable waste or treated improperly, toxic substances contained in the unit can damage health and pollute the environment.

Dispose of the unit in accordance with local regulations for used appliances. Clarify any open questions with the responsible agencies (for instance, solid waste management).

We are a registered manufacturer at the **elektro-altgeräte** register foundation, and we are listed in the **ear** directory. If required, please contact one of the foundation's disposal agents. (WEEE-Reg.-Nr.DE 19459438)

**Unit** In addition to valuable materials, used electrical and electronic equipment also contains harmful substances that were needed for their operation and safety.

**Cleaning agents** Dispose of leftover cleaning agents and cleaning agent containers in accordance with the information provided by the cleaning agent's manufacturer. Observe applicable regional regulations.

**Residues from cooking** Residues from cooking and food must be collected in suitable containers and disposed of in accordance with the regionally applicable regulations.

# 10 Manufacturer's declaration



## EC Declaration of Conformity



**Manufacturer**

MKN Maschinenfabrik Kurt Neubauer GmbH & Co. KG • Halberstädter Straße 2a • 38300 Wolfenbüttel, Germany

We hereby declare, that the following product:

Description of the unit				
Unit for cooking food in commercial applications				
Unit type				
FlexiCombi electric combisteamer				
Type number				
MagicPilot	FKECOD115TXXXX	FKECOD121TXXXX	FKECOD215TXXXX	FKECOD221TXXXX
	FKECOD615TXXXX	FKECOD621TXXXX		
	DKECOD115TXXXX	DKECOD121TXXXX	DKECOD615TXXXX	DKECOD621TXXXX
Classic	FKECOD115CXXXX,	FKECOD121CXXXX	FKECOD215CXXXX	FKECOD221CXXXX
	FKECOD615CXXXX	FKECOD621CXXXX		
X: Equipment feature				

complies with all relevant provisions of the following Directives and Regulations. Furthermore, this declaration does not contain any assurance of characteristics or properties.

- Directive 2006/42/EC dated 17 May 2006 on machinery
- Directive 2011/65/EU (RoHS) dated 01 July 2011
- Directive 2014/30/EU dated 26 February 2014 on electromagnetic compatibility
- REGULATION (EC) No. 1935/2004 dated 27 October 2004 on materials and objects, which are intended to come into contact with food

Adduced basis for verification
EN ISO 12100:2010
DIN EN 55014-1:2006
EN 55014-2:1997 + Corrigendum 1997 + A1:2001 + A2:2008
EN 60335-1:2002 + A11:2004 + A1:2004 + A12:2006 + A2:2006 + A13:2008 + A14:2010 + A15:2012
EN 60335-2-42:2003 + A1:2008

The manufacturer bears the sole responsibility for issuing this Declaration of Conformity. This Declaration of Conformity becomes invalid, if changes are made which are not agreed with us.

Translation from the original document • 10013864-0KODE-E

Wolfenbüttel, 21/09/2022

Person authorised to compile the technical documents:

ppa. Peter Helm, Chief Technical Officer (address as manufacturer)





Declaration of Conformity



**Manufacturer**

MKN Maschinenfabrik Kurt Neubauer GmbH & Co. KG • Halberstädter Straße 2a • 38300 Wolfenbüttel, Germany

We hereby declare, that the following product:

Description of the unit				
Unit for cooking food in commercial applications				
Unit type				
FlexiCombi electric combisteamer				
Type number				
MagicPilot	FKECOD115TXXXX	FKECOD121TXXXX	FKECOD215TXXXX	FKECOD221TXXXX
	FKECOD615TXXXX	FKECOD621TXXXX		
	DKECOD115TXXXX	DKECOD121TXXXX	DKECOD615TXXXX	DKECOD621TXXXX
Classic	FKECOD115CXXXX,	FKECOD121CXXXX	FKECOD215CXXXX	FKECOD221CXXXX
	FKECOD615CXXXX	FKECOD621CXXXX		
X: Equipment feature				

complies with all relevant provisions of the following Directives and Regulations. Furthermore, this declaration does not contain any assurance of characteristics or properties.

- Directive 2006/42/EC dated 17 May 2006 on machinery
- Directive 2011/65/EU (RoHS) dated 01 July 2011
- Electromagnetic Compatibility Regulations 2016
- REGULATION (EC) No. 1935/2004 dated 27 October 2004 on materials and objects, which are intended to come into contact with food

Adduced basis for verification
EN ISO 12100:2010
DIN EN 55014-1:2006
EN 55014-2:1997 + Corrigendum 1997 + A1:2001 + A2:2008
EN 60335-1:2002 + A11:2004 + A1:2004 + A12:2006 + A2:2006 + A13:2008 + A14:2010 + A15:2012
EN 60335-2-42:2003 + A1:2008

The manufacturer bears the sole responsibility for issuing this Declaration of Conformity. This Declaration of Conformity becomes invalid, if changes are made which are not agreed with us.

Wolfenbüttel, 21/09/2022

Person authorised to compile the technical documents:

ppa. Peter Helm, Chief Technical Officer (address as manufacturer)





Declaration of Conformity



**Manufacturer**

MKN Maschinenfabrik Kurt Neubauer GmbH & Co. KG • Halberstädter Straße 2a • 38300 Wolfenbüttel, Germany

We hereby declare, that the following product:

Description of the unit				
Unit for cooking food in commercial applications				
Unit type				
FlexiCombi electric combisteamer				
Type number				
MagicPilot	FKECOD115TXXXX	FKECOD121TXXXX	FKECOD215TXXXX	FKECOD221TXXXX
	FKECOD615TXXXX	FKECOD621TXXXX		
	DKECOD115TXXXX	DKECOD121TXXXX	DKECOD615TXXXX	DKECOD621TXXXX
Classic	FKECOD115CXXXX,	FKECOD121CXXXX	FKECOD215CXXXX	FKECOD221CXXXX
	FKECOD615CXXXX	FKECOD621CXXXX		
X: Equipment feature				

complies with all relevant provisions of the following Directives and Regulations. Furthermore, this declaration does not contain any assurance of characteristics or properties.

- Directive 2006/42/EC dated 17 May 2006 on machinery
- Directive 2011/65/EU (RoHS) dated 01 July 2011
- Electromagnetic Compatibility Regulations 2016
- REGULATION (EC) No. 1935/2004 dated 27 October 2004 on materials and objects, which are intended to come into contact with food

Added basis for verification
EN ISO 12100:2010
DIN EN 55014-1:2006
EN 55014-2:1997 + Corrigendum 1997 + A1:2001 + A2:2008
EN 60335-1:2002 + A11:2004 + A1:2004 + A12:2006 + A2:2006 + A13:2008 + A14:2010 + A15:2012
EN 60335-2-42:2003 + A1:2008

The manufacturer bears the sole responsibility for issuing this Declaration of Conformity. This Declaration of Conformity becomes invalid, if changes are made which are not agreed with us.

Wolfenbüttel, 21/09/2022

Person authorised to compile the technical documents:

ppa. Peter Helm, Chief Technical Officer (address as manufacturer)



<b>A</b>		<b>L</b>	
After-cooking .....	20	Low-temperature cooking .....	18
Automatic cooking (autoChef)		<b>M</b>	
Cooking program, deleting.....	82	Main menu.....	21, 29
Cooking program, finding and opening.....	79	Manual cooking .....	68
Cooking program, modifying.....	81	Cooking program step, creating.....	68
Exporting cooking program.....	83	Cooking program, creating and saving .....	71
Importing cooking programs .....	84	Cooking program, exporting .....	77
Automatic forced rinse.....	93	<b>O</b>	
<b>B</b>		Operation locked .....	34
Basic settings, changing.....	30	<b>P</b>	
<b>C</b>		PerfectHOLD .....	18
ChefsHelp.....	19	<b>Q</b>	
Cleaning		QualityControl.....	20
Automatic cleaning (WaveClean) .....	94	<b>R</b>	
Cleaning cartridge (WaveClean).....	95	RackControl.....	19
Manual cleaning.....	96	Ready2Cook.....	18
Swinging the air diverter back.....	99	Recipes	
Swinging the air diverter open .....	98	Import recipes .....	40
ClimaSelect plus.....	20	Regenerate.....	17
Combisteaming .....	17	Resting time .....	20
Convection .....	17	<b>S</b>	
Core temperature measurement		Self-diagnosis (CombiDoctor) .....	100
4-point core temperature sensor		SES .....	19
measurement .....	65	Set cooking time .....	42
Set core temperature .....	44	Set fan .....	45
Standard setting value .....	24	Settings	
Core temperature sensor		Setting date and time .....	32
Core temperature measurement.....	21	Start-time preselection .....	19
<b>D</b>		Steaming .....	17
Delta-T cooking .....	17	<b>T</b>	
<b>E</b>		Temperature	
Environmentally friendly disposal .....	105	Cooking temperature, setting.....	41
Equipment information, calling up .....	32	Standard setting value .....	24
<b>F</b>		Time2Serve .....	20
FamilyMix .....	20	<b>U</b>	
Favourites, setting.....	34	USB .....	16, 63, 77, 83
FlexiRack.....	19	<b>V</b>	
<b>H</b>		Video	
HACCP.....	64	Import video .....	38
Humidification		Video, deleting .....	85
Manual .....	20		
<b>I</b>			
Images			
Importing images .....	39		





[www.mkn.com](http://www.mkn.com)

