

OPERATOR'S MANUAL

CT PROFORMANCE™

CTP6-10E

CTP6-10G

CTP10-10E

CTP10-10G

CTP7-20E

CTP7-20G

CTP10-20E

CTP10-20G

CTP20-10E

CTP20-10G

CTP20-20E

CTP20-20G



 **WARNING**

To prevent personal injury, death or property damage:



**Do not** store or use gasoline or other flammable vapors or liquids in the vicinity of this or any other appliance.

 **WARNING**

Improper installation, alteration, adjustment, service, cleaning, or maintenance could result in property damage, severe injury, or death.

Read and understand the installation, operating and maintenance instructions thoroughly before installing, servicing, or operating this equipment.



This manual covers the following CTP series models:

Boiler-Free Models	Steam Generator Models
6-10E, 6-10G	6-10EB
10-10E, 10-10G	10-10EB
7-20E, 7-20G	7-20EB
10-20E, 10-20G	10-20EB
20-10E, 20-10G	20-10EB
20-20E, 20-20G	20-20EB

Please post the following instructions in a prominent location in the event the user smells gas.

**DANGER**



Before starting the appliance, make certain you do not detect the odor of gas.

If you smell gas:

- Shut off the gas supply immediately.
- Do not attempt to light any appliance.
- Do not touch any electrical elements.
- Extinguish any open flame.
- Evacuate the area.
- Use a telephone outside the property and immediately contact your gas supplier.
- If unable to contact your gas supplier, contact the fire department.

## Enjoy your Alto-Shaam Combi Oven!

The combi oven combines a steam and convection oven into one versatile unit and can serve a variety of cooking functions. Alto-Shaam's combi ovens allow chefs to control humidity and temperature separately, with powerful results. The same oven can be used to dehydrate vegetables, roast pork, steam rice, smoke brisket and bake loaves of bread.

The PROtouch™ recipe management system with one-touch cooking provides complete control over the oven, allowing chefs and foodservice employees to select pre-programmed recipes for

maximum consistency. To store and secure important information, a HACCP data system pairs up with an onboard USB port, so settings can be downloaded and saved for the future.

When it's time to clean up, Alto-Shaam's CombiClean Plus™ automated cleaning system saves labor previously spent scrubbing the oven cavity. On the oven's exterior, a PROrinse™ retractable hose gives you spray-washing power without opening the oven door.

## Before Use

If this is the first time this oven is being used, or if the oven has just been removed from storage, follow these steps for cleaning:

1. Remove all packing material from the oven,
2. Remove and wash any detachable items such as wire shelves, side racks, pans, and drip trays with hot, soapy water. Dry with a clean, damp lint-free cloth.
3. Remove all visible grease or oil from the oven.
4. Clean the interior and exterior of the oven with a mild soap and water solution. Apply the solution with a clean, damp cloth. Do not use commercial or household cleaners that contain ammonia. Wipe with a clean, damp cloth to remove all detergent residue. Dry with a clean, lint-free cloth.

5. Clean the oven glass with glass cleaner or distilled vinegar. Re-install the side racks and wire shelves – position shelves with the curved end up and toward the rear of the oven.

When cleaning is complete, the oven must acclimate to room temperature in the environment where it is placed. Twenty four (24) hours is recommended.

The oven is now ready for operation.

# EXTEND YOUR ORIGINAL MANUFACTURER'S WARRANTY

## Register online today at [www.alto-shaam.com/warranty](http://www.alto-shaam.com/warranty)

Register your Alto-Shaam appliance online, and you will automatically be entered into a monthly drawing to win an additional year extended warranty!

Registering your equipment ensures prompt service in the event of a warranty claim. You will also receive direct notifications of software updates and additional product information.

Your personal information will not be shared with any other company.

## ALTO-SHAAM 24/7 EMERGENCY REPAIR SERVICE

Call 800-558-8744 to reach our twenty-four hour emergency service call center for immediate access to local authorized service agencies outside standard business hours. The emergency service access is provided exclusively for Alto-Shaam equipment and is available throughout the United States through Alto-Shaam's toll free number.

Emergency service access is available seven days a week, including holidays.



<b>Introduction</b> .....	<b>3</b>	Recipe Programming .....	39
<b>Table of Contents</b> .....	<b>5</b>	Using Programmed Recipes .....	40
<b>Safety Procedures</b> .....	<b>6</b>	To Cook with Preprogrammed Recipes .....	40
<b>Labels</b> .....	<b>9</b>	Editing Programmed Recipes .....	41
<b>Operation</b> .....	<b>16</b>	Organizing Programmed Recipes .....	42
How To Turn On the Oven .....	16	HACCP Access .....	44
How To Start a Manual Calibration .....	16	HACCP Access and Download .....	45
How To Calibrate the Touch Screen .....	16	<b>Options</b> .....	<b>46</b>
How To Turn Off the Oven .....	16	CombiHood PLUS™ Ventless Hood .....	46
Control Panel Identification .....	17	How To Use the Combilatch™ Door Interlock .....	47
Home Screen .....	17	Special Conditions for Units Installed in the City of New York ..	48
Utility Screen .....	17	Connecting the Optional Grease Collection System .....	49
Upload/Download Screen .....	17	Connecting the Optional Liquid Cleaner .....	50
Setting Screen 1 .....	18	<b>Recipe Guidelines</b> .....	<b>51</b>
Setting Screen 2 .....	18	Bakery Items .....	51
Preventative Maintenance Screen .....	19	Convenience Product Items .....	53
Preventative Maintenance - Editing .....	19	Fish & Seafood Items .....	54
Software Updates .....	20	Meat Recipes .....	55
Cooking Screen Identification .....	21	Miscellaneous Recipes .....	57
Auxiliary Functions and Features .....	22	Poultry Recipes .....	58
Power Settings .....	22	Vegetable Recipes .....	60
Multiple Fan Speeds .....	22	<b>Cleaning and Preventative Maintenance</b> .....	<b>62</b>
Multi-Shelf Timer .....	22	CombiClean® Cleaning Agents .....	62
Preheat Features .....	23	Preventive Maintenance .....	63
Cool Down Feature .....	23	Weekly Maintenance .....	64
Humidity Control Feature .....	24	Daily Inspection .....	65
Rapid Cool .....	24	Weekly Inspection .....	66
Rest .....	24	Monthly Inspection .....	67
Door .....	24	Yearly Inspection .....	68
Factory Default Settings .....	25	Protecting Stainless Steel Surfaces .....	71
Cooking Modes - Steam .....	26	Cleaning Agents .....	71
Steam Mode Operating Tips .....	27	Cleaning Materials .....	71
Cooking Modes - Combination .....	28	Daily Cleaning of the Over .....	72
Combination Mode Operating Tips .....	29	Probe and Probe Prong Cleaning .....	72
Cooking Modes - Convection .....	30	Roll-In Cart/Food Trolley Cleaning .....	72
Convection Mode Operating Tips .....	31	CT PROtouch™ with CombiClean® .....	73
Cooking Modes - Retherm .....	32	CT PROtouch™ with Automatic Liquid Cleaning .....	74
Retherm Mode Operating Tips .....	33	<b>Troubleshooting</b> .....	<b>75</b>
Cooking Modes - Dehydration .....	34	Error Codes .....	75
Dehydration Mode Operating Tips .....	35	Touch Motor Control Error Codes .....	81
Cooking Modes - Delta-T Core Temperature .....	36	<b>Limited Warranty</b> .....	<b>83</b>
CombiSmoker® Procedures .....	37		

- The appliance is intended to cook, hold or process foods for the purpose of human consumption. No other use for this appliance is authorized and is therefore considered dangerous. The appliance must not be used to cook food containing flammable materials (such as food with alcohol). Substances with a low flash point can ignite spontaneously and cause a fire.
- The appliance is intended for use in commercial establishments where all operators are familiar with the purpose, limitations, and associated hazards of this appliance. Operating instructions and warnings must be read and understood by all operators and users. Alto-Shaam recommends regular staff training to avoid the risk of accident or damage to the appliance. Operators must also receive regular safety instructions.
- Any troubleshooting guides, component views, and parts lists included in this manual are for general reference only and are intended for use by qualified and trained technicians.
- This manual should be considered a permanent part of this appliance. This manual and all supplied instructions, diagrams, schematics, parts lists, notices, and labels must remain with the appliance if the item is sold or moved to another location.

Knowledge of proper procedures is essential to the safe operation of electrically and/or gas energized equipment. The following signal words and symbols may be used throughout this manual.

## **DANGER**

Indicates a hazardous situation that, if not avoided, will result in death or serious injury.

## **WARNING**

Indicates a hazardous situation that, if not avoided, could result in death or serious injury.

## **CAUTION**

Indicates a hazardous situation that, if not avoided, could result in minor or moderate injury.

**NOTICE:** Indicates information considered important, but not hazard-related (e.g., messages relating to property damage).

**NOTICE:** For equipment delivered for use in any location regulated by the following directive: 2012/95/EC WEEE



**Do not** dispose of electrical or electronic equipment with other municipal waste.

- To prevent serious injury, death or property damage, the appliance should be inspected and serviced at least every twelve (12) months by an authorized service partner or trained technician.
- **Only** allow an authorized service partner or trained technician to service or to repair the appliance. Installation or repairs that are not performed by an authorized service partner or trained technician, or the use of non-factory authorized parts will void the warranty and relieve Alto-Shaam of all liability.
- When working on this appliance, observe precautions in the literature, on tags, on labels attached to or shipped with the appliance and other safety precautions that may apply.
- If the appliance is installed on casters freedom of movement of the appliance must be restricted so that utility connections (including gas, water, and electricity) cannot be damaged when the appliance is moved. If the appliance is moved, ensure that all utility connections are properly disconnected. If the appliance is returned to its original position, ensure that retention devices and utility connections are properly connected.
- **Only** use the appliance when it is stationary. Mobile appliance racks, mobile plate racks, transport trolleys, and appliances on casters can tip over when being moved over an uneven floor or threshold and cause serious injury.
- **Always** apply caster brakes on mobile appliances or accessories when these are not being moved. These items could move or roll on uneven floors and cause property damage or serious injury.
- Be extremely careful when moving appliances because the food trays may contain hot fluids that may spill, causing serious injury.
- **Always** open the appliance door very slowly. Escaping hot vapors or steam can cause serious injury or death.
- If the gas appliance is installed under an exhaust hood, the hood must be switched **On** when the appliance is in use to avoid the build up of combustion gases. Failure to do so may result in serious injury, death or property damage.
- Accumulations on the main burners of gas appliances can result in firing out of normal sequence. This delayed ignition creates an alarmingly loud sound. If your appliance makes an especially loud noise when starting up, shut down the appliance and call a qualified and trained service technician.
- NEVER place objects near the appliance exhaust vents. This area is hot and could be a potential ignition source for a fire.
- Do not allow objects to block or obstruct the area below the appliance base. This may result in fire, damage to the equipment or serious injury.
- Do not use the attached hand-held hose to spray anything other than the interior of the appliance compartment.
- Do not use the attached hand-held hose on the surface of a hot cooking compartment. The sudden temperature change can damage the appliance interior. Allow the appliance to cool to a minimum of 150°F (66°C). Failure to observe this precaution can void the warranty.

## WARNING



This appliance is not intended for use by persons (including children) with reduced physical, sensory or mental capabilities, or lack of experience and knowledge, unless they have been given supervision concerning use of the appliance by person responsible for their safety.

Children should be supervised to ensure that they do not play with the appliance.

**⚠ WARNING**

 To prevent serious personal injury, death, or property damage:  
**Do not** steam clean, hose down or flood the interior or exterior with water or liquid solution of any kind. **Do not** use water jet to clean. Failure to observe this precaution will void the warranty.

**WARNING**

 To prevent **SERIOUS PERSONAL INJURY** or **PROPERTY DAMAGE**:  
**DO NOT** handle pans containing liquid or semiliquid products positioned above the eye level of the operator. Such products may scald and cause serious injury.

**WARNING**

 **DO NOT** obstruct or block exhaust flues or attach any flue extension that may impede proper burner operation, restrict the exhaust fumes and cause negative backdraft or the appliance to shut down. Failure to do so may result in serious injury or death.

**⚠ WARNING**

 To prevent **serious personal injury, death, or property damage**:  
 The appliance must be cleaned thoroughly to avoid deposits of grease and or food residues inside the appliance that may catch fire. If fat deposits and/or food waste inside the appliance ignite, shut down the appliance immediately and keep the appliance door closed to extinguish the fire. If further extinguishing is required, disconnect the appliance from the main power and use a fire extinguisher (do not use water to extinguish a grease fire!). Failure to clean the appliance properly invalidates the warranty and relieves Alto-Shaam of all liability.

**⚠ CAUTION**

 To prevent **personal injury or property damage**:  
**Always** use hand protection when operating this appliance to avoid burns. Metal parts of this equipment become extremely hot when in operation.

**CAUTION**

 To prevent **INJURY** or **PROPERTY DAMAGE**, make certain the area around the appliance is kept clear of combustible items.





**NOTICE:** Automatic steam venting is a standard safety feature built into all Combitherm oven models. This feature vents all steam from the oven compartment immediately before cooking time expires or set probe temperature is reached.







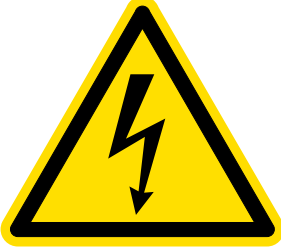







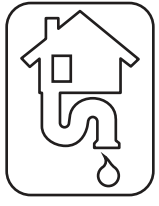

Automatic steam venting does not function if the oven door is opened before time expires or when the oven has been set to continuous operation.

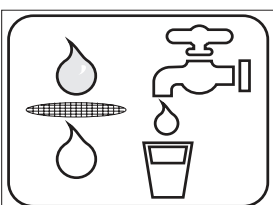
**NOTICE:** Use authorized Combitherm oven cleaner only. Unauthorized cleaning agents may discolor or harm interior surfaces of the oven. Read and understand label and material safety data sheet before using the oven cleaner.







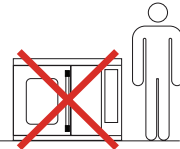
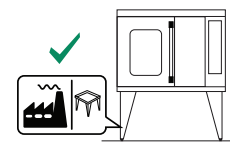
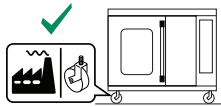
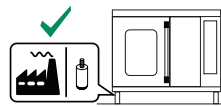

	<p>Made in U.S.A.</p>
	<p>WARNING Hot surface</p>
	<p>WARNING Electric shock hazard</p>
<div style="border: 1px solid black; padding: 5px;">  <p><b>⚠ WARNING / ADVERTENCIA / AVERTISSEMENT</b></p> <p>Burn hazard. Always load liquids, or foods that can become liquid when heated, at an eye level where they can be seen.</p> <p>Peligro de quemaduras. Siempre coloque líquidos, o alimentos que se puedan volver líquidos cuando se calientan, a nivel de los ojos donde se puedan ver.</p> <p>Risque de brûlure. Toujours charger les liquides, ou les aliments qui deviennent liquides au chauffage, à hauteur des yeux où ils peuvent être vus.</p> <p style="text-align: right; font-size: small;">LA-39123</p> </div>	<p>WARNING Burn hazard</p> <p>Always load liquids, or foods that can become liquid when heated, at an eye level where they can be seen.</p>
 <p style="text-align: right; font-size: x-small;">LA-39155</p>	
<div style="border: 1px solid black; border-radius: 15px; padding: 10px;"> <p style="text-align: center;"><b>ALTO-SHAAM.</b></p> <p>Every Alto-Shaam product is precision calibrated prior to release from the factory to ensure accurate temperature control.</p> <p>CALIBRATION TECHNICIAN _____</p> <p style="font-size: x-small;">LA-26378</p> </div>	<p>Every Alto-Shaam product is precision calibrated prior to release from the factory to ensure accurate temperature control.</p>

 <p>LA-36443-L1</p>	Line 1 supply terminal
 <p>LA-36443-L2</p>	Line 2 supply terminal
 <p>LA-36443-L3</p>	Line 3 supply terminal
 <p>LA-36443-L2/N</p>	Neutral
 <p>LA-36443-G</p>	Ground terminal
 <p>LA-36443-E</p>	Equipotential terminal
 <p>LA-38911</p>	Drain water connection point.
 <p>LA-38910</p>	Untreated, drinkable water connection point.
 <p>LA-38909</p>	Treated, drinkable water connection point.

<div style="display: flex; align-items: center; justify-content: space-around;">  </div> <table border="1" style="width: 100%; border-collapse: collapse; text-align: center;"> <thead> <tr> <th></th> <th>Σ kg max.</th> <th>Σ liter max.</th> <th>Σ GN 1/1</th> </tr> </thead> <tbody> <tr> <td>6-10</td> <td>33</td> <td>57</td> <td>6</td> </tr> <tr> <td>10-10</td> <td>54</td> <td>95</td> <td>10</td> </tr> <tr> <td>7-20</td> <td>76</td> <td>133</td> <td>14</td> </tr> <tr> <td>10-20</td> <td>109</td> <td>190</td> <td>20</td> </tr> <tr> <td>20-10</td> <td>109</td> <td>190</td> <td>20</td> </tr> <tr> <td>20-20</td> <td>218</td> <td>380</td> <td>40</td> </tr> </tbody> </table> <p style="text-align: right; font-size: small;">LA-38940</p>		Σ kg max.	Σ liter max.	Σ GN 1/1	6-10	33	57	6	10-10	54	95	10	7-20	76	133	14	10-20	109	190	20	20-10	109	190	20	20-20	218	380	40	<p>Capacities</p>
	Σ kg max.	Σ liter max.	Σ GN 1/1																										
6-10	33	57	6																										
10-10	54	95	10																										
7-20	76	133	14																										
10-20	109	190	20																										
20-10	109	190	20																										
20-20	218	380	40																										
<div style="border: 1px solid black; padding: 5px;"> <div style="background-color: orange; color: white; padding: 2px; display: flex; align-items: center;"> <b>WARNING/ADVERTENCIA/AVERTISSEMENT</b> </div> <div style="display: flex; margin-top: 10px;"> <div style="flex: 1; padding-right: 10px;">  <p><b>Fire Hazard</b> This unit is only for use with factory-supplied legs, casters, or base.</p> </div> <div style="flex: 1; padding-right: 10px;">  <p><b>Peligro de incendio</b> This unit is only for use with factory-supplied legs, casters, or base.</p> </div> <div style="flex: 1;"> <p><b>Risque d'incendie</b> This unit is only for use with factory-supplied legs, casters, or base.</p> </div> </div> <p style="text-align: right; font-size: x-small;">LA-39335</p> </div>	<p>Fire hazard</p> <p>This unit is only for use with factory-supplied legs, casters, or base.</p> <p>Read the installation manual.</p>																												
<div style="border: 2px solid black; padding: 10px;"> <div style="display: flex; justify-content: space-between; align-items: center;">   </div> <div style="display: flex; justify-content: space-around; margin-top: 10px;"> <div style="text-align: center;">  </div> <div style="text-align: center;">  </div> </div> <div style="display: flex; justify-content: space-around; margin-top: 10px;"> <div style="text-align: center;">  </div> <div style="text-align: center;">  </div> </div> <p style="text-align: right; font-size: x-small;">LA-39336</p> </div>																													

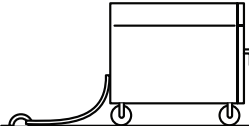
<div style="border: 1px solid black; padding: 5px;"> <div style="background-color: orange; color: white; padding: 2px; display: flex; align-items: center;"> <p><b>WARNING ADVERTENCIA AVERTISSEMENT</b></p> </div> <div style="display: flex; align-items: center; margin-top: 5px;"> <div> <p>Steam Open carefully.</p> <p>Vapor Abrir con cuidado.</p> <p>Vapeur Ouvrir avec précaution.</p> </div> </div> <p style="font-size: small; margin-top: 5px;">LA-39122</p> </div>	<p>Warning</p> <p>Steam. Open door carefully.</p>
<p style="font-size: x-small; text-align: center;">LA-39126</p>	
<div style="border: 1px solid black; padding: 5px;"> <div style="display: flex; align-items: center;"> <div style="background-color: orange; color: white; padding: 2px; display: flex; align-items: center;"> <p><b>WARNING ADVERTENCIA AVERTISSEMENT</b></p> </div> </div> <div style="margin-top: 5px;"> <p>Failure to follow cleaning instructions can cause injury or equipment damage. Clean oven only with Combitherm cleaner. Cleaner is caustic. Avoid contact with skin or eyes. Wear PPE. Read and understand the Combitherm cleaner safety data sheet and the operator's manual before cleaning.</p> <p>No seguir las instrucciones de limpieza puede provocar lesiones o daños al equipo. Limpie el horno solo con limpiador Combitherm. El limpiador es cáustico. Evite el contacto con la piel o los ojos. Use equipos de protección personal. Lea y comprenda la hoja de datos de seguridad del limpiador Combitherm y el manual del operador antes de la limpieza.</p> <p>Respecter les instructions de nettoyage pour écarter les risques de blessures ou de dégâts matériels. Nettoyer le four uniquement avec un produit nettoyant Combitherm. Le produit nettoyant est caustique. Éviter le contact avec la peau et les yeux. Porter un EPI. Lire et comprendre la fiche de données de sécurité du produit nettoyant Combitherm et le manuel de l'utilisateur avant de nettoyer.</p> <p style="font-size: x-small; text-align: right;">LA-22836</p> </div> </div>	<p>Warning</p> <p>Failure to follow cleaning instructions can cause injury or equipment damage. Clean oven only with Combitherm cleaner. Cleaner is caustic. Avoid contact with skin or eyes. Wear PPE. Read and understand the Combitherm cleaner safety data sheet and the operator's manual before cleaning</p>
<div style="border: 1px solid black; padding: 5px;"> <div style="display: flex; justify-content: space-around; align-items: center;"> </div> <div style="display: flex; justify-content: space-around; align-items: center; margin-top: 10px;"> </div> <p style="font-size: x-small; text-align: right;">LA-39149</p> </div>	

<div style="border: 1px solid black; padding: 5px;"> <div style="background-color: #f4a460; padding: 2px; text-align: center; font-weight: bold;"> <span style="color: white;">⚠</span> WARNING/ADVERTENCIA/AVERTISSEMENT         </div> <div style="display: flex; align-items: flex-start; padding: 5px;"> <div style="margin-right: 10px;">      </div> <div> <p><b>Electric Shock Hazard</b> Appliances with permanent electrical connection that are mounted on casters must be secured to building structure. Read installation instructions.</p> <p><b>Peligro de descarga eléctrica</b> Los equipos con una conexión eléctrica permanente que estén montados sobre ruedas deben estar fijos a la estructura del edificio. Lea las instrucciones de instalación.</p> <p><b>Risque d'électrocution</b> Les appareils à branchement électrique fixe qui sont montés sur roulettes doivent être attachés à la structure du bâtiment. Lire les instructions d'installation.</p> <p style="text-align: right; font-size: small;">LA-38912</p> </div> </div> </div>	<p>Warning</p> <p>Electric Shock Hazard</p> <p>Appliances with permanent electrical connection that are mounted on casters must be secured to building structure. Read installation instructions.</p>
<div style="border: 1px solid black; padding: 5px; text-align: center;">    <p style="text-align: right; font-size: small;">LA-39148</p> </div>	
<div style="border: 1px solid black; padding: 5px;"> <div style="background-color: #f4a460; padding: 2px; text-align: center; font-weight: bold;"> <span style="color: white;">⚠</span> WARNING/ADVERTENCIA/AVERTISSEMENT         </div> <div style="display: flex; align-items: flex-start; padding: 5px;"> <div style="margin-right: 10px;">      </div> <div> <p><b>WARNING:</b> Improper installation, adjustment, alteration, service or maintenance can cause property damage, injury or death. Read the installation, operating and maintenance instructions thoroughly before installing or servicing the equipment.</p> <p>Water and waste connection shall comply with the basic plumbing code of the Building Officials and Code Administrators International, Inc. (BOCA) and the Food Service Sanitation Manual of the Food and Drug Administration (FDA).</p> <p><b>ADVERTENCIA:</b> Una instalación, ajuste, modificación, reparación o mantenimiento inadecuado podría producir daños en el equipo, lesiones personales e incluso la muerte. Lea las instrucciones de instalación, funcionamiento y mantenimiento detenidamente antes de instalar o reparar el equipo.</p> <p>La conexión de agua y de aguas residuales debe cumplir el Código de Tuberías Básico (Basic Plumbing Code) de Building Officials y Code Administrators International, Inc. (BOCA), y el Manual de Sanidad de Servicio de Alimentos (Food Service Sanitation Manual) de la Administración de Drogas y Alimentos (FDA, por sus siglas en inglés).</p> <p><b>AVERTISSEMENT:</b> L'installation, le réglage, la modification, la réparation ou l'entretien incorrect de cet appareil peut causer des dommages matériels, des blessures ou la mort. Lire attentivement les instructions d'installation, de fonctionnement et d'entretien avant de procéder à son installation ou entretien.</p> <p>Le raccordement d'eau et d'évacuation doit être conforme au Basic Plumbing Code de BOCA (Building Officials and Code Administrators International, Inc.) et au Food Service Sanitation Manual de la FDA (Food and Drug Administration).</p> <p style="text-align: right; font-size: small;">LA-38908</p> </div> </div> </div>	<p>Warning</p> <p>Improper installation, adjustment, alteration, service or maintenance can cause property damage, injury or death. Read the installation, operating and maintenance instructions thoroughly before installing or servicing the equipment.</p> <p>Water and waste connection shall comply with the basic plumbing code of the Building Officials and Code Administrators International, Inc. (COCA) and the Food Service Sanitation Manual of the Food and Drug Administration (FDA).</p>

<div style="border: 1px solid black; padding: 5px;"> <div style="background-color: #f4a460; padding: 2px; display: flex; align-items: center;"> <b>WARNING/ADVERTENCIA/AVERTISSEMENT</b> </div> <div style="margin-top: 10px;"> <p><b>Fire Hazard</b> For use only on noncombustible surfaces. Maintain the correct clearances to combustibles.</p> <p><b>Peligro de incendio</b> Solo para uso en superficies no combustibles. Mantenga las distancias correctas de elementos combustibles.</p> <p><b>Risque d'incendie</b> Utilisation sur des surfaces non combustibles seulement. Maintenir des dégagements corrects par rapport aux matières combustibles.</p> <table border="1" style="width: 100%; border-collapse: collapse; margin-top: 10px;"> <thead> <tr> <th></th> <th>Combustibles</th> <th>Non-combustibles</th> </tr> </thead> <tbody> <tr> <td>Top/tope/haut</td> <td>20" (508mm)</td> <td>20" (508mm)</td> </tr> <tr> <td>Left/izquierda/gauche</td> <td>0" (0mm)</td> <td>0" (0mm)</td> </tr> <tr> <td>Right/derecho/droite</td> <td>2" (51mm)</td> <td>0" (0mm)</td> </tr> <tr> <td>Rear/posterior/arrière</td> <td>4" (102mm)</td> <td>4" (102mm)</td> </tr> </tbody> </table> <p style="text-align: right; font-size: small; margin-top: 5px;">LA-38906</p> </div> </div>		Combustibles	Non-combustibles	Top/tope/haut	20" (508mm)	20" (508mm)	Left/izquierda/gauche	0" (0mm)	0" (0mm)	Right/derecho/droite	2" (51mm)	0" (0mm)	Rear/posterior/arrière	4" (102mm)	4" (102mm)	<p>Warning</p> <p>Fire Hazard</p> <p>For use only on noncombustible surfaces. Maintain the correct clearances to combustibles.</p> <p>Read the installation instructions.</p>
	Combustibles	Non-combustibles														
Top/tope/haut	20" (508mm)	20" (508mm)														
Left/izquierda/gauche	0" (0mm)	0" (0mm)														
Right/derecho/droite	2" (51mm)	0" (0mm)														
Rear/posterior/arrière	4" (102mm)	4" (102mm)														
<div style="border: 1px solid black; padding: 5px;"> <p style="text-align: right; font-size: small; margin-top: 5px;">LA-38907</p> </div>																
<div style="border: 1px solid black; padding: 10px; text-align: center;"> <h2 style="margin: 0;">COA #5760</h2> <p style="font-size: x-small; margin-top: 5px;">LA-39312</p> </div>	<p>City of New York Fire Department condition of acceptance number.</p>															
<div style="border: 1px solid black; padding: 5px;"> <div style="background-color: #0056b3; color: white; padding: 5px; text-align: center; font-weight: bold; font-size: 1.2em;">                 NOTICE/AVISO/AVIS             </div> <p style="margin-top: 10px;">For trained personnel only: The installation manual and the wiring diagram for this appliance can be found inside the oven attached to the opposite side of this panel.</p> <p style="margin-top: 10px;">Solo para personal capacitado: El manual de instalación y el diagrama de cableado de este equipo se pueden encontrar dentro del horno, en el lado opuesto de este panel.</p> <p style="margin-top: 10px;">Personnel formé seulement : Le manuel d'installation et le schéma de câblage de cet appareil se trouvent à l'intérieur du four attachés de l'autre côté de ce panneau.</p> <p style="text-align: right; font-size: x-small; margin-top: 5px;">LA-38941</p> </div>	<p>Notice</p> <p>For trained personnel only: The installation manual and the wiring diagram for this appliance can be found inside the oven attached to the opposite side of this panel.</p>															
	<p>XXX</p>															

<div style="border: 1px solid black; padding: 5px;">  <div style="border: 1px solid black; padding: 2px; background-color: #f96; margin-bottom: 5px;"> <p><b>⚠ WARNING/ADVERTENCIA/AVERTISSEMENT</b></p> </div> <p><b>Electric Shock Hazard</b>          To reduce the risk of electric shock, do not remove or open cover. No user-serviceable parts inside. Refer servicing to qualified personnel.          Qualified personnel: Disconnect power before servicing.</p> <p><b>Peligro de descarga eléctrica</b>          Para reducir el riesgo de descarga eléctrica, no retire ni abra la cubierta. No hay piezas en el interior a la que se les pueda realizar mantenimiento. Derive el mantenimiento a personal calificado.          Personal calificado: Desconecte la energía antes de realizar mantenimiento.</p> <p><b>Danger de décharge électrique</b>          Pour réduire le risque de décharge électrique, ne par ouvrir ni retirer le capot. Ne contient pas de pièces réparables par l'utilisateur. Confier les réparations à du personnel qualifié.          Personnel qualifié : Sectionnez l'alimentation avant toute intervention.</p> <p style="text-align: right; font-size: small;">LA-38950</p> </div>	<p>Warning</p> <p>Electric shock hazard.</p> <p>To reduce the risk of electric shock, do not remove or open cover. No user-serviceable parts inside. Refer servicing to qualified personnel.</p> <p>Qualified personnel: Disconnect power before servicing.</p>
<div style="border: 1px solid black; border-radius: 10px; padding: 10px;"> <p>Use _____AWG for supply connections.          Use only copper wires suitable for temperatures <math>\geq 90^{\circ}\text{C}</math>.          Do not connect to a circuit operating at more than 150 VAC to ground.          For use on individual branch circuits only.</p> <div style="display: flex; align-items: center; justify-content: center; margin: 10px 0;"> <div style="border: 1px solid black; width: 30px; height: 30px; margin-right: 5px;"></div> <div style="text-align: center;"> <p><b>AWG</b> <b>90°C</b></p> </div> </div> <p>Use AWG _____ para las conexiones de suministro.          Use solo cables de cobre aptos para temperaturas mayores que <math>90^{\circ}\text{C}</math>.          No conecte a un circuito que funcione a más de 150 V CA a tierra.          Para su uso en circuitos derivados individuales solamente.</p> <p>Utiliser du calibre _____AWG pour les raccordements électriques.          Utiliser exclusivement des conducteurs en cuivre qui conviennent à des températures <math>\geq 90^{\circ}\text{C}</math>.          Ne pas raccorder à un circuit fonctionnant sous plus de 150 VCA par rapport à la terre.          Utiliser exclusivement sur des circuits de dérivation propres.</p> <p style="text-align: right; font-size: small;">LA-38852</p> </div>	<p>Use _____AWG for supply connections.</p> <p>Do not connect to a circuit operating at more than 150 VAC to ground. For use on individual branch circuits only. Use only copper wires suitable for temperatures <math>\geq 90^{\circ}\text{C}</math>.</p>
<div style="background-color: #fff9c4; padding: 10px;"> <p><b>NOTICE:</b> Use only factory-supplied casters when needed. When this appliance includes casters, the following must also be installed:</p> <ul style="list-style-type: none"> <li>a connector complying with ANSI Z21.69 / CSA 6.16;</li> <li>a quick-disconnect device complying with ANSI Z21.41 / CSA 6.9;</li> <li>a restraining device to guard against transmission of strain to the connector as specified in the manual.</li> </ul> <p><b>AVISO:</b> Solo use ruedas proporcionadas de fábrica cuando sea necesario. Si este equipo incluye ruedas, también se debe instalar lo siguiente:</p> <ul style="list-style-type: none"> <li>un conector que cumpla con las normas ANSI Z21.69 y CSA 6.16;</li> <li>un dispositivo de desconexión rápida que cumpla con las normas ANSI Z21.41 y CSA 6.9;</li> <li>un dispositivo de sujeción para proteger contra la transmisión de tensión al conector como se especifica en el manual.</li> </ul> <p><b>AVIS :</b> S'il y a lieu, utiliser uniquement les roulettes fournies par le fabricant. Si cet appareil comporte des roulettes, les articles suivants doivent également être installés :</p> <ul style="list-style-type: none"> <li>un connecteur conforme à ANSI Z21.69 / CSA 6.16;</li> <li>un raccord découpleur rapide conforme à ANSI Z21.41 / CSA 6.9;</li> <li>un moyen de retenue pour empêcher la transmission de la contrainte au connecteur comme indiqué dans le manuel.</li> </ul> <p style="text-align: right; font-size: small;">LA-25784</p> </div>	<p>NOTICE: Use only factory-supplied casters when needed. When this appliance includes casters, the following must also be installed:</p> <ul style="list-style-type: none"> <li>a connector complying with ANSI Z21.69 / CSA 6.16;</li> <li>a quick-disconnect device complying with ANSI Z21.41 / CSA 6.9;</li> <li>a restraining device to guard against transmission of strain to the connector as specified in the manual.</li> </ul>

## How to Turn On the Oven

### Prerequisites

1. Turn on the exhaust hood.
2. Make sure that the water supply to the oven is turned on.
3. Make sure that the electrical power supply to the oven is turned on.
4. For gas ovens, make sure the gas supply valve is in the open position.

### Steps

1. Press the ON/OFF button

The ON/OFF indicator glows green and the loading screen a displays while the controller software loads. When the software is 100% loaded, the home screen b displays.

NOTE: If the oven has a steam generator, the steam generator fills with water and the oven heats the water to an initial temperature of 188°F (77°C).

## How to Start a Manual Calibration

1. Make sure the oven is off.
2. Press and hold the ON/OFF button for eight (8) seconds. The ON/OFF indicator glows red and the calibration prompt c displays.

The prompt moves from the center to all four corners of the screen. This sequence repeats three (3) times. Then the calibration screen d displays.

NOTE: The first time the oven is turned on, or if the oven loses power during startup, the touchscreen calibration prompt c displays at the end of the next startup.

NOTE: Touch the check mark icon to start the calibration immediately. Touch the cancel icon to cancel the calibration.

## How to Calibrate the Touchscreen

1. Touch the target icon (+) each time it appears on screen. The icon appears in all four corners, then the center of the screen.  
NOTE: If the controller software has not been updated to the current version (11/16 update), the calibration stops when this step is complete. Download the current controller software from the Alto-Shaam website and install it.
2. The verification screen e displays. Touch all five target icons . The icons change to green boxes when they are touched.

NOTE: The calibration screen and verification screen both display a 30-second countdown. If you do not touch all five icons before the countdown is complete, the controller stops the calibration. If you do not see the countdown, download the current controller software from the Alto-Shaam website and install it.

## How to Turn Off the Oven

1. Press and hold the ON/OFF button for five to ten (5-10) seconds.

## DANGER

Before starting the appliance, make certain you do not detect the odor of gas.

If you smell gas:

- Shut off the gas supply immediately.
- Do not attempt to light any appliance.
- Do not touch any electrical elements.
- Extinguish any open flame.
- Evacuate the area.
- Use a telephone outside the property and immediately contact your gas supplier.
- If unable to contact your gas supplier, contact the fire department.

---

## CAUTION

Accumulations on the main burners of gas appliances can result in firing out of normal sequence. This delayed ignition creates an alarmingly loud sound. If your appliance makes an especially loud noise when starting up, shut down the appliance and call a qualified and trained service technician.

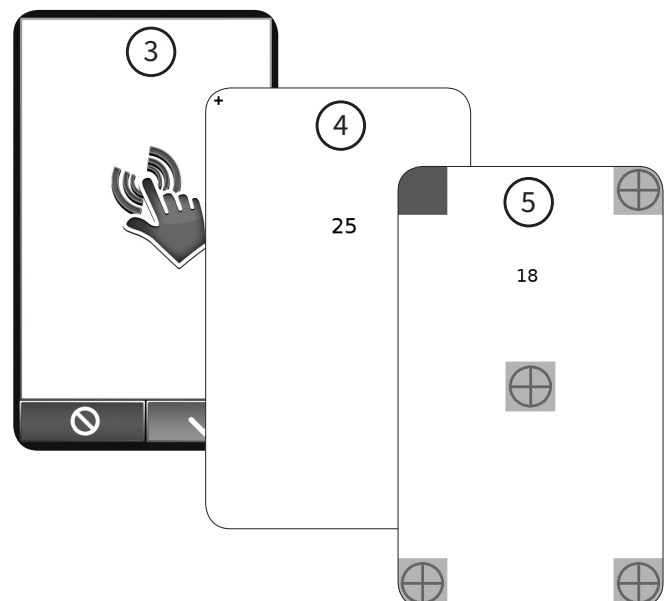



Control Panel Identification

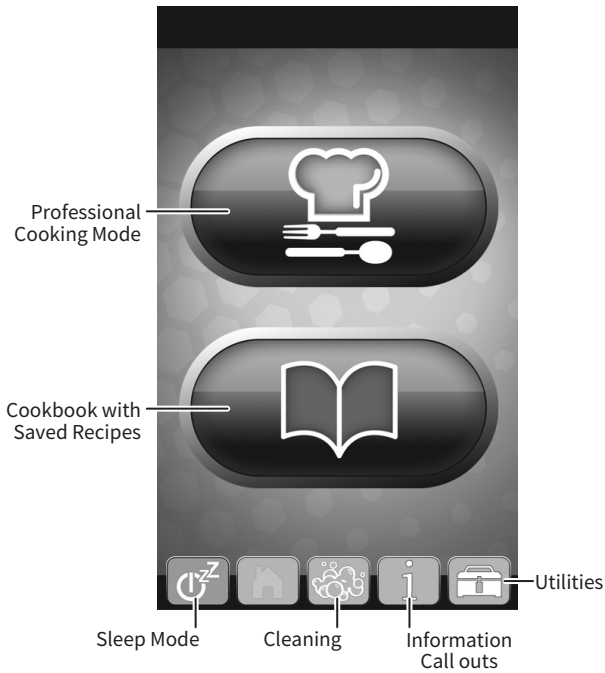

Utility Screen

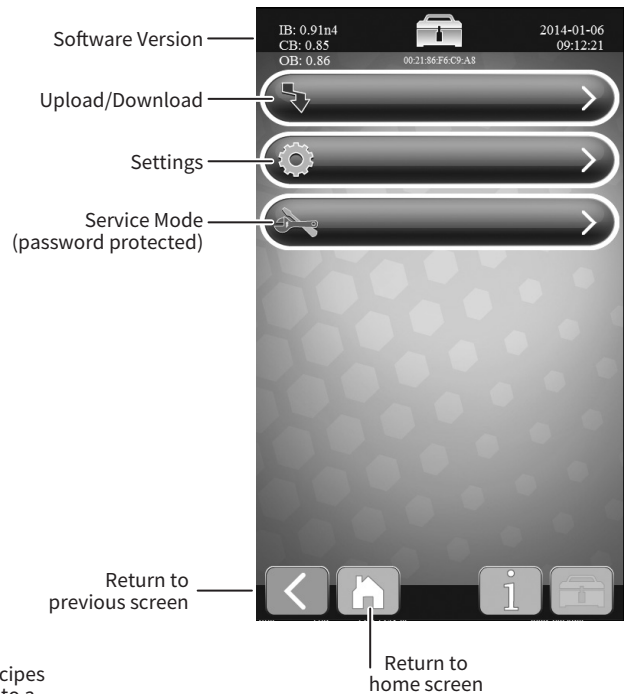

Upload/Download Screen

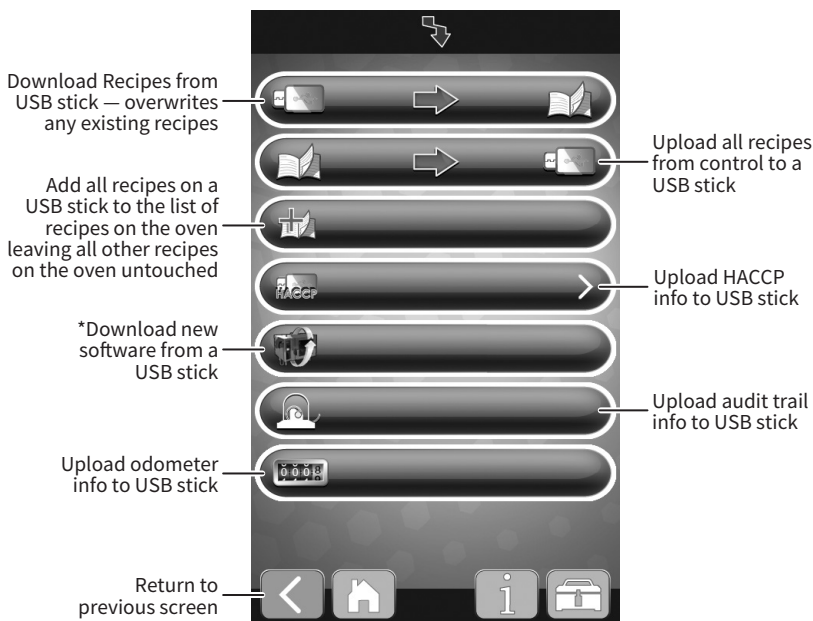

\*The PROtouch control plays an important part in our continuous improvement process. New features and abilities can be loaded to your oven as they become available. Software for your oven can be accessed from the Alto-Shaam website, under the Downloads tab.

**Control Panel Identification**

**Settings Screen 1**

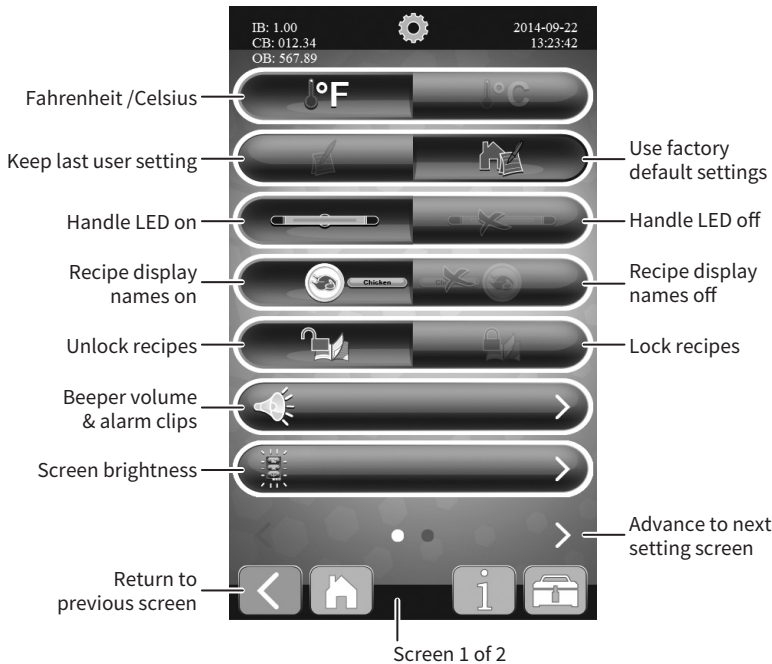

When a setting has been selected, the graphic will be vibrant in color while the alternate choice will appear faded and gray. In the illustration above, Fahrenheit, factory default setting, handle LED on, recipe display with text, and recipes are not locked have been chosen.

**NOTE:** A password is required to lock and unlock the recipes. Simply call an Alto-Shaam Culinary Chef for assistance.

**Settings Screen 2**

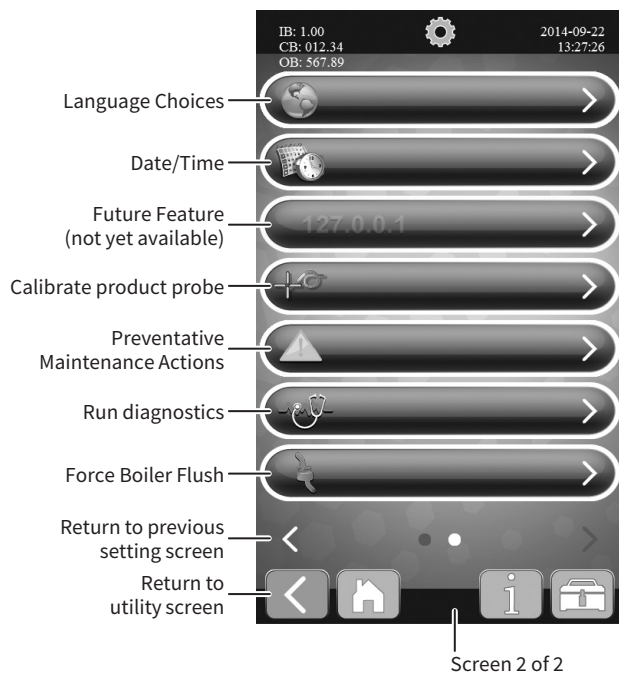

Language choices available:  
English, French, German, Korean, Mandarin, Russian, or Spanish.

Time format available:  
12-hour clock  
24-hour clock

Different date formats available:  
YYYY/MM/DD  
MM/DD/YYYY  
DD/MM/YYYY



**Control Panel Identification**

**Preventative Maintenance Screen**

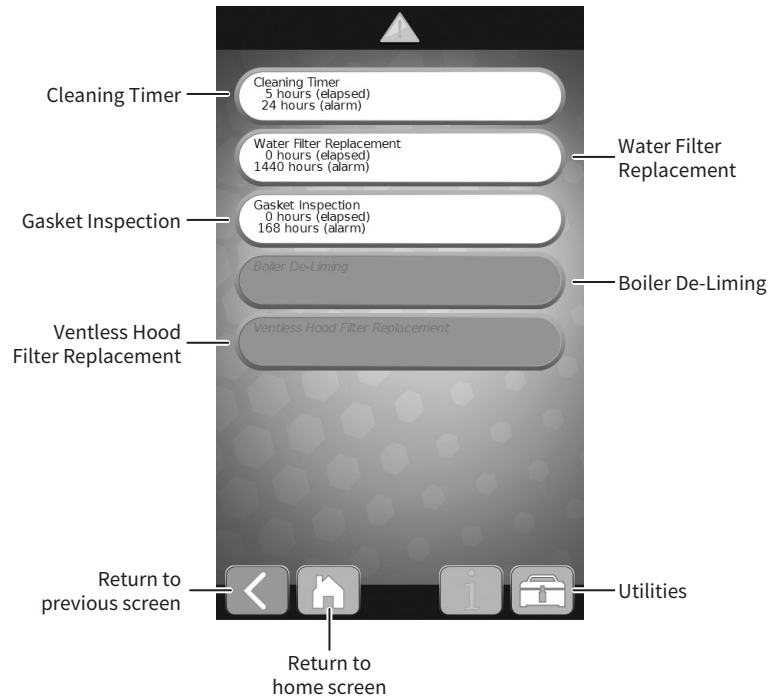



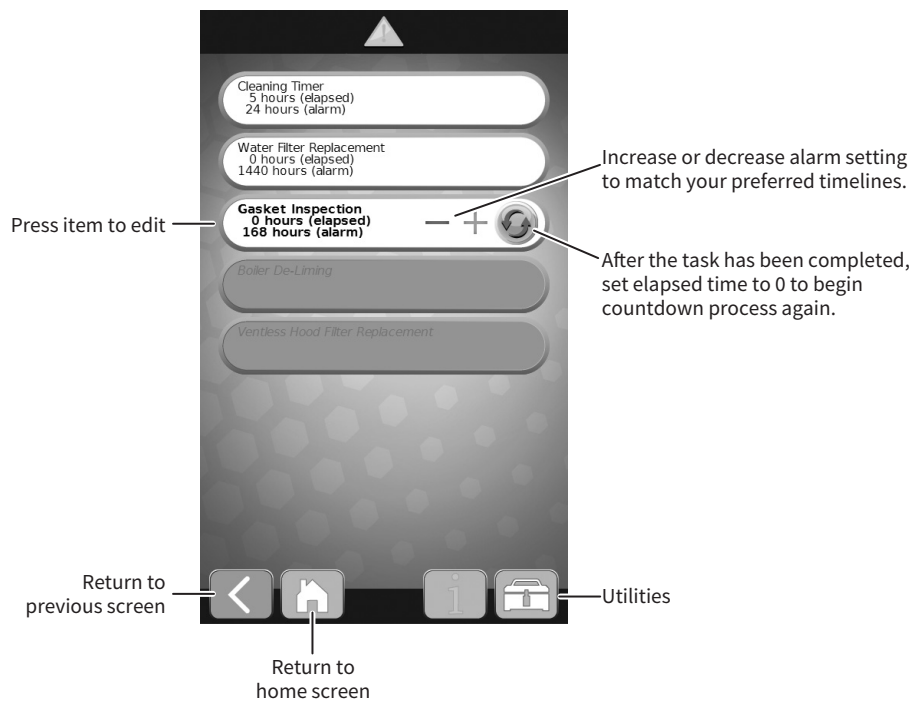

**Preventative Maintenance - Editing**



## Software Updates

The PROtouch controller plays an important part in our continuous improvement process. New features and abilities can be loaded to your oven as they become available. Software for your oven can be accessed from the Alto-Shaam website, under the Resource Library Tab, then Software Center. <http://www.alto-shaam.com/en/software-download-center>

Use a USB stick to copy the PROtouch software from the website to the USB stick.

-  Press the ON button to power the oven on.
-  Touch the utilities icon.
-  Touch the download icon.
-  Touch the download new software icon.

Most software updates will require the full oven update as shown below. Additional options are available in the event a special need arises. Call our Service Department for assistance with these special circumstances.

Remove the cover of the USB port on the oven.

Insert the USB stick. If the USB stick is not recognized by the Combitherm, a question mark will appear on screen. Try again with another flash drive device or call Alto-Shaam Service.

When the data has made a successful transfer to the USB drive, the screen will change.

Touch the green check mark icon to complete the process.

Remove the USB stick and replace the cover on the USB port on the oven.

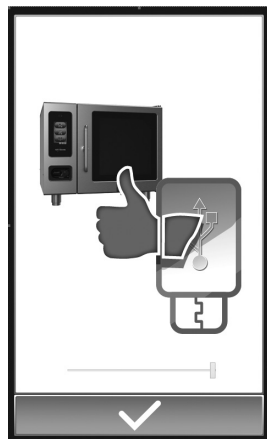

**NOTICE:** After the software update has been completed, the oven may automatically initiate a shut down and reboot sequence if required.

## Software Upload Screen



Cooking Screen Identification

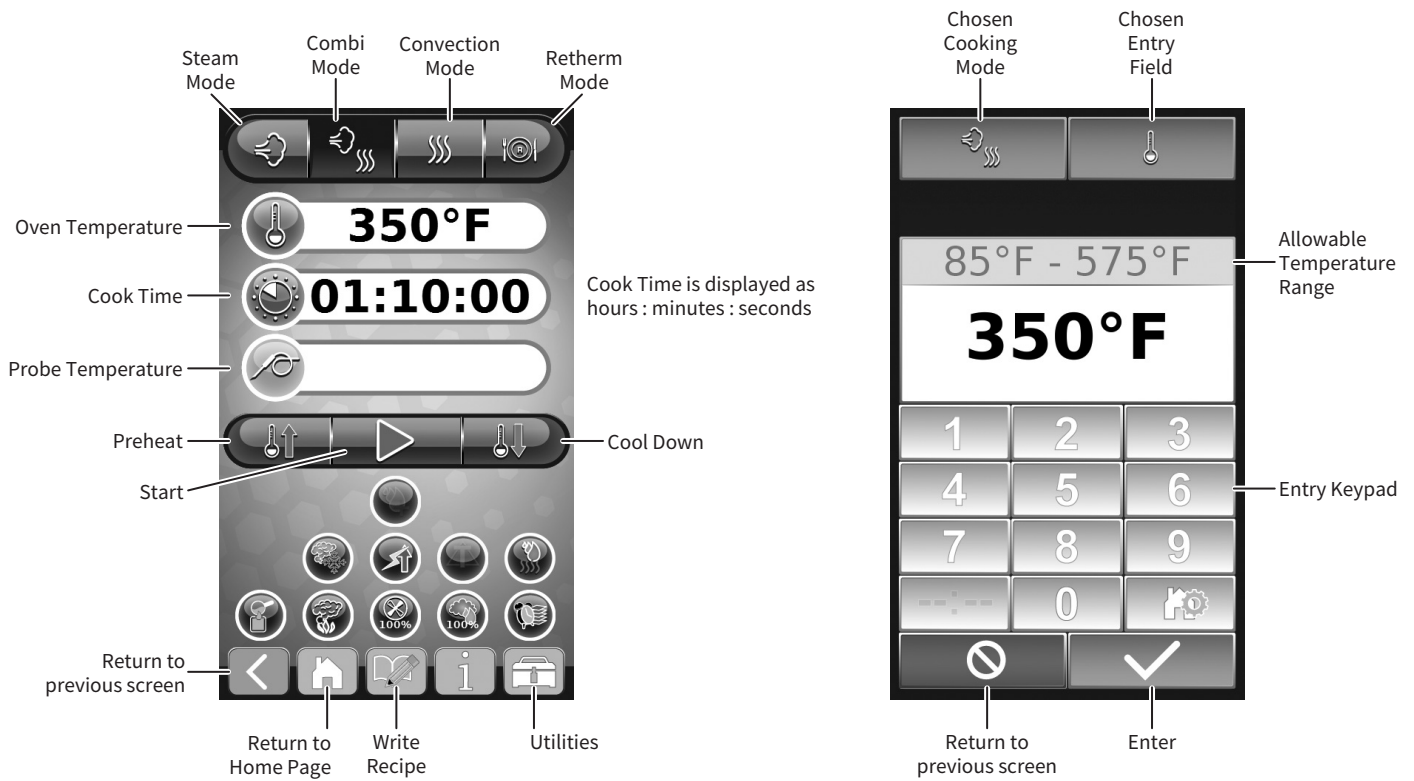

**NOTE:** When a cooking mode has been selected, it will appear darker blue. When the cooking mode is calling for heat, it will appear red. When the cooking mode is calling for moisture, it will appear light blue. In the illustration above, Combi Mode has been chosen and is calling for heat. Also, the PROpower™ level has been chosen, and the fan speed has been set at 100%.

## Auxiliary Functions and Features

### Power Settings

**Two power levels:** reduced power to manage kitchen power peaks, and eco power for optimal oven efficiency.

A third choice is optional on electric models, but standard on gas models. PROpower™ is an accelerated turbo power for an instant boost of heat or quick heat recovery [patent pending].

**NOTE:** Reduced power will result in longer cooking times and PROpower will decrease your cooking time by several minutes.

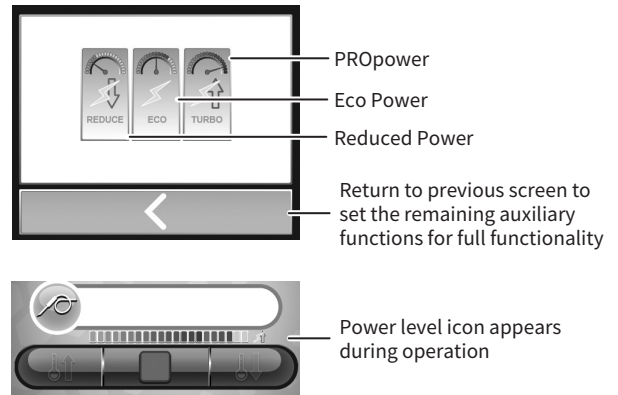

### Multiple Fan Speeds

The PROtouch™ control includes five different fan speeds. The reduced fan speed function is useful for flow-sensitive products such as soufflés and meringues, or any products affected by a high velocity of air movement.

**NOTE:** Fan speed choices are based upon the power level you have chosen.

### Fan speed choices

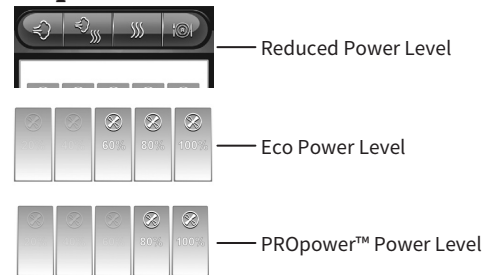

### Multi-Shelf Timer

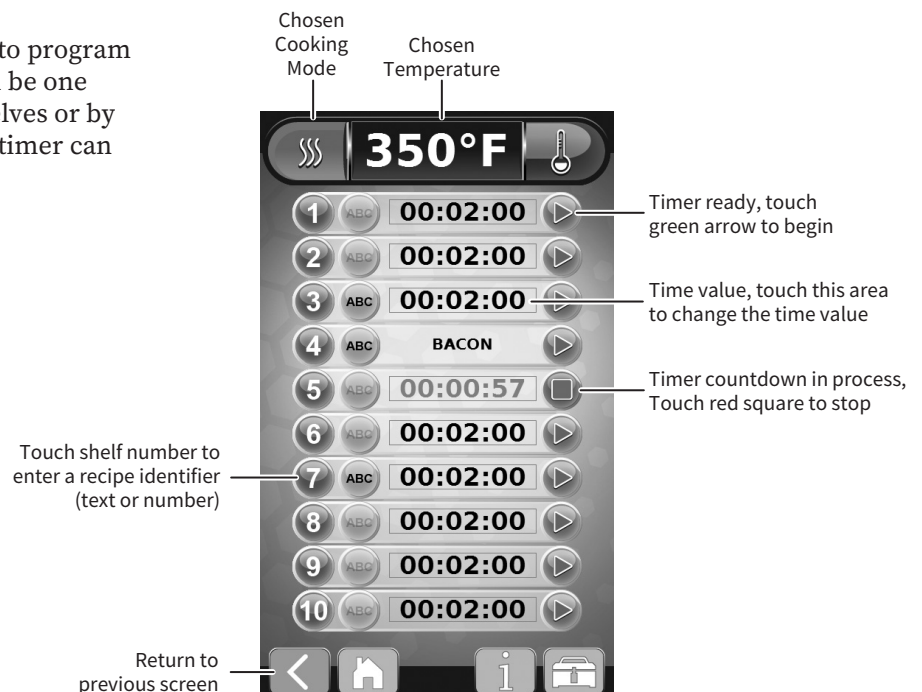

The multi-shelf timer allows the operator to program alarm times for the oven shelves. This can be one common time for corresponding oven shelves or by food item that is cooking. The multi-shelf timer can be edited when in a recipe mode.



## Auxiliary Functions and Features

### Preheat Feature

The oven should be preheated before most cooking functions. When cooking full loads, use a temperature 50°F (10°C) greater than the cook temperature in order to recover from heat loss when the door is opened to add food to the oven. For items that use the Steam mode, it is necessary to use a preheat temperature lower than the cook temperature in order to create the proper amount of steam.

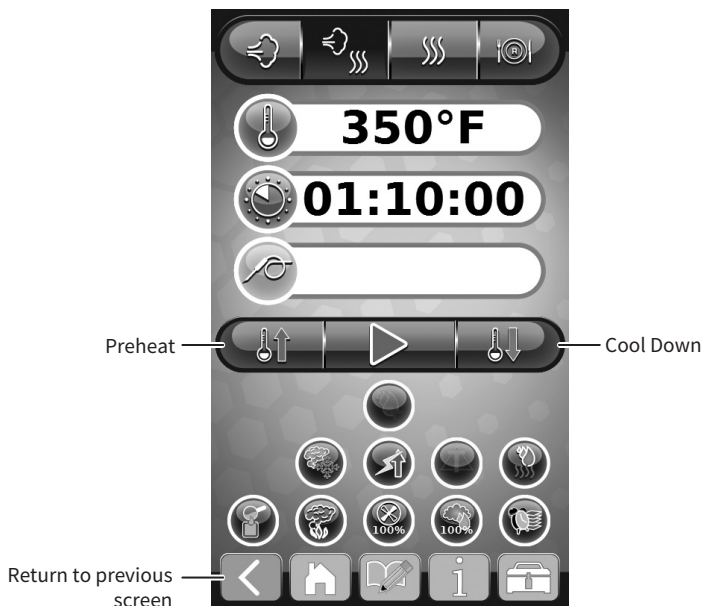

-  Press the On button to power oven on.
-  Touch the Preheat icon.  
Type in desired temperature.
-  Touch the green Check Mark icon to start preheating.



### Cool Down Feature

The cool-down feature provides the operator with the ability to lower the temperature of the oven compartment at an accelerated pace. This function is useful when it is necessary to immediately change from a high temperature cooking function to a lower temperature function or to the steam program. This function is also useful to help cool the oven compartment in preparation for cleaning.

**TIP:** Always allow the oven walls to cool to a minimum of 140°F (60°C) before spraying the compartment with oven cleaner.

- Open the oven door.
-  Touch the Cool Down icon.  
Type in desired temperature.
-  Touch the green Check Mark icon to begin the Cool Down process.

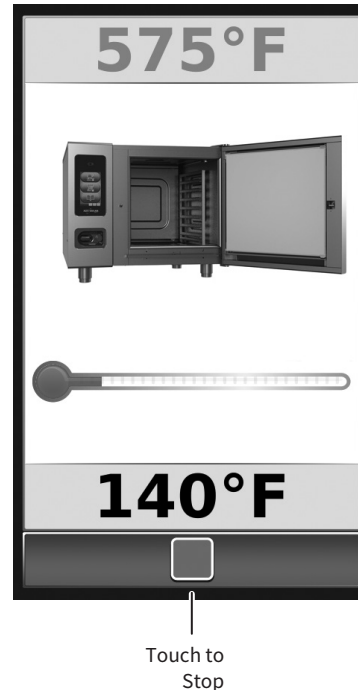

The target oven temperature chosen will appear just above the red Stop button.

The current oven temperature will appear at the top of the screen.

**Auxiliary Functions and Features**

**Humidity Control Feature**

The humidity control feature is an automatic function designed to regulate humidity to provide additional color to food as needed. This feature is particularly useful for adding color to high moisture products such as chicken and other poultry, or for additional browning of full loads and other moist products. In addition, this feature may be used to add texture to fried items such as french fries or breaded chicken. Humidity control can be used in any cooking mode and can be programmed into a cooking procedure.

Touch the nearest 10% increment on the left side of the screen, and then adjust up or down using the + or - icons.

0% humidity is the driest cooking environment available. The percentage level chosen will appear on the icon. In the illustration at right, 72% is shown.

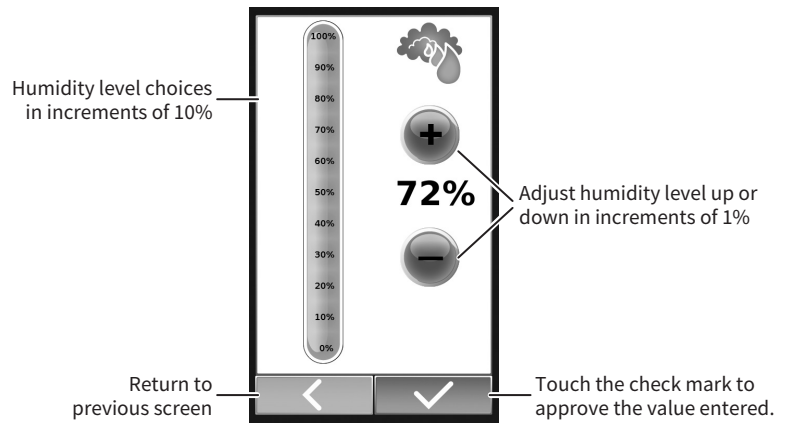

**Rapid Cool** (available on boiler-free models only)

This function, when used with a program, rapidly removes heat from the oven cavity. Swiftly move from a high cooking temperature to a lower temperature without overcooking your food.

**Rest**

This step allows you to pause the oven during a program. The rest step is ideal for cold smoking or automatic cleaning. Infuse your food with smoke flavor after the actual smoking step has stopped.



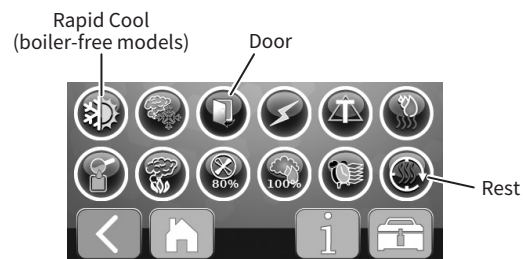

**Door**

The door function allows the user to program a reminder—in the form of an animated door opening and closing—that it is time to open the door. This reminder may be programmed at the end of a programmed segment or at the end of the program.







## CT PROformance™ Factory Default Settings

Cooking Mode	Oven Temperature	Core Temperature	Cooking Time
Steam 	212°F (100°C)	160°F (70°C)	25 minutes
Combination Steam 	350°F (175°C)	160°F (70°C)	70 minutes
Convection 	350°F (175°C)	160°F (70°C)	30 minutes
Retherm 	275°F (135°C)	160°F (70°C)	5 minutes

## Steam Mode

The Steam mode provides the operator with the ability to steam, poach, or blanch. This mode will automatically steam at the boiling point of water; quick-steam above the boiling point for faster cooking results; or low temperature steam, below the boiling point, for more delicate products such as pâté, mousse, seafood, or custard.

 Press the On button to power oven on.

 Touch the Professional Cooking mode icon.

 Touch the Steam mode icon.

 Touch the Start icon to steam at the displayed settings.

### To Change the Displayed Settings:

 Touch the area to the right of the temperature icon.  
Type in desired temperature.

 Touch the green Check Mark icon to confirm change.

- Automatic Steaming 212°F (100°C)
- Quick Steaming 213°F to 250°F (101°C to 120°C)
- Low Temperature Steaming 85°F to 211°F (30°C to 99°C)

### To Cook by Time:

 Touch the area to the right of the time icon.  
Type in desired time or set continuous time by touching --:--.

 Touch the green Check Mark icon to confirm change.

### To Cook by Product Core Temperature:

 Touch the area to the right of the probe icon.  
Type in desired temperature.

 Touch the green Check Mark icon to confirm change.

Insert probe into product.

Set available auxiliary functions as desired, such as energy level, fan speed, multi-shelf timer, etc.

 Touch the Start icon to begin cooking in the Steam mode.

- The cavity set-temperature will appear in the display.
- If cooking by probe, the actual internal product temperature will appear next to the probe icon during operation. To change the set value for core temperature, touch the temperature next to the probe icon and make changes as required.

When the cooking time has expired or the desired core temperature has been reached, an alarm will sound and handle light will flash several times indicating the end of the operating mode.

 Touch the red Stop icon to stop the buzzer or open the oven door.

 To stop cooking program at any time, touch the red Stop icon.

## CAUTION HOT

Use caution when opening the oven door when the cooking chamber is hot to avoid possible burns.

## Steam Mode Chef Operating Tips



This mode will steam a full or partial load of a single product, or multiple products without transfer of flavors. When steaming multiple products, however, individual product cooking times must be taken into consideration.

The non-pressurized atmosphere of the Combitherm also provides the ability to open the door during the steam mode in order to monitor products more closely throughout the steaming process.

### Steam

Perforated, 2-1/2" (65mm) deep pans are particularly suitable for use in this program mode. These pans will provide a shorter cooking time and will prevent product over-cooking at the bottom of the pan.

Separate ice-encrusted vegetables before steaming to ensure even cooking.

A variety of products can be steamed at the same time but attention must be paid to the different cooking times required for each food product.

When cooking by probe, the probe must be inserted so that the tip is positioned in the center of the food mass. For liquid or semi-liquid foods, suspend the probe in the center of the product and secure the probe wire to the edge of the container.

### High Temp Steam

High temperature steaming is suitable for hearty, root-type vegetables such as potatoes, turnips, carrots, and cabbage.

High temperature steaming provides a cooking time which is approximately 10% shorter than the regular steam mode temperature of 212°F (100°C).

### Low Temp Steam

The low temperature steam mode will function whenever the oven compartment temperature is below 212°F (100°C).

It will take longer to steam products using the low temperature steam mode.

Steaming sausages in low temperature steam prevents cracked or peeling skins.

Use low temperature steam for delicate foods such as shrimp, fish, seafood, crème caramel, and sous vide.

For best results, low temperature steam all delicate food items at a temperature of 210°F (99°C) or below.

## Combination Mode



The Combination mode will prove to be the most versatile and widely used mode the Combitherm oven has to offer. It will produce the best possible results on the widest variety of products — all within the shortest period of time. The unique control function of this mode enables the operator to roast or bake with a combination of steam and convection heat. In addition to shorter cooking times, this combination of steam and heat offers less product shrinkage and more moisture retention than obtained in a convection oven.



Press On button to power oven on.



Touch the Professional Cooking mode icon.



Touch the Combination mode icon.



Touch the Start icon to cook at the displayed settings.

### To Change the Displayed Settings:



Touch the area to the right of the Temperature icon.

Type in desired temperature.



Touch the green Check Mark icon to confirm change.

- Cooking temperature range:  
85°F to 575°F (30°C to 301°C)

### To Cook by Time:



Touch the area to the right of the time icon.

Type in desired time or set continuous time by touching --:--.



Touch the green Check Mark icon to confirm change.

### To Cook by Product Core Temperature:



Touch the area to the right of the Probe icon.

Type in desired temperature.



Touch the green Check Mark icon to confirm change.

Insert probe into product.

Set available auxiliary functions as desired, such as energy level, fan speed, multi-shelf timer, steam injection, etc.



Touch the Start icon to begin cooking in the Steam mode.

- The cavity set-temperature will appear in the display.
- If cooking by probe, the actual internal product temperature will appear next to the PROBE icon during operation. To change the set value for core temperature, touch the temperature next to the PROBE icon and make changes as required.

When the cooking time has expired or the desired core temperature has been reached, an alarm will sound and handle light will flash several times indicating the end of the operating mode.



Touch the red Stop icon to stop the buzzer or open the oven door.



To stop cooking program at any time, touch the red Stop icon.

## CAUTION HOT

Use caution when opening the oven door when the cooking chamber is hot to avoid possible burns.

## Combination Mode Chef Operating Tips



The Combination mode injects the optimum amount of steam automatically. There is no need to select humidity levels. Foods do not dry out. Flavors are retained with no transfer of flavors when mixing product loads.

Due to automatic steam adjustment, the door can be opened at any time during a cooking operation. Be certain to observe the safety warning when opening the oven door.

The Combination mode is particularly efficient when used for baking, broiling, grilling, stewing, braising, and roasting.

When using the Combination mode, cooking temperatures can be reduced 10%–20% below the temperatures used for conventional cooking methods.

Cooking time will be reduced approximately 40% when cooking at the same temperature used for convection oven cooking and up to 50%–60% less time when cooking at the same temperature used for a conventional oven.

Food browning in the Combitherm begins at a cooking temperature of approximately 250°F (120°C).

A higher cooking temperature results in heavier browning but also results in greater product weight loss. To achieve additional browning set humidity control into the product procedure. Humidity control is particularly useful for adding color to high moisture products such as chicken and other poultry items or for additional browning of full loads and other moist products.

The Combination mode provides even browning without the necessity to turn the pans.

For more even cooking, do not cook in pans deeper than 4" (100mm).

When cooking by probe, the probe must be inserted so that the tip is positioned in the center of the food mass. For liquid or semi-liquid foods, suspend the probe in the center of the product and secure the probe wire to the edge of the container.

## Convection Mode

The Convection mode operates with hot circulated air within a temperature range of 85°F to 575°F (30°C to 300°C). For many applications, better results may be achieved with the Combination mode; therefore, the operator may want to consider using the Convection mode on a more limited basis. The use of high temperatures (500°F to 575°F) are not intended for continuous use.

 Press On button to power oven on.

 Touch the Professional Cooking mode icon.

 Touch the Convection mode icon.

 Touch the Start icon to cook at the displayed settings.

### To Change the Displayed Settings:

 Touch the area to the right of the temperature icon.  
Type in desired temperature.

 Touch the green Check Mark icon to confirm change.

- Cooking temperature range: 85°F to 575°F (30°C to 300°C)

### To Cook by Time:

 Touch the area to the right of the Time icon.  
Type in desired time or use up and down arrows to adjust temperature or set continuous time by Touching --:--.

 Touch the green check mark key to confirm change.

### To Cook by Product Core Temperature:

 Touch the area to the right of the Probe icon.  
Type in desired temperature.

 Touch the green check mark key to confirm change.  
Insert probe into product.

Set available auxiliary functions as desired, such as energy level, fan speed, multi-shelf timer, steam injection, etc.

 Touch the Start icon to begin cooking in the Steam mode.

- The cavity set-temperature will appear in the display.
- If cooking by probe, the actual internal product temperature will appear next to the probe icon during operation. To change the set value for core temperature, touch the temperature next to the probe icon and make changes as required.

 Touch steam Injection at any time during cooking. Steam will inject into the cavity as long as the icon is touched.

When the cooking time has expired or the desired core temperature has been reached, an alarm will sound and handle light will flash several times indicating the end of the operating mode.

 Touch the red Stop icon to stop the buzzer or open the oven door.

 To stop cooking program at any time, touch the red Stop icon.

## CAUTION HOT

Use caution when opening the oven door when the cooking chamber is hot to avoid possible burns.

## Convection Mode Chef Operating Tips



The Convection Mode can be used to roast or bake products needing very short cooking times or for high moisture products such as muffins, cakes, and cookies, or for browning the surface of the food.

The Convection mode works best with low moisture foods or for very moist food which require a dryer finished product.

For baking, preheat the Combitherm at a temperature of 325°F to 375°F (163°C to 191°C). Once preheated, reset the temperature as required.

A higher cooking temperature results in heavier browning but also results in greater product weight loss. To achieve additional browning set the Humidity control into the product procedure.

When cooking by probe, the probe must be inserted so that the tip is positioned in the center of the food mass. For liquid or semi-liquid foods, suspend the probe in the center of the product and secure the probe wire to the edge of the container.

## Retherm Mode

The Retherm mode operates with hot circulated air within a temperature range of 245°F to 320°F (120°C to 160°C).

 Press On button to power oven on.

 Touch the Professional Cooking mode icon.

 Touch the Retherm mode icon.

 Touch the Start icon to retherm at the displayed settings.

### To Change the Displayed Settings:

 Touch the area to the right of the Temperature icon.

Type in desired temperature.

 Touch the green Check Mark icon to confirm change.

- Cooking or retherming temperature range: 245°F to 320°F (120°C to 160°C)

### To Cook by Time:

 Touch the area to the right of the Time icon.

Type in desired time or set continuous time by touching --:--.

 Touch the green Check Mark icon to confirm change.

### To Cook by Product Core Temperature:

 Touch the area to the right of the Probe icon.  
Type in desired temperature.

 Touch the green Check Mark icon to confirm change.

Insert probe into product.

Set available auxiliary functions as desired, such as energy level, fan speed, multi-shelf timer, steam injection, etc.

 Touch the Start icon to begin cooking in Steam mode.

- The cavity set-temperature will appear in the display.
- If cooking or retherming by probe, the actual internal product temperature will appear next to the PROBE icon during operation. To change the set value for core temperature, touch the temperature next to the PROBE icon and make changes as required.

 Touch Steam Injection at any time during cooking. Steam will inject into the cavity as long as the icon is touched.

When the cooking time has expired or the desired core temperature has been reached, an alarm will sound and handle light will flash several times indicating the end of the operating mode.

 Touch the red Stop icon to stop the buzzer or open the oven door.

 To stop cooking program at any time, touch the red Stop icon.

## CAUTION HOT

Use caution when opening the oven door when the cooking chamber is hot to avoid possible burns.



## Retherm Mode Chef Operating Tips



Since plated meals consist of dissimilar products, there are several important factors to consider in order to produce the finest results. Product density (compactness), thickness, quantity of product on each plate, and quantity of plates all relate to the length of time necessary to reheat. Again, experience is the best method to determine reheating time. Once the time has been determined and recorded for a specific meal, the results will be consistent for future reheating times.

### Helpful Hints For Reheating On The Plate

- All food components on the plate should be of similar densities and thickness.
- Arrange all food components evenly on the plate.
- Avoid excessive overlapping of product.
- Sauces must be heated and added to product after reheating.
- A mixed variety of meals can be reheated at the same time.

### À La Carte Rethermalization

À la carte rethermalization is designed to take a single plate from a refrigerated temperature to serving temperature for immediate service. Plates are prepared in advance, covered, and refrigerated. Preheat the Combitherm oven. Remove plate from refrigeration and place in the oven at 275°F (135°C) for an uncovered plate or 300°F (150°C) for a covered plate. Plates with meat components will take more time than plates containing all vegetable components. Follow internal temperature requirements for reheating and allow for override time. After reheating, remove the plate from the oven, add any sauces, garnish, and serve. This process can be repeated as required.

For the most efficient continuous service, it is suggested that the Combitherm oven be dedicated to the rethermalization process during serving hours.

### Banquet Rethermalization

Banquet rethermalization is designed for high volume, full or partial load (multiple plate) reheating.

Plates are assembled in advance, covered, and refrigerated or loaded on the roll-in cart and refrigerated. Preheat the Combitherm oven at 275°F (135°C) for uncovered plates or 300°F (150°C) for covered plates. Remove plates or the roll-in cart from refrigeration, load in the oven and set timer as required. Follow internal temperature requirements for reheating and allow for override time. Remove the plates or roll-in cart from the Combitherm.

Placing our thermal blanket cover over the roll-in cart keeps food hot for 20 to 40 minutes, depending on the type of food, retherm temperature, and environmental factors. For longer holding times, roll the cart into the CombiMate® companion holding cabinet.

### Rethermalizing Prefabricated and Vacuum-Packed Frozen Foods

For bulk product rethermalization, completely defrost product bags in walk-in cooler. **DO NOT REMOVE PRODUCT FROM THE BAG.** Load thawed bags in preheated oven and rethermalize in the Low Temperature Steam mode until the required internal temperature is reached. Place rethermalized bags in a preheated holding cabinet set at 140° to 165°F (60° to 74°C) until ready for service.

For large volume on-the-plate regeneration, defrost bags in walk-in cooler. Open bags and plate per menu requirements in a (maximum) 55°F (13°C) refrigerated room. Place on Alto-Shaam roll-in cart (trolley), and roll into Combitherm oven preheated at 275°F (135°C).

Regenerate in the Convection mode for 3 to 5 minutes. Switch to the Retherm mode for an additional 3 minutes or more if required. Placing our thermal blanket cover over the roll-in cart keeps food hot for 20 to 40 minutes, depending on the type of food, retherm temperature, and environmental factors. For longer holding times, roll the cart into the CombiMate® companion holding cabinet.

Plate covers must be used for on-the-plate regeneration.

## Dehydration Mode

Dehydration is a long, slow process that takes place at low heat and zero humidity. It changes the physical properties of food items and intensifies flavors. Dehydrated items can be combined and presented in new and unexpected ways, from pliable leathers to crispy chips to powders. Dehydration is also an effective way to preserve food items for long-term storage with minimal impact on flavor.

### How To Cook Using Dehydration Mode

1. Touch the dehydrate icon e. The controller does the following:
  - Sets the cooking mode a to convection.
  - Sets the power mode f to ECO.
  - Sets the cooking temperature b to 140°F (60°C).
  - Sets the cooking time c to continuous (--:--).
  - Sets the fan speed h to 60%.
  - Sets the humidity level i to 0%.
  - Turns off the smoker g and Delta-T j functions, if they have been selected.

NOTE: These functions should remain off during dehydration

2. To change the cooking temperature, touch the displayed temperature b. The touchpad screen displays.
3. Use the number keys k to enter the cooking temperature, then touch the check mark icon l.
4. To set a cooking time, instead of having the dehydration run continuously, touch the displayed time ③. The touchpad screen displays.
5. Use the number keys k to enter the cooking time (hh:mm:ss), then touch the check mark icon l.

NOTICE: Changing any of the default settings other than temperature and time is not recommended.

6. Load food into the oven.
7. Touch the start icon d. The start icon changes to a red square (stop icon) and the oven begins cooking.

NOTE: If the cooking time is continuous, cooking continues until the stop icon is touched. If the cooking time is set, the controller sounds an alarm and cooking stops when the cooking time has elapsed.

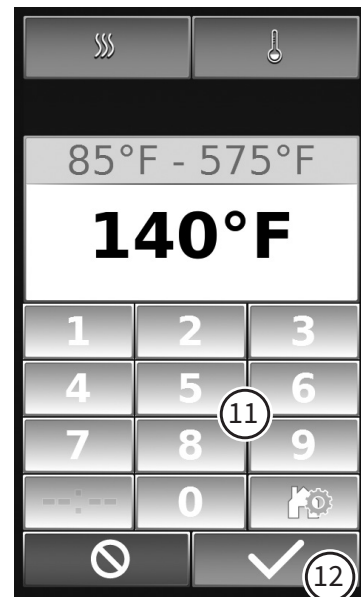
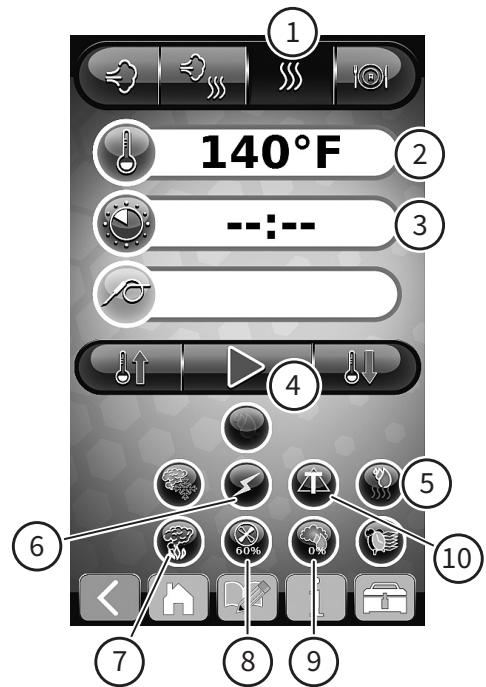

## Dehydration Mode Chef Operating Tips



- Place a silpat or other silicon liner on each cooking tray. Do not use liners made of parchment or paper.
- All food items should be well spaced and placed flat on the cooking tray.
- Allow dehydrated food items to cool fully before removing them from the cooking tray.
- Many food items benefit from processing before dehydration. Examples include:
  - Puree vegetables, then dehydrate in an even, thin layer to create papers and powders.
  - Cut fruit into thin slices and dip in a simple syrup prior to dehydration.
  - Mix pureed items prior to dehydration to create new flavor profiles.
  - Pre-cook vegetables such as carrots before pureeing and dehydrating.

## Delta-T Core Temperature Cooking Mode

This special program function cooks by internal product temperature with the use of the probe. The Delta-T cooking program increases the oven temperature in direct proportion to the internal temperature of the product, in contrast to the traditionally constant oven temperature. For example, the oven temperature will always be 100°F higher than the product itself. This slow cooking allows more time for enzymes to tenderize the meat. The Delta-T mode can be used with both convection and combination modes, providing a more gentle method of cooking. Browning occurs toward the end of the cooking cycle.



Press On button to power oven on.



Touch the professional cooking mode.



Available in convection mode or combination mode, touch the desired Cooking Mode icon.



Touch the area to the right of the probe icon.

Type in desired final internal product temperature.



Touch the green check mark key to confirm change.

Insert probe into product.



Touch auxiliary function Delta-T icon.

Type in desired Delta-T temperature.



Touch the Start icon to begin cooking.

- The actual internal product temperature will appear next to the probe icon during operation. To change the set value for core temperature, touch the temperature next to the probe icon and make changes as required.



Touch steam Injection at Any Time During Cooking. Steam will inject into the cavity as long as the icon is touched.

When the operator-set internal temperature has been reached, an alarm will sound and handle light will flash several times indicating the end of the operating mode.



Touch the red Stop icon to stop the buzzer or open the oven door.



To stop cooking program at any time, touch the red stop icon

CAUTION HOT

Use caution when opening the oven door when the cooking chamber is hot to avoid possible burns.

**Calibrate the Touch Oven Probe**

Fill a pitcher with blended ice and water and place inside the combi oven.

Snap probe in place at top of oven and insert probe into the pitcher of blended ice water.

With the CT PROformance oven “ON”, touch the “Utilities” icon on the home page.

Touch the “Settings” icon.

Touch the “>” icon to advance to page 2 of the Settings screen.

Touch the “probe” icon on the Settings screen.

Once the temperature reading has stabilized, adjust setting to 32°F (0°C) using the + or - icons. Touch the “Home” icon to return to the home screen.

The control has now been calibrated to use the probe at appropriate temperatures.

CombiSmoker® Procedures

Loading Wood Chips

1. To determine the amount of chips to use, fill the smoker box with dry wood chips. The lid must be able to close.
2. Remove the wood chips from the smoker box and place them in a container of clean water. Be sure the wood chips are fully immersed and soak the wood chips for 15 minutes.
3. Shake the excess water off the wood chips and place them back into the smoker box.
4. Position the container securely on the two prongs located on the interior side panel of the oven.

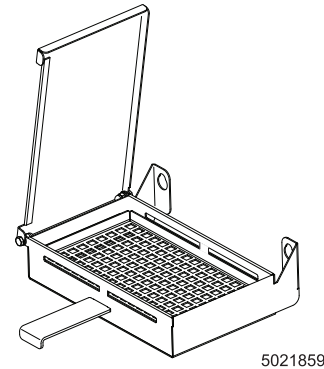

A full smoker box will produce smoke for approximately one to two hours depending on the cooking temperature.

**! WARNING**

DO NOT open the oven door during the smoking function. The introduction of outside air into the oven compartment may cause the wood chips to flame.

**! WARNING**

**Fire Hazard**

The use of improper materials for the smoke function could result in a fire which may lead to personal injury or property damage.

Only use wood chips supplied by Alto-Shaam.

Soak the wood chips in water for 15 minutes before using.

**! WARNING**

When smoking is completed, remove smoker box from oven. Dispose of wood chips in a fire proof receptacle to prevent the risk of fire.

Available From Alto-Shaam		
Wood Chips	2.5 cu.ft. (71 L) / 50 lbs. (108 kg)	
The total weight of wood chip bulk packs may vary due to high moisture content when packaged.	Cherry	WC-37746
	Apple	WC-37747
	Sugar Maple	WC-37748
	Hickory	WC-37749

Chef Operating Tip

Products such as ribs that require heavier smoke penetration to reach full smoke flavor should remain in the oven after cooking has been completed. Do not open the oven door.

Set the oven in the Low Temperature Steam Mode at 140° to 160°F (60° to 71°C) and allow the product to remain in the oven for a period of one hour.

If you would like assistance, you are invited to contact an Alto-Shaam corporate chef for recommendations.

The CT PROformance CombiSmoker can be operated without using the smoking function. After using the oven as a smoker, however, it is necessary to clean the oven in order to prevent a transfer of smoke flavor to non-smoked products. Cleaning instructions are provided in this manual.

## CombiSmoker® Procedures

The ability to smoke product, hot or cold, is offered on all CTP models. The smoking function can be engaged in either the Combination mode or the Convection mode of operation. The smoking function cannot be operated when the oven is operating in the steam mode or the retherm mode.

 Press on button to power oven on.

 Touch the professional cooking mode.

 Touch the desired cooking MODE icon, convection or combination.

### To Change the Displayed Settings:

 Touch the area to the right of the temperature icon.  
Type in desired temperature.

 Touch the green check mark key to confirm change.

### To Cook by Time:

 Touch the area to the right of the time icon.  
Type in desired time.

 Touch the green check mark key to confirm change.

### To Activate CombiSmoke:

 Touch auxiliary function smoking icon.

 Touch the Start icon to begin smoking.

**CAUTION**



To prevent **personal injury** or **property damage**:

**Always** use hand protection when operating this appliance to avoid burns. Metal parts of this equipment become extremely hot when in operation.

## Cold Smoking Procedures

 Touch convection cooking MODE icon.

### To Change The Displayed Settings:

 Touch the cold smoking icon.  
The temperature will display -----°.

### To Cook by Time:

 Touch the area to the right of the time icon.  
Type in desired time.

 Touch the green check mark key to confirm change.

Place a pan of ice on a shelf immediately below the product.







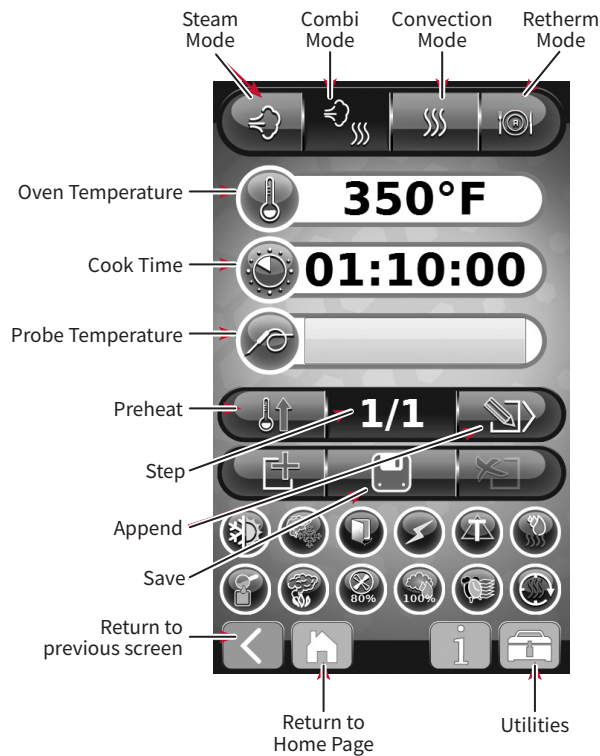

 Touch THE START icon TO begin smoking.

**CAUTION HOT**

Use caution when opening the oven door when the cooking chamber is hot to avoid possible burns.

## Recipe Programming



1. While on the cooking mode screen, touch the Write a Recipe icon. 
2. Enter the desired cooking mode, cooking temperature, and cooking time.
3. Add any desired special functions. For example:
  - If the recipe requires a reminder to open the door at the end of the segment, touch the Door icon. 
  - If the recipe requires a rest period, touch the Rest icon. 
  - If the recipe requires rapid removal of heat, touch the Rapid Cool icon. 
4. If the recipe is complete, go to step 6. If the recipe calls for additional segments, touch the Append icon. 
5. Enter the desired cooking mode, cooking temperature, and cooking time. If required, add a special function—see step 3. Then, touch the Append icon. Repeat for each additional cooking segment. 
6. Touch the Save icon when all segments have been written. A touch pad will appear. 
7. Choose a photo or input the name of the recipe, then touch the Check Mark icon. 

NOTE: Each recipe can have up to 10 segments.

## Using Programmed Recipes

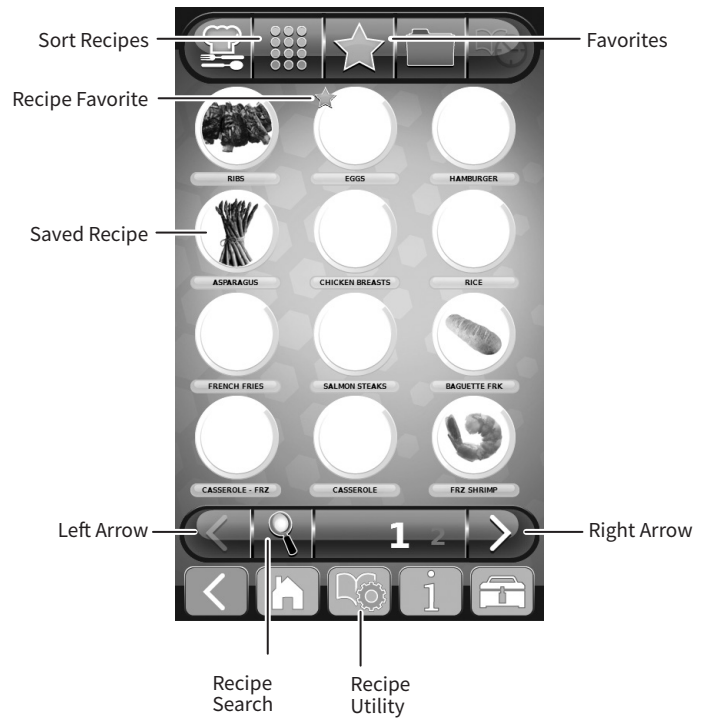

### To Cook with Preprogrammed Recipes

- Touch the cookbook with saved recipes icon in the home screen. The recipe screen displays.
- Locate the recipe by doing one of the following:
  - Touch the favorites icon to display favorite recipes.
  - Touch the sort recipes icon to sort recipes, then select frequency, alphabetic order, or last modified date as the sort criteria.
  - Touch the recipe search icon to open the search screen, then use the touch pad keys to enter the recipe name.
  - Touch the left arrow icon or the right arrow icon to navigate between recipe pages.
- Load food into the oven.

NOTE: Some recipes include the preheat function. Make sure the desired preheat temperature has been reached before loading food into the oven.

- Touch the icon for the selected recipe. The oven begins cooking.

NOTE: To stop cooking program at any time, touch the red stop icon .

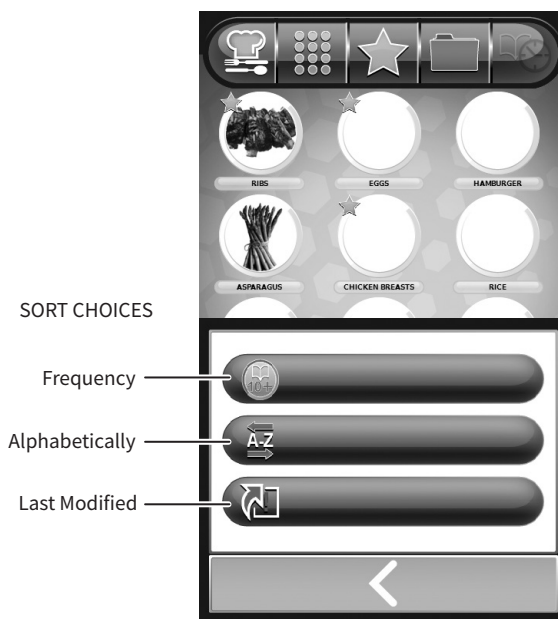





### Editing Programmed Recipes

The CT PROformance™ recipes that have been programmed can be edited, saved as a favorite recipe, and organized in folders or by time day they are used to help speed the search for specific recipes.

#### To Change Saved Recipes:

 Touch Recipe Utility icon located at the bottom of the recipe page.

The recipe utility screen is bright red to indicate that the user is now in edit mode.

 Touch the edit recipe icon.

Touch the icon of the recipe to be edited.

The first cooking step of the recipe will be displayed. Change cooking mode, temperature, time, probe temperature, and /or any of the auxiliary functions.

If an additional step needs to be added, touch

 Append to add next step

 Change the previous step

 Insert a step

 Edit as necessary. When there are no further changes to be made, touch the Save icon.

Enter the name of the recipe if it is to be changed.

 Touch the green check mark key to confirm change.

#### To Delete Saved Recipes:

 Touch Recipe Utility icon located at the bottom of the recipe page.

The recipe utility screen is bright red to indicate that the user is now in Edit Mode.

 Touch the Delete Recipe icon.

Touch the icon of the recipe to be deleted.

The recipe will be removed from the screen.

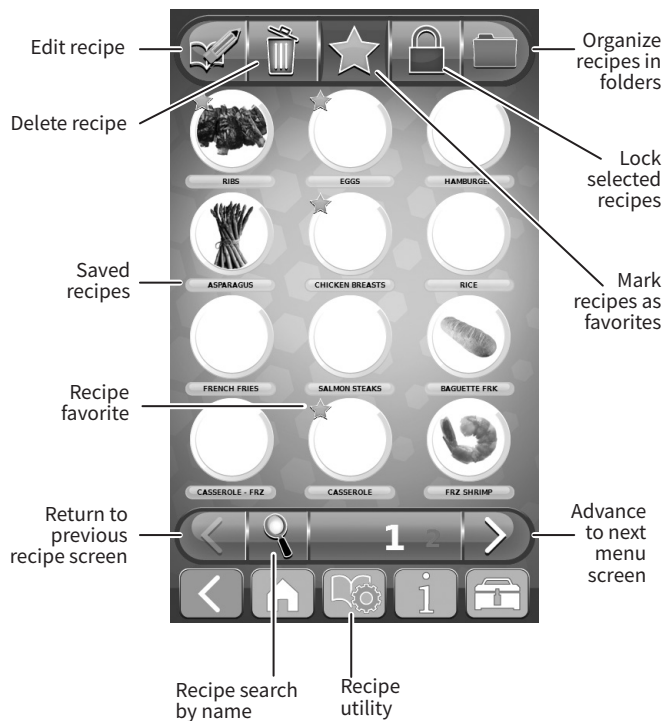
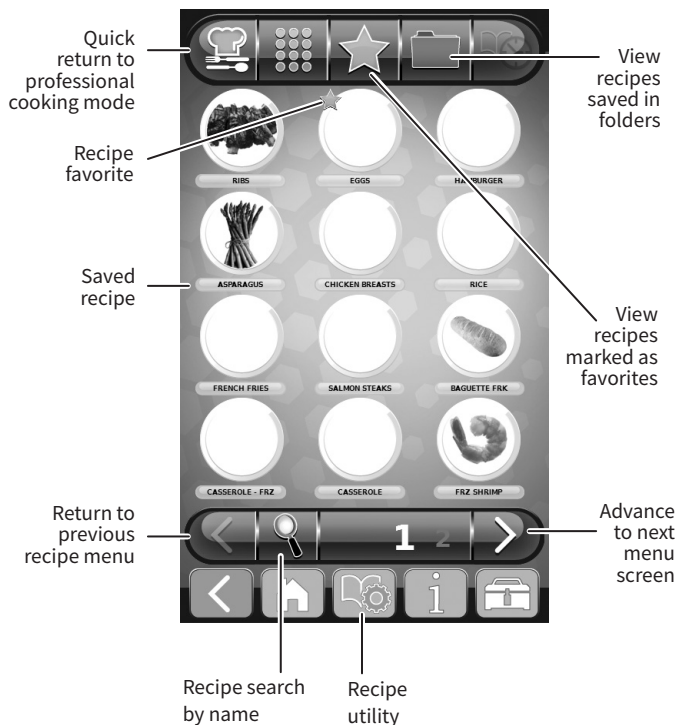

**NOTICE:** Each recipe can have up to 10 sequential steps.

(continued on next page)

## Organizing Programmed Recipes

The CT PROformance™ recipes that have been programmed can be organized in folders to help your kitchen staff be more productive.

### To Create A Recipe Folder:

 Touch the folder icon located at the top of the recipe page.

The recipe utility screen is bright red to indicate that the user is now in edit mode.

 Touch the add folder icon.

The keyboard will appear - allowing you to enter in a name for the recipe folder.

 Touch the green check mark to confirm the folder name.

Continue to add recipe folders as necessary.

 Touch the recipe utility icon to add programmed recipes to the folder.

 Touch the folder icon on the red background.

Touch the named folder icon to reveal the programmed recipe choices available.

Touch each of the programmed recipes to be added to the folder.

A small blue folder will appear on the lower left of the recipe icon, indicating that it has been selected to be added to the recipe folder.

 Touch the return to previous screen icon when your choices have been completed.

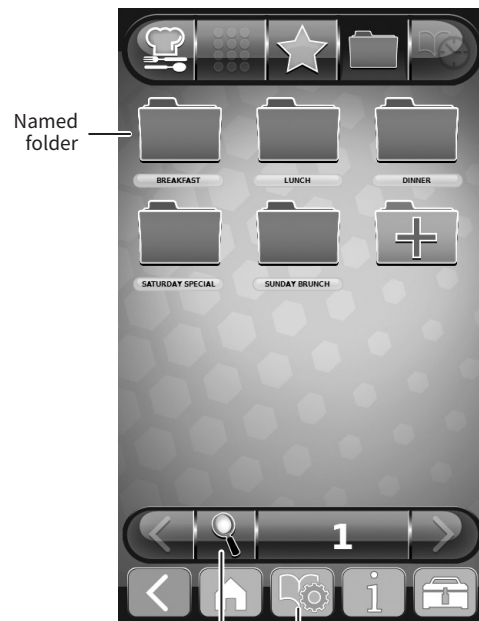
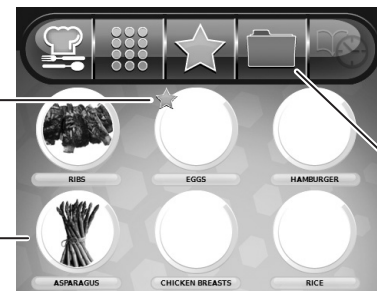

Folder search by name

Recipe utility

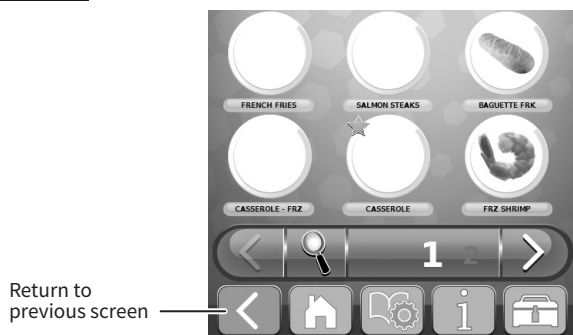

Organizing Programmed Recipes (Continued From Previous Page)

To Mark Saved Recipes as a Favorite:



Touch the Favorites recipe icon.

Touch the icon of the recipe to be marked.

A gold star will appear at the top left of the recipe icon. All favorites can be viewed when you touch the gold star while viewing the list of saved recipes.

To Lock Saved Recipes:



Touch the lock recipe icon.

Touch a single icon of the recipe or a group of icons to be locked.

A red lock will appear at the top right of the recipe icon.





## HACCP Access

The Combitherm CT PROformance™ oven meets the requirements of established HACCP criteria by providing automated sampling, record keeping, set-point validation, recipe used, dates and time. Data is captured when Core Temperature Probe cooking method is chosen. The information can be viewed on screen for verification or troubleshooting. The HACCP preview page will be displayed in LIFO (last in, first out) order. This data is retained indefinitely - until the information is downloaded. Once downloaded, the information is removed from the ovens memory. Best practice would be to download the information every 30 days to a USB stick. This information can then be copied to your computer. The file format is text (.txt).

**CAUTION:** The Combi Oven USB port is not recommended for use with personal hand held devices.

### To Access the Data Collected:

-  Touch the utilities icon located on the home page.
-  Touch the upload/download icon.
-  Touch the HACCP USB icon.

The HACCP screen can help diagnose a problem or error code if limited information is available.

*(next steps continued on next page)*

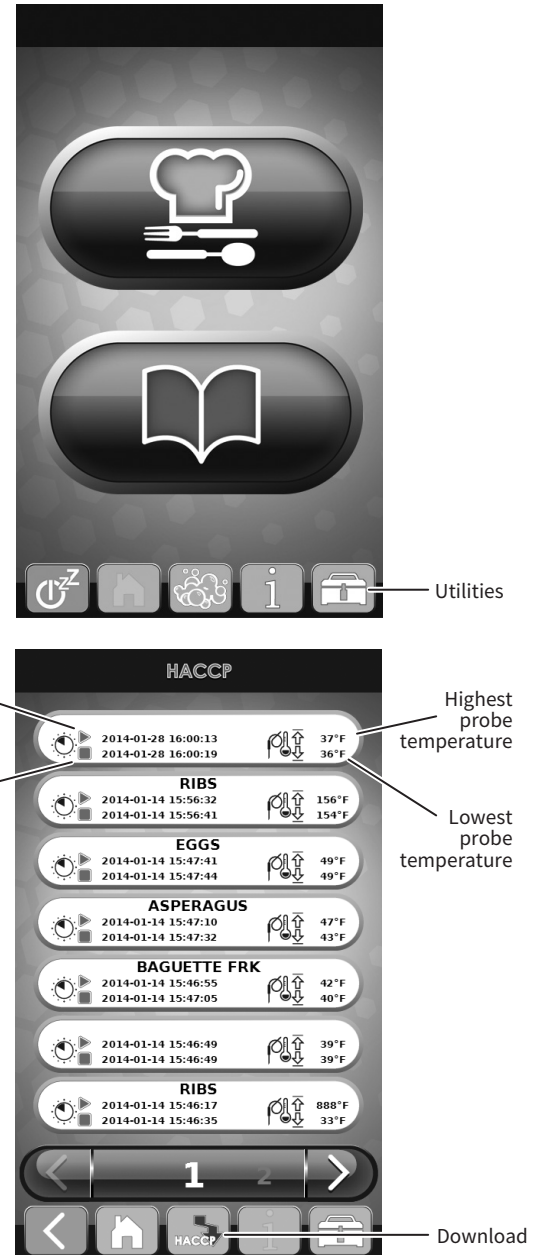

(steps continued from previous page)

**HACCP Access And Download**

UNIT ID	10:07:66:A5:36:DD				
IB	0.9	←			
CB	0.57	←			
OB	0.06	←			
Firmware versions					
RECIPE NAME	VEG BLANCH				
DATE	Time	PROGRAM NAME	COOK MODE	CAVITY SETPOINT (°F)	COOK TIME (hh:mm:ss)
10/31/2013	17:49:14	Preheat	Continuous	212	--:--
10/31/2013	17:59:27	Steam	Time	212	0:04:00
10/31/2013	18:00:27	Steam	Time	212	0:04:00
10/31/2013	18:01:28	Steam	Time	212	0:04:00
10/31/2013	18:02:29	Steam	Time	212	0:04:00
10/31/2013	18:03:29	Steam	Time	212	0:04:00
PROBE SETPOINT (°F)	Cavity Temperature (°F)	Core Temperature (°F)	Door Open	RECIPE STEP	
100	---	---	0	1	
110	---	---	0	2	
110	---	---	0	2	
110	---	---	0	2	
110	---	---	0	2	
110	---	---	0	2	

UNIT ID	10:07:66:A5:36:DD				
IB	0.9	←			
CB	0.57	←			
OB	0.06	←			
Firmware versions					
RECIPE NAME	VEG BLANCH				
DATE	Time	PROGRAM NAME	COOK MODE	CAVITY SETPOINT (°F)	COOK TIME (hh:mm:ss)
10/31/2013	17:49:14	Preheat	Continuous	212	--:--
10/31/2013	17:59:27	Steam	Time	212	0:04:00
10/31/2013	18:00:27	Steam	Time	212	0:04:00
10/31/2013	18:01:28	Steam	Time	212	0:04:00
10/31/2013	18:02:29	Steam	Time	212	0:04:00
10/31/2013	18:03:29	Steam	Time	212	0:04:00
PROBE SETPOINT (°F)	Cavity Temperature (°F)	Core Temperature (°F)	Door Open	RECIPE STEP	
100	---	---	0	1	
110	---	---	0	2	
110	---	---	0	2	
110	---	---	0	2	
110	---	---	0	2	
110	---	---	0	2	

**To Download the Data Collected:**

Pull back the cap of the USB port on the oven.

Insert the USB stick. The USB stick, if recognized, will automatically take the user to the download page. If the USB stick is not recognized by the Combitherm oven, a question mark will appear on screen. Try again with another flash drive device or call Alto-Shaam Service.

When the data has made a successful transfer to the USB drive, the screen will change. See below.

The download process will automatically create a folder on the USB stick titled "HACCP". Each text file contains cooking program specifics and each function the oven performed.

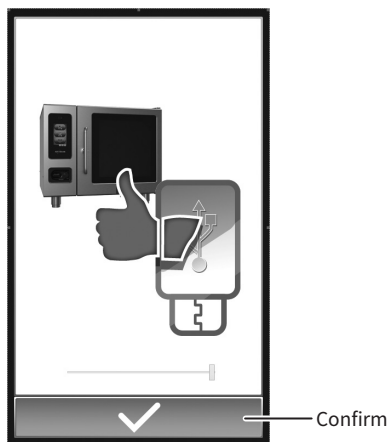

Touch the green Check Mark icon to complete the process.

Remove the USB stick and close the cap on the USB port on the oven.

## CombiHood PLUS™ Ventless Hood

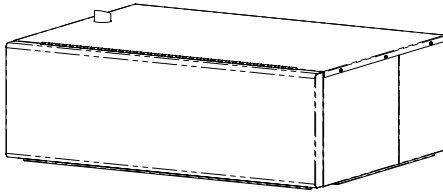

The CombiHood PLUS option is factory installed directly on the top of the Alto-Shaam Combitherm CTP or CTC series oven.

- Using EPA method 202 testing, grease laden vapors emitted by the Combi Ventless hood are 0.58 mg/m<sup>3</sup> – far less than U.L.’s established standard of 5 mg/m<sup>3</sup>.
- A high-powered fan moves all steam and vapors from the oven cavity into the hood intake and out the back exhaust vent, trapping grease as the air moves through the filter system.
- As steam and vapors are circulated through the hood, condensed steam drains at the back of the hood.
- An activated charcoal filter cleans the air before venting it out the back of the hood.
- CombiHood PLUS™ performance is “smart”; engaging the fan during the last two minutes of the cook cycle, which provides quiet operation and consumes less power.

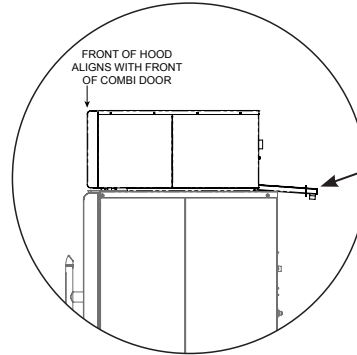

### Condensate Drain

A condensate drain line to the floor drain must be installed. The drain line must always be a positive gradient away from the Combitherm oven.

Test the drain for proper drainage and signs of leaking on a monthly basis.

To access the filters, swing the outer door up until the hinges latch in place. Then turn the three thumb screws ① one quarter-turn to release the inner door.

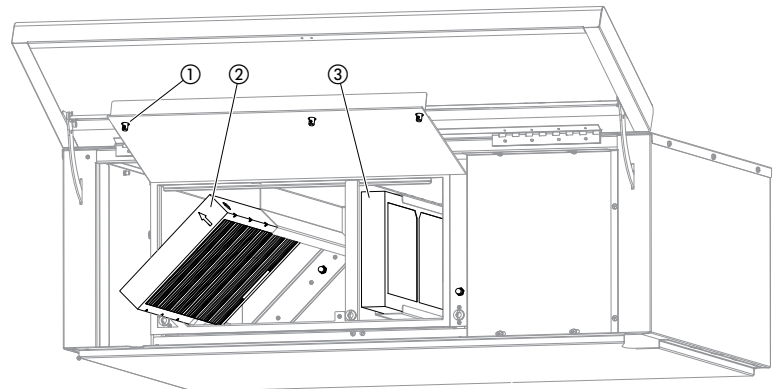

### ② CombiHood Plus Washable Grease Filter with metal housing (5017362)

Washing frequency should be based on oven usage with a maximum of two weeks between cleaning if the oven is used for non-grease laden products or steam applications only. Grease laden products require cleaning frequency of at least once a week.

Remove the grease filter by pulling it straight out of the housing. Place the filter in the dishwasher or wash separately by placing in hot, soapy water until all grease and particles have been removed. Rinse thoroughly. Allow the filter to air dry before reinstalling.

The air flow arrow on the filter casing should point toward the hood fan when the filter is reinstalled.

### ③ CombiHood Plus Charcoal Filter with paper housing, Class II (FI-25866)

CombiHood Plus Charcoal Filter with metal housing, Class I required for New York City and Los Angeles (FI-36620)

The charcoal filter should be inspected once a month for contaminants. Replacement must be made at a minimum of three month intervals — more often if heavy contaminants are visible or if the filter no longer controls odors.

To remove the filter, pull and slide out while holding the bottom housing. When replacing the filter, make certain the air flow arrow(s) point toward the hood fan, and that the filter is replaced in the three-sided metal frame provided with the hood.

**NOTICE:** A pressure switch is used to detect when the airflow through the charcoal filter is reduced by 25% - indicating a possible blockage. This will generate an E101 error message on the oven control display. The filters will need to be cleaned or replaced.

If the washable filter is not seated properly, an error code E102 appears on the oven control display during the selftest at the beginning of a cooking cycle or during the last two minutes of a cooking cycle.

When an E101 or E102 appears on the control display, a cook cycle cannot be started until the cause of the fault has been fixed.

## How To Use the Combilatch™ Door Interlock

The Combilatch™ door interlock is typically installed as an add-on to ovens that feature the CombiHood PLUS™ ventless hood. The interlock activates when the door handle is turned, and holds the oven door in a latched, partially open position. The default delay is 20 seconds. This allows the CombiHood to fully capture and remove the steam, fumes and vapors from the oven cavity before the door opens fully.

The Combilatch is installed at the factory. The latch a is located on the bottom of the oven.

NOTE: The delay time can be set to a value lower than 20 seconds during installation.

To open the oven door

1. Turn the door handle clockwise a quarter turn. The oven door opens to the latched position.
2. Wait until the latch delay is complete. The oven door opens fully.

NOTE: The pull ring b, which is mounted below the right side panel of the oven, can be used to open the oven door before the latch delay is complete.

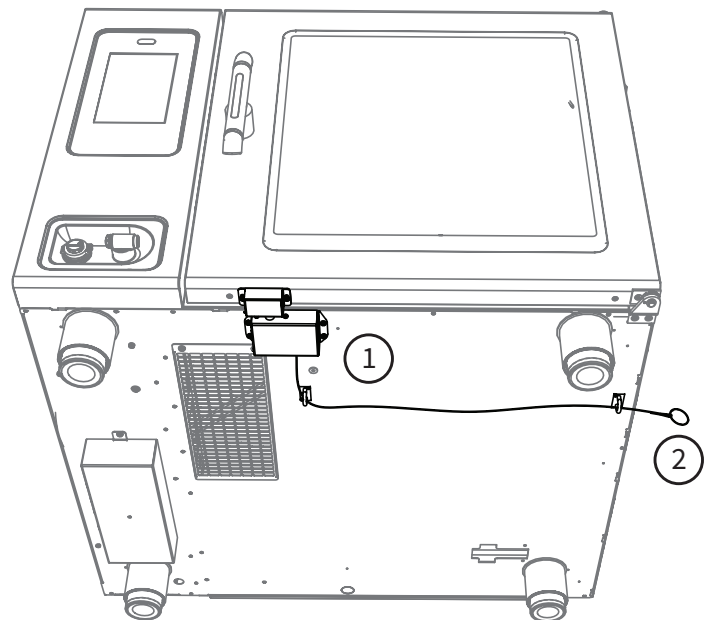

**SPECIAL CONDITIONS FOR UNITS INSTALLED WITHIN THE CITY OF NEW YORK**

1. Installation and start up must be performed by an Alto-Shaam authorized installation company.
2. Operating instructions in the manual must be read and understood by all persons using the appliance. The person responsible for training of the operators is responsible for the safekeeping of the manual.
3. A ventless hood condensate drain line to the floor drain shall be installed as applicable. The drain line must always be a positive gradient away from the Combitherm.
4. The grease filter shall be cleaned at least once a week. The disposable dry-type air filter should be inspected for contaminants on a regular basis. Replacement must be made at a minimum of three month intervals. A hood maintenance log must be included with the unit and shall be completed at the intervals indicated.
5. The filter interlocks shall be inspected/tested at least every 6 months.
6. Suitable fire protection shall be provided for each installation. This protection system is subject to FDNY Range Hood Inspection Unit's inspection and approval.
7. Installation, maintenance, and cleaning procedures shall comply with all applicable New York City Fire Code, New York City Electric Code, Construction Codes (including the Building Code and the Mechanical Code), rules and regulations.
8. Underwriters Laboratories, Inc.'s listing requirements and limitations shall be complied with and manufacturer's installation, maintenance procedures and safety limitations shall be complied with.
9. The ductless hood and Combitherm unit shall be used for light duty cooking only and the entire ductless hood on a combi oven with grease filter I air filter shall be inspected, cleaned and replaced if necessary, by qualified person holding a Certificate of Fitness type W-64 or F-64. A record of such inspection and cleaning shall be kept on the premises for inspection.
10. Certificate of Approval number shall be plainly and permanently labeled upon the appliance.
11. All installations shall be subject to inspection by representatives of the Bureau of Fire Prevention which may result in added requirements being imposed.
12. The Fire Department reserves the right to make periodic inspections of the above referenced ductless hood on a combi oven without warning to ensure that maintenance requirements are being followed. These audit inspections will be solely at the discretion of the Fire Department.

**HOW TO TEST THE FILTER INTERLOCKS**

1. Start the oven and set the temperature to 500°F.
2. Set the timer to three minutes and allow the oven to run for 90 seconds.
3. Verify that the hood is operating (Listen for noise from fan.)
4. Open the hood door.
5. Loosen the three quarter-turn screws on the filter access door and open the filter access door.
6. Observe the controller screen. An E101 or E102 error code displays.
7. Close the filter access cover.
8. Close the hood door.
9. Press the checkmark button to clear the error codes.



## Connecting the Optional Grease Collection System

- Grease Collection Hose Assembly is attached to the oven in the back.
- The hose guide bracket can be attached on either the left side or the right side toward the back. Placement on the left side is recommended whenever possible. Thumb screws are in position for this purpose. Remove thumb screws, position hose guide bracket and secure screws (photo A). Thread grease hose through the guide.
- The hose hanger bracket can be attached on either the left side or the right side toward the front of the oven. Placement on the left side is recommended whenever possible. Philips screws are in position beneath the oven for this purpose. Remove Philips screws, position hose hanger bracket and secure screws (photo B). The hanger bracket is used to secure the grease collection hose while changing grease collection containers.
- Place Grease Collection Containers inside the tray of the Mobile Grease Collection Cart. Roll into place next to the oven and apply the caster brake.
- Loosen vent cap on container. Pull out the Grease Collection Hose Assembly from the back of the unit. Remove collection container fill cap (photo C).
- Screw Grease Collection Hose Assembly on to collection container until snug.
- Turn ball valve handle to the ON position.
- If this auxiliary function has been chosen while setting your cooking mode, the automatic grease collection system is electronically activated during the cooking process [u.s. patent 8,997,730 b2]. It is designed to save labor and provide greater employee safety by eliminating the need to handle hot grease in shallow pans.
- Grease Collection container has a 5 gallon (19 liter) capacity and holds approximately 3 full loads of poultry grease.
- At a minimum, empty and clean the container when material reaches the fill line on the bottle or at 4 gallons to avoid hot grease overflow.
- Turn the ball valve handle to the OFF position.
- The ball valve handle must be in the OFF position when changing the collection container.
- Unscrew the container fill cap.
- Using a new container, screw Grease Collection Hose Assembly on to collection container until snug.
- Turn ball valve handle to the ON position.

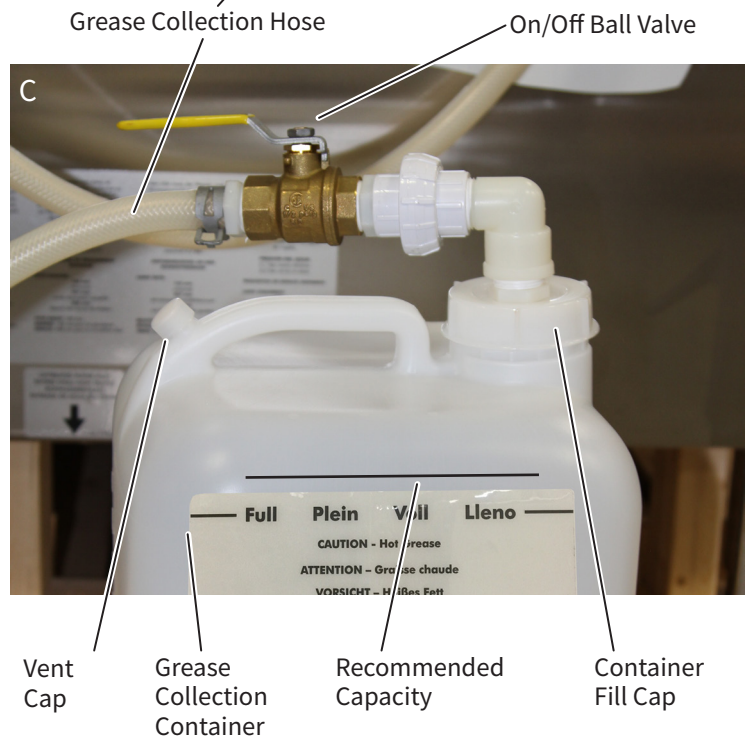
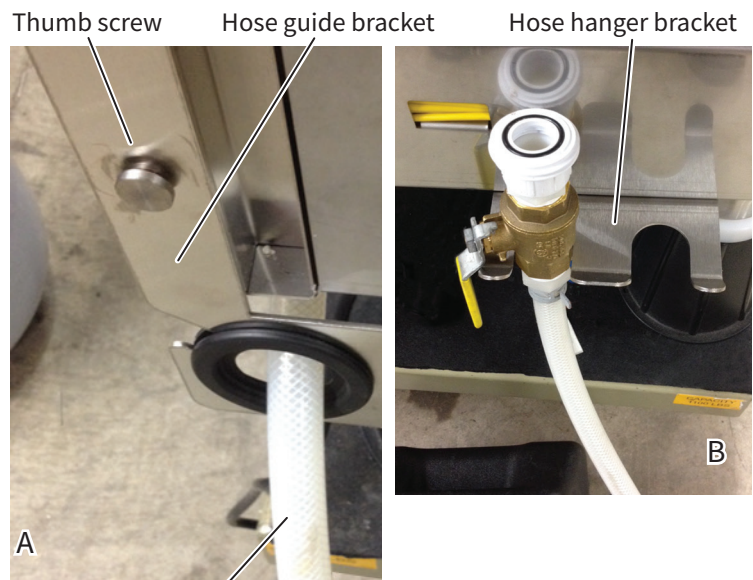

### **⚠ WARNING**

To prevent **SERIOUS INJURY** or **PROPERTY DAMAGE**:

**ALWAYS** apply caster brakes on mobile carts, appliances, or accessories when stationary. Equipment on casters can move or roll on uneven floors.

Check grease collection connections and replace the containers when filled to the recommended capacity.

## Connecting the Optional Liquid Cleaner

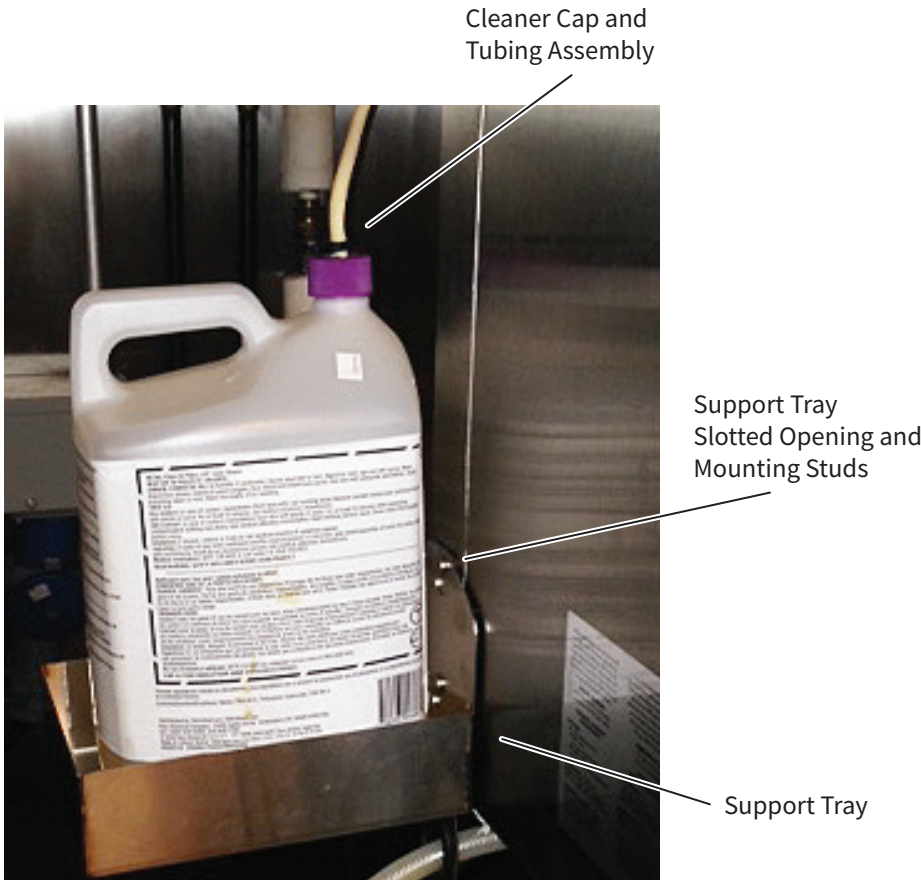

- Removable, cleaner support tray can be mounted on the left or right exterior wall of the oven. Slide slotted openings on the tray over the mounting studs.
- Support tray holds a 2-1/2-gallon (9,5 liter) bottle and measures 10-1/2" x 7-3/4" (267mm x 194mm).
- Place liquid oven cleaner bottle inside tray.
- ❖ Wearing protective rubber gloves and eye wear, remove cap from liquid oven cleaner bottle. Pull out the Cleaner Cap and Tubing Assembly from the back of the unit screw on to liquid oven cleaner bottle.
- ❖ Position cap to ensure the hose is not kinked after tightening.
- Combitherm liquid oven cleaner jugs are quickly and easily replaced.
- Combitherm liquid oven cleaner is automatically pumped through the system, saving labor and providing greater employee safety by eliminating the need to handle caustic cleaning liquids each day.

**⚠ WARNING**

ALWAYS wear protective eye wear and rubber gloves when using liquid oven cleaner to prevent eye, skin, and respiratory tract irritation.

Keep out of reach of children.

See Safety Data Sheet for additional information.

**⚠ WARNING**

To prevent **SERIOUS INJURY** or **DEATH**, NEVER operate this appliance in a cleaning mode without the liquid cleaner connected, with a kink in the cleaning hose line, or with an empty liquid cleaner container. Failure to do so may result in poor oven cleaning, grease and/or carbon accumulating inside the oven cavity and increased risk of fire.





























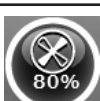



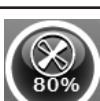









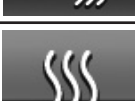

**⚠ WARNING**

To prevent **serious personal injury, death, or property damage:**



The appliance must be cleaned thoroughly to avoid deposits of grease and or food residues inside the appliance that may catch fire. If fat deposits and/or food waste inside the appliance ignite, shut down the appliance immediately and keep the appliance door closed to extinguish the fire. If further extinguishing is required, disconnect the appliance from the main power and use a fire extinguisher (do not use water to extinguish a grease fire!). Failure to clean the appliance properly invalidates the warranty and relieves Alto-Shaam of all liability.

















































Bakery Items

RECIPE	STEP		COOKING MODE	COOK TEMP	TIME / PROBE	FAN SPEED	SMOKE	HUMIDITY LEVEL	POWER LEVEL
Bakery (retherm)	--	275°F (135°C)		275°F (135°C)	4 minutes		--		
Brownies	--	325°F (163°C)		325°F (163°C)	25 minutes		--		
Cinnamon Rolls	--	350°F (177°C)		350°F (177°C)	6 minutes		--		
Cookies (not frozen)	--	325°F (163°C)		325°F (163°C)	12 minutes		--		
Croissants	Step 1	340°F (171°C)		340°F (171°C)	20 seconds		--		
	Step 2	--		340°F (171°C)	11 minutes		--		
Danish Pastry	--	340°F (171°C)		340°F (171°C)	11 minutes		--		
Dinner Rolls	--	350°F (177°C)		350°F (177°C)	10 minutes		--		
French Bread	--	350°F (177°C)		350°F (177°C)	16 minutes		--		
Fruit Pie	--	350°F (177°C)		350°F (177°C)	50 minutes		--		
Muffins	--	325°F (163°C)		325°F (163°C)	20 minutes		--		

## Bakery Items (Continued)

RECIPE	STEP		COOKING MODE	COOK TEMP	TIME / PROBE	FAN SPEED	SMOKE	HUMIDITY LEVEL	POWER LEVEL
Par-baked Baguette (Frozen)	Step 1	450°F (232°C)		400°F (204°C)	2 minutes		--		
	Step 2	--		400°F (204°C)	20 seconds		--		
	Step 3	--		400°F (204°C)	7 minutes		--		
Par-baked Bread	--	350°F (177°C)		350°F (177°C)	10 minutes		--		
Par-baked Rolls	--	350°F (177°C)		350°F (177°C)	10 minutes		--		
Proofing	--	--		90°F (32°C)	30 minutes		--		
Puff Pastry	--	375°F (191°C)		375°F (191°C)	14 minutes		--		
Sheet Cake	--	325°F (163°C)		325°F (163°C)	20 minutes		--		

Convenience Product Items

RECIPE	STEP		COOKING MODE	COOK TEMP	TIME / PROBE	FAN SPEED	SMOKE	HUMIDITY LEVEL	POWER LEVEL
Chicken Wings - Thawed	--	400°F (204°C)		400°F (204°C)	10 minutes		--		
Corn Dogs - Frozen	--	300°F (149°C)		300°F (149°C)	9 minutes		--		
Egg Rolls	--	375°F (191°C)		375°F (191°C)	15 minutes		--		
Entrée (4 lb frozen)	--	350°F (177°C)		300°F (149°C)	50 minutes		--		
Entrée (4 lb refrigerated)	--	350°F (177°C)		350°F (177°C)	Probe 165°F (74°C)		--		
French Fries - Frozen - 1/2" crinkle cut	Step 1	475°F (246°C)		375°F (191°C)	1 minute		--		
	Step 2	--		375°F (191°C)	9 minutes		--	--	
Hamburger Patties - Frozen	--	350°F (177°C)		350°F (177°C)	12 minutes		--		
Hamburger Patties - Precooked & Grilled	--	350°F (177°C)		350°F (177°C)	6 minutes		--		
Hamburger Patties - Thawed	--	350°F (177°C)		350°F (177°C)	5 minutes		--		
Mini Pizza 5"	--	350°F (177°C)		350°F (177°C)	10 minutes		--		
Pizza - Fresh	--	575°F (301°C)		550°F (288°C)	3 minutes 30 seconds		--		













































## Convenience Product Items (Continued)

RECIPE	STEP		COOKING MODE	COOK TEMP	TIME / PROBE	FAN SPEED	SMOKE	HUMIDITY LEVEL	POWER LEVEL
Spring Rolls - Frozen	--	350°F (177°C)		350°F (177°C)	15 minutes		--		
Tater Tots	--	375°F (191°C)		375°F (191°C)	10 minutes		--		

## Fish & Seafood Items

RECIPE	STEP		COOKING MODE	COOK TEMP	TIME / PROBE	FAN SPEED	SMOKE	HUMIDITY LEVEL	POWER LEVEL
Baked Fish - Fresh	--	575°F (301°C)		550°F (288°C)	4 minutes		--		
Lobster - Whole	--	135°F (57°C)		195°F (91°C)	13 minutes		--		
Salmon - Cold Smoked	Step 1	--		--	15 minutes				
	Rest	--	STANDBY	--	30 minutes	OFF	OFF	--	OFF
Salmon Filets	--	105°F (41°C)		145°F (63°C)	7 minutes		--		
Salmon Steaks	--	105°F (41°C)		145°F (63°C)	8 minutes		--		
Cold Smoked Shrimp - Pre-cooked	--	--		--	10 minutes				
Shrimp - Frozen	--	118°F (48°C)		158°F (70°C)	12 minutes		--		

Meat Recipes





































RECIPE	STEP		COOKING MODE	COOK TEMP	TIME / PROBE	FAN SPEED	SMOKE	HUMIDITY LEVEL	POWER LEVEL
Bacon	--	318°F (159°C)		318°F (159°C)	15 minutes		--		
Beef Brisket - Smoked	--	250°F (121°C)		250°F (121°C)	Probe 180°F (82°C)				
Beef - Roasted (Prime Rib, Top Round, Tri-Tips, etc)	--	--	Combi Delta-T	125°F (52°C)	Probe 125°F (52°C)		--		
Breakfast Sausage Links	--	350°F (177°C)		350°F (177°C)	8 minutes		--		
Ham by Core Temp	--	--	Combi Delta-T	125°F (52°C)	Probe 150°F (66°C)		--		
Leg of Lamb by Core Temp	--	--	Combi Delta-T	125°F (52°C)	Probe 130°F (54°C)		--		
Meat Loaf by Core Temp	--	275°F (135°C)		275°F (135°C)	Probe 155°F (68°C)		--		
Pork - Back Ribs - Raw	--	250°F (121°C)		250°F (121°C)	1 hour 15 minutes		--		
Pork - Back Ribs - Smoked	Step 1	250°F (121°C)		250°F (121°C)	1 hour 15 minutes				
	Step 2	--		160°F (71°C)	Continuous		OFF		
Pork - Loin - by Core Temp	--	300°F (149°C)		300°F (149°C)	Probe 150°F (66°C)		--		

## Meat Recipes (Continued)

RECIPE	STEP		COOKING MODE	COOK TEMP	TIME / PROBE	FAN SPEED	SMOKE	HUMIDITY LEVEL	POWER LEVEL
Pork Ribs Reheat	--	400°F (204°C)		400°F (204°C)	7 minutes		--		
Pork Shoulder - Smoked	Step 1	225°F (107°C)		225°F (107°C)	90 minutes				
	Step 2	--		225°F (107°C)	Probe 180°F (82°C)		OFF		
Rack of Lamb - by Core Temp	--	--	Combi Delta-T	122°F (50°C)	Probe 130°F (54°C)		--		
Sausage - Fresh	--	120°F (49°C)		160°F (71°C)	15 minutes		--		

























Miscellaneous Recipes

RECIPE	STEP		COOKING MODE	COOK TEMP	TIME / PROBE	FAN SPEED	SMOKE	HUMIDITY LEVEL	POWER LEVEL
Crème Brûlée	--	190°F (88°C)		190°F (88°C)	55 minutes		--		
Eggs - Hardboiled	--	212°F (100°C)		212°F (100°C)	12 minutes		--		
Eggs - Poached in Poaching Pan	--	130°F (54°C)		170°F (77°C)	10 minutes		--		
Eggs - Scrambled in bag: shake at 18 minutes	--	212°F (100°C)		212°F (100°C)	25 minutes		--		
Eggs - Scrambled in pan	--	212°F (100°C)		212°F (100°C)	15 minutes		--		
Eggs - Sous Vide	--	--		148°F (64°C)	60 minutes		--		
Pasta - Linguine or Spaghetti	--	212°F (100°C)		212°F (100°C)	20 minutes		--		
Rice	--	212°F (100°C)		212°F (100°C)	23 minutes		--		
Tamales	--	212°F (100°C)		212°F (100°C)	30 minutes		--		

## Poultry Recipes

RECIPE	STEP		COOKING MODE	COOK TEMP	TIME / PROBE	FAN SPEED	SMOKE	HUMIDITY LEVEL	POWER LEVEL
Chicken - Patties	Step 1	350°F (177°C)		350°F (177°C)	4 minutes		--		
	Step 2	--		350°F (177°C)	5 minutes		--	--	
Chicken - Pieces		350°F (177°C)		350°F (177°C)	35 minutes		--		
Chicken - Oven Fried Pieces		450°F (232°C)		450°F (232°C)	18 minutes		--		
Chicken Pieces - MRB		350°F (177°C)		350°F (177°C)	28 minutes		--		
Chicken - Whole Roasted (full load)		575°F (301°C)		400°F (204°C)	Probe 175°F (79°C)		--		
Chicken - Whole Roasted (half load)		400°F (204°C)		400°F (204°C)	Probe 175°F (79°C)		--		
Chicken - Whole Smoked	Step 1	--		34°F (1°C)	15 minutes				
	Step 2	--		400°F (204°C)	Probe 175°F (79°C)		OFF		
Duck Whole - by Core Temp	Step 1	250°F (121°C)		250°F (121°C)	15 minutes		--		
	Step 2	--		300°F (149°C)	10 minutes		--		
	Step 3	--		300°F (149°C)	Probe 175°F (79°C)		--		













Poultry Recipes (Continued)

RECIPE	STEP		COOKING MODE	COOK TEMP	TIME / PROBE	FAN SPEED	SMOKE	HUMIDITY LEVEL	POWER LEVEL
Grilled Chicken Breasts		575°F (301°C)		465°F (240°C)	4 minutes		--		
Turkey Breast	Step 1	350°F (177°C)		250 - 350°F (135 - 177°C)	5 minutes		--		
	Step 2	--		250 - 350°F (135 - 177°C)	Probe 165°F (74°C)		--		
Turkey Breast - Smoked	Step 1	275°F (135°C)		275°F (135°C)	60 minutes				
	Step 2	--		275°F (135°C)	Probe 155°F (68°C)		OFF		

## Vegetable Recipes

RECIPE	STEP		COOKING MODE	COOK TEMP	TIME / PROBE	FAN SPEED	SMOKE	HUMIDITY LEVEL	POWER LEVEL
Asparagus - Fresh	--	150°F (66°C)		190°F (88°C)	3 minutes		--		
Asparagus - Roasted	--	575°F (301°C)		575°F (301°C)	5 minutes		--		
Broccoli, Cauliflower, Squash, Zucchini - Fresh	--	212°F (100°C)		212°F (100°C)	3 - 6 minutes		--		
Cabbage, Green Beans, - Fresh	--	212°F (100°C)		212°F (100°C)	8 -10 minutes		--		
Carrots - Fresh	--	225°F (107°C)		225°F (107°C)	10 minutes		--		
Cauliflower - Roasted	Step 1	575°F (301°C)		475°F (246°C)	4 minutes		--		
	Step 2	--		430°F (221°C)	5 minutes		--		
Corn-on-the-Cob - Fresh	--	212°F (100°C)		212°F (100°C)	14 minutes		--		
Frozen Vegetables	--	300°F (149°C)		220°F (104°C)	8 minutes		--		
Mushrooms - button - roasted	Toss with oil - place on sheet pan	575°F (301°C)		550°F (288°C)	10 minutes		--		

Vegetable Recipes (Continued)

RECIPE	STEP		COOKING MODE	COOK TEMP	TIME / PROBE	FAN SPEED	SMOKE	HUMIDITY LEVEL	POWER LEVEL
Potatoes, for mashed	--	225°F (107°C)		225°F (107°C)	30 minutes		--		
Potatoes, Red or Salad	--	212°F (100°C)		212°F (100°C)	30 minutes		--		
Potatoes, Roasted	--	500°F (260°C)		450°F (232°C)	18 minutes		--		

## CombiClean® Cleaning Agents

### **DANGER**

ALWAYS wear rubber gloves when using CombiClean tablets or spray oven cleaner.

### **DANGER**

ALWAYS wear protective eye wear when using spray oven cleaner.

## Danger

- May be harmful if swallowed.
- May be harmful in contact with skin. Always wear rubber gloves when handling.
- Causes severe skin burns and eye damage.
- Tablet will begin to dissolve onto skin if handled with damp or wet hands.
- May cause respiratory irritation. May cause drowsiness or dizziness.
- Harmful to aquatic life with long lasting effects. Do not mix with anything but water.
- Do not breathe dust/fumes/gas/mist/vapors/spray. Wash face, hands and any exposed skin thoroughly after handling. Wear protective gloves/protective clothing/eye protection/face protection.
- Use only outdoors or in a well-ventilated area. Avoid release to the environment. Store in a locked and well ventilated place. Keep container tightly closed. Dispose of contents/container to an approved waste disposal plant.

## First Aid

Immediately call a POISON CENTER or doctor/physician. Specific treatment (See section 4 on the SDS).

- **IF IN EYES:** Rinse cautiously with water for several minutes. Remove contact lenses, if present and easy to do. Continue rinsing. Immediately call a POISON CENTER or doctor/physician.
- **IF ON SKIN (or hair):** Remove/Take off immediately all contaminated clothing. Rinse skin with water/shower. Wash contaminated clothing before reuse.
- **IF INHALED:** Move victim to fresh air and keep at rest in a position comfortable for breathing. Immediately call a POISON CENTER or doctor/physician if you feel unwell.
- **IF SWALLOWED:** Rinse mouth. DO NOT induce vomiting. Drink 2-3 glasses of water or milk. Immediately call a POISON CENTER or doctor/physician.

**Preventative Maintenance**

In addition to the routine cleaning and maintenance procedures, there are several additional steps to be taken for both sanitation and to keep the oven running efficiently. Refer to the following inspection checklists for a comprehensive approach to longevity and equipment efficiency. These additional safeguards will help prevent down time and costly repairs.

**Do not dispose of grease, fat, wood chips or solid waste down the oven drain.**

Fats and solids will eventually coagulate in the drain system, causing blockage. Consequently, water will back-up into the condenser and interior oven compartment, resulting in an oven that is inoperable.

**Make certain the drain screen is always in place. Remove any solid waste material from the oven bottom and drain screen before it enters the drain system.**

The routine removal of solids from the drain screen will help prevent blockage.

**Use the authorized combitherm oven cleaner only.**

The use of unauthorized cleaning agents may discolor or harm the interior surfaces of the oven.

**To prolong the life of the door gasket, clean this item daily.**

The acids and related compounds found in fat, particularly chicken fat, will weaken the composition of the gasket unless cleaned on a daily basis. Wipe with a hot, soapy cloth.

**To additionally protect gasket life, allow oven door to remain slightly open at the end of the production day.**

An open door will relieve the pressure on the door gasket.

**Routinely clean door hinges.**

Open oven door to relieve tension. Clean all parts of the hinge.

**On a monthly basis, decalcify or descale the oven.**

Using the Scale Free cleaner, CE-27889, place 7 ounces of the product in the drain. Run a heavy-duty cleaning cycle. After the cleaning cycle has been completed, use the hand shower to spray down the oven interior. Swing open the interior fan guard and spray down the area behind the panel. Direct a stream of water down the interior drain cover to thoroughly rinse the cleaner out of the oven. After the oven interior has been sprayed down, run a rinse cleaning cycle.

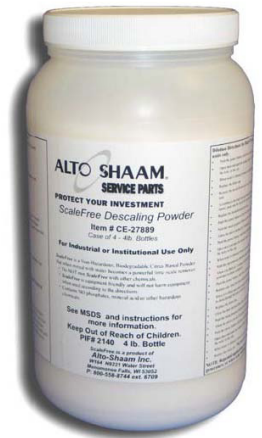

**WARNING**

When smoking is completed, remove the smoker box. Dispose of wood chips in a fire proof waste receptacle to prevent the risk of fire.



**WARNING**



To prevent serious personal injury, death, or property damage:

**Do not** steam clean, hose down or flood the interior or exterior with water or liquid solution of any kind. **Do not** use water jet to clean. Failure to observe this precaution will void the warranty.

## Weekly Maintenance

On a weekly basis, the heat exchanger on gas models and convection elements on electric models must be inspected.

- Remove all wire shelves from inside the appliance.
- Remove left side rack from the oven cavity.
- Flip the tabs or loosen the thumb screws on the fan panel to the open position and swing the fan guard cover plate toward the back of the oven.
- Inspect the heat exchanger on gas models for signs of grease and/or carbon buildup, scale buildup, and any signs of major deformation. Refer to images A and B.
- Inspect that the flue pipe seal is tight and intact. Refer to image C.
- Inspect the convection elements for signs of cracking, grease and/or carbon buildup, scale buildup, and any signs of major deformation. Refer to image D.

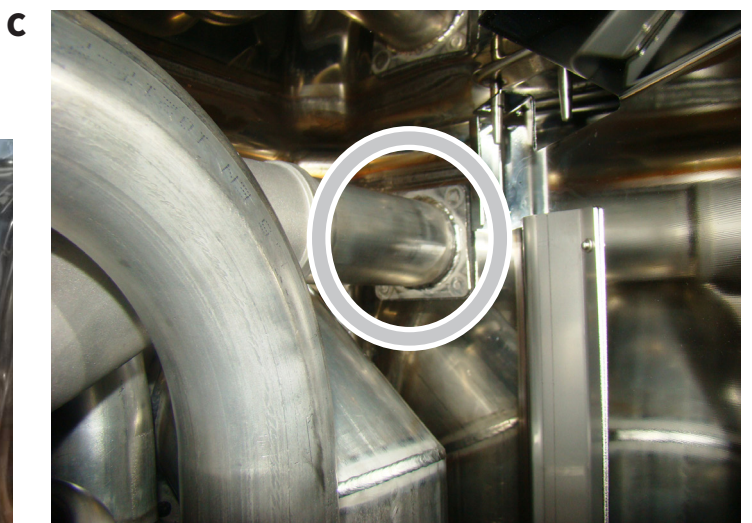
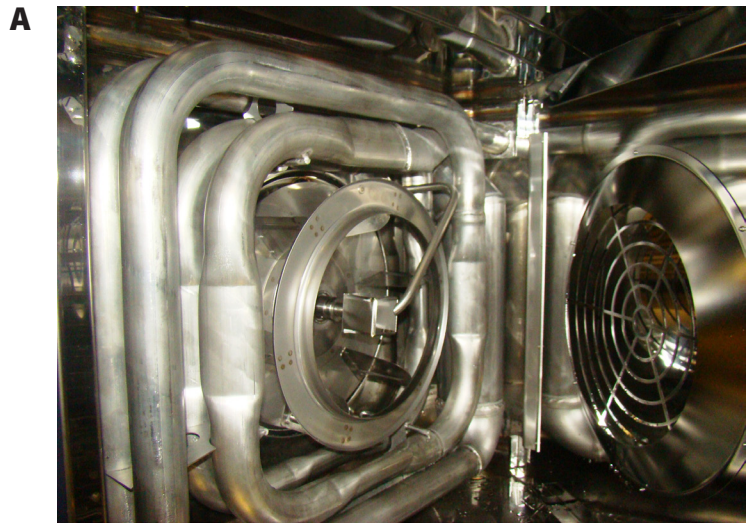



Daily Inspection

Unit Information

Business Name: \_\_\_\_\_

Serial Number: \_\_\_\_\_

Model Number: \_\_\_\_\_

Daily Inspection Start Date: \_\_\_\_\_

Daily Inspection Checklist

	Monday	Tuesday	Wednesday	Thursday	Friday	Saturday	Sunday
Inspect and clean:							
Product probe (thermometer)							
Door gasket (inner door seal)							
Inner door glass							
Front drip tray							
Screen and overlay (inspect for cracks, peeling, moisture, etc.)							
Execute automatic wash cycle (with approved cleaning chemical ONLY)							
Employee initials							

Component Malfunction and Replacement

List details of the failure(s) next to the day they occurred. Leave blank if components are working properly.	
Monday	
Tuesday	
Wednesday	
Thursday	
Friday	
Saturday	
Sunday	

## Weekly Inspection

### Unit Information

**Business Name:** \_\_\_\_\_

**Serial Number:** \_\_\_\_\_

**Model Number:** \_\_\_\_\_

**Weekly Inspection Start Date:** \_\_\_\_\_

### Weekly Inspection Checklist

Inspect - Oven cavity lamp	
Inspect - Oven cavity for signs of grease/carbon buildup	
Inspect - Loosen thumb screws to inspect behind the fan panel inside the oven cavity for signs of grease/carbon buildup	
Inspect - Loosen thumb screws to inspect behind the fan panel inside the oven cavity for signs of scale buildup	
<b>G</b> Inspect - The heat exchanger for any signs of major deformation. If yes, immediately remove from service and take corrective action steps.	
<b>G</b> Inspect - The heat exchanger for any loose/disconnected pipes or flanges. If yes, immediately remove from service and take corrective action steps.	
<b>E</b> Inspect - Convection elements for signs of cracking, deformation, or damage	
Clean ventless hood grease filters	
Employee initials	

**G** Gas units only

**E** Electric units only

### Component Malfunction and Replacement

List details of the failure(s) next to the day they occurred. Leave blank if components are working properly.	
Week 1	
Week 2	
Week 3	
Week 4	

Monthly Inspection

**Unit Information**

**Business Name:** \_\_\_\_\_

**Serial Number:** \_\_\_\_\_

**Model Number:** \_\_\_\_\_

**Monthly Inspection Start Date:** \_\_\_\_\_

**Monthly Inspection Checklist**

Inspect/Test - Proper draining of the oven cavity	
Inspect - All drain lines for leaks or clogs	
<b>EB</b> Descale the steam generator	
Inspect - Oven cavity for any signs of scale buildup	
Descale the oven interior	
Inspect ventless hood paper filter (replace as needed)	
Test ventless hood drain for proper drainage and signs of leaking	
Employee initials	

**EB** Electric boiler units only

**Component Malfunction & Replacement**

Summarize any component failure(s) that may have occurred during this month.

## Yearly Inspection

### Unit Information

**Business Name:** \_\_\_\_\_

**Serial Number:** \_\_\_\_\_

**Model Number:** \_\_\_\_\_

**12-Month Inspection Start Date:** \_\_\_\_\_

### 12-Month Inspection Checklist

Replace - Steam bypass hose	
Inspect - Cleaning pump hose	
Inspect/Test - Proper draining of the oven cavity	
Inspect - All drain lines for leaks or clogs	
Inspect - All solenoid hoses (both ends)	
Inspect - Upper browning valve hose	
Inspect - Low pressure relief valve & hose	
<b>E</b> Inspect - Convection element seal (from the electrical compartment)	
<b>G</b> Inspect - Gas heat exchanger seal (from the electrical compartment)	
Inspect - N6 oven temperature probe seal	
<b>EB</b> Descale the steam generator	
<b>EB</b> Remove & Inspect - Steam generator elements	
Inspect - Hand shower hose	
Inspect - Hand shower handle	
Inspect - Product probe	
Inspect - Water injection tube	
Inspect - Oven cavity for any signs of scale buildup	
Inspect - Oven cavity lamp	
Inspect - Oven cavity for signs of grease/carbon buildup	
Inspect - Behind the fan panel inside the oven cavity for signs of grease/carbon buildup	
Inspect - Behind the fan panel inside the oven cavity for signs of scale buildup	

**EB** Electric boiler units only     **G** Gas units only     **E** Electric units only

**Unit Information**

**Business Name:** \_\_\_\_\_

**Serial Number:** \_\_\_\_\_

**Model Number:** \_\_\_\_\_

**12-Month Inspection Start Date:** \_\_\_\_\_

**12-Month Inspection Checklist**

<b>G</b> Inspect - The heat exchanger for any signs of major deformation. If yes, immediately remove from service and take corrective action steps.	
<b>G</b> Inspect - The heat exchanger for any loose/disconnected pipes or flanges. If yes, immediately remove from service and take corrective action steps.	
<b>G</b> Inspect and Ensure - Exhaust pipes are exiting the oven cavity	
<b>G</b> Inspect - Heat exchanger flange gasket (replace as needed)	
<b>G</b> Inspect and Tighten - Heat exchanger flange bolts	
<b>G</b> Inspect and Tighten - Heat exchanger burner flange hardware & gasket (replace as needed)	
<b>G</b> Inspect and Tighten - Heat exchanger igniter flange hardware & gasket (replace as needed)	
<b>G</b> Inspect - Heat exchanger exhaust pipes (ensure they are exiting out past the oven cavity ceiling flange) - ESG models only	
<b>G</b> Inspect - Oven cavity ceiling flange & flange gasket - ESG models only	
<b>G</b> Tighten - Burner flange bolts	
<b>G</b> Tighten - Igniter flange bolts	
Inspect - Heat exchanger weep holes to ensure they are free of obstructions (if the hole is obstructed, immediately remove oven from service and replace the heat exchanger) - Not applicable to CTP/CTC models	
<b>E</b> Inspect - Convection elements for signs of cracking, deformation, or damage	
Replace - Oven lamp cover(s) & gasket(s)	
Descale the oven interior	
Inspect - Upper and lower door hinges and pins	
Inspect - Door gasket (replace as needed)	
Inspect - Door upper and lower hinges (replace as needed)	
Wipe the inner door glass	
Inspect - Front drip tray (clean as needed)	
Inspect - Front drip tray hose	
Inspect - Control overlay	
Inspect and Tighten - All electrical connections	
Inspect and Tighten - All cooling fans for proper operation	

**EB** Electric boiler units only      **G** Gas units only      **E** Electric units only

**Unit Information**

**Business Name:** \_\_\_\_\_

**Serial Number:** \_\_\_\_\_

**Model Number:** \_\_\_\_\_

**12-Month Inspection Start Date:** \_\_\_\_\_

**12-Month Inspection Checklist**

Inspect and Tighten - Door hinges and lower hinge pin bolt	
Inspect and Tighten - Door handle	
If there is a smoker, inspect the smoke element for visual signs of deformation, cracks or breaks (replace as needed)	
Review - Error code history	
Note the software version (update if not current)	
Record - Water pressure (static & dynamic)	
Record - Line voltage across all lines	
Record - Line voltage to ground on each line	
Record - Amperage across all three legs (when heating)	
Function test all components (list components)	
For ovens shipped to New Zealand or Australia, inspect the backflow preventer check valve per AS/NZ3500.1 and AS/NZ3500.2	

**Component Failure and Replacement**

Summarize any component failure(s) that may have occurred during this month.

**Customer Signature:** \_\_\_\_\_

**Technician Signature:** \_\_\_\_\_

### Protecting Stainless Steel Surfaces



It is important to guard against corrosion in the care of stainless steel surfaces. Harsh, corrosive, or inappropriate chemicals can completely destroy the protective surface layer of stainless steel. Abrasive pads,

steel wool, or metal implements will abrade surfaces causing damage to this protective coating and will eventually result in areas of corrosion. Even water, particularly hard water that contains high to moderate concentrations of chloride, will cause oxidation and pitting that result in rust and corrosion. In addition, many acidic foods spilled and left to remain on metal surfaces are contributing factors that will corrode surfaces.

Proper cleaning agents, materials, and methods are vital to maintaining the appearance and life of this appliance. Spilled foods should be removed and the area wiped as soon as possible but at the very least, a minimum of once per day. Always thoroughly rinse surfaces after using a cleaning agent and wipe standing water as quickly as possible after rinsing.

### Cleaning Agents

Use non-abrasive cleaning products designed for use on stainless steel surfaces. Cleaning agents must be chloride-free compounds and must not contain quaternary salts. Never use hydrochloric acid (muriatic acid) on stainless steel surfaces. Failure to observe this precaution will void the warranty. Always use the proper cleaning agent at the manufacturer's recommended strength. Contact your local cleaning supplier for product recommendations.

### Cleaning Materials

Cleaning can usually be accomplished with the proper cleaning agent and a soft, clean cloth. When more aggressive methods are needed, use a non-abrasive scouring pad on difficult areas and make certain to scrub with the visible grain of surface metal to avoid surface scratches. Never use wire brushes, metal scouring pads, or scrapers to remove food residue. Failure to observe this precaution will void the warranty.

<b>NOTICE</b>	
<p>No scrapers</p>	<p>To protect stainless steel surfaces, completely avoid the use of abrasive cleaning compounds, chloride based cleaners, or cleaners containing quaternary salts. <b>Never</b> use hydrochloric acid (muriatic acid) on stainless steel. <b>Never</b> use wire brushes, metal scouring pads or scrapers.</p>
<p>No wire brushes</p>	
<p>No steel pads</p>	

<b>WARNING</b>	
	<p>To prevent <b>serious personal injury, death, or property damage:</b></p> <p>The appliance must be cleaned thoroughly to avoid deposits of grease and or food residues inside the appliance that may catch fire. If fat deposits and/or food waste inside the appliance ignite, shut down the appliance immediately and keep the appliance door closed to extinguish the fire. If further extinguishing is required, disconnect the appliance from the main power and use a fire extinguisher (do not use water to extinguish a grease fire!). Failure to clean the appliance properly invalidates the warranty and relieves Alto-Shaam of all liability.</p>

**! WARNING**

To prevent serious personal injury, death, or property damage:

**Do not** steam clean, hose down or flood the interior or exterior with water or liquid solution of any kind. **Do not** use water jet to clean. Failure to observe this precaution will void the warranty.

### Daily Cleaning of the Oven

Cleaning is to be performed at the end of the production day or between production shifts.

1. Allow the oven to cool.
2. Remove the optional grill grate from the oven interior and wash separately in hot, soapy water to preserve the special non-stick coating.
3. Release the hinged inner glass on the CoolTouch3™ triple pane window door. Clean both sides of each pane of glass with a window cleaner or vinegar.
4. Wipe the control panel and door handle thoroughly.
5. Use the optional Drip Tray Clean-out Brush [5021126] to remove grease and food debris from the drip tray drain line. Insert brush first, and push into the drip tray drain opening until 6" (152mm) or less remains of the wire handle. Remove the brush and repeat as necessary.
6. Clean the door gasket. Wipe the gasket and crevices with a clean cloth soaked in non-abrasive cleaning agent. Wipe again with a cloth and clean rinse water. Certain conditions will accelerate the wear of the door seal and routine cleaning will prolong the life of the door gasket:
  - continuous operation at high cooking temperatures
  - use of low humidity levels
  - production with predominantly high-fat foods

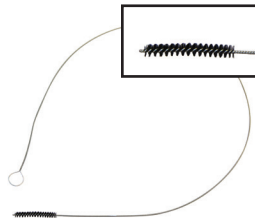

Do not attempt to remove the gasket or place in the dishwasher.

7. To help maintain the protective film coating on polished stainless steel, clean the exterior of the appliance with a cleaner recommended for stainless steel surfaces. Spray the cleaning agent on a clean lint-free cloth and wipe with the grain of the stainless steel.

### Probe and Probe Prong Cleaning

1. Remove all food debris from the probe between loads and at the end of each production shift. Wipe the entire probe, probe cable assembly, probe prongs, and probe holding bracket with a clean cloth and warm detergent solution.
2. Remove detergent by wiping the probe, cable, probe prongs, and bracket with a cloth and clean rinse water.
3. Wipe the probe and probe bracket with a disposable alcohol pad or sanitizing solution recommended for food contact surfaces.
4. Allow the probe, probe prongs, and cable to air dry in the probe holding bracket.
5. Wipe the probe with a disposable alcohol pad prior to inserting into a new food product.

### Roll-In Cart/Food Trolley Cleaning

1. Move the food trolley to a cart wash area. Clean the food trolley with a mild, non-abrasive cleaning detergent and warm water.
2. Hand wipe all framing, slides, drip pan, and base. Thoroughly clean debris from the casters. A spray hose can be used to clean the food trolley.
3. Remove detergent solution with warm water.
4. Wipe or spray with a sanitizing solution designed for use on metal and vinyl food contact surfaces.
5. Allow the food trolley to air dry.

As an alternative, food trolleys can be cleaned while inside the oven. Allow the trolley to remain in the oven through the heavy-duty cleaning cycle, followed by steps 2 through 5.

### Monthly Cleaning

- spray head
- water intake filters
- drain pipe
- decalcify (descale) oven



CT PROtouch™ with CombiClean®

Five (5) cleaning levels are offered: rinse (20 minutes), light (30 minutes), normal (1 hour 20 minutes), heavy-duty (2 hours 6 minutes), and heavy-duty PLUS (3 hours 30 minutes) cleaning. CombiClean® 18 gram CombiTabs™ (CE-36354) or Combitherm® liquid spray cleaner (CE-24750) may be used. Side racks and shelves may remain inside oven during cleaning. Remove the optional Grill Grate from the oven interior and wash separately in hot, soapy water to preserve the special non-stick coating. Remove the smoker tray and any solid wastes from the drain screen and oven interior to prevent blockage.

**NOTICE:** If a power outage were to occur during any of the cleaning cycles, the oven will begin a six (6) minute forced-rinse cycle.

Be sure the water is turned on.



Touch the Cleaning icon found on the home screen.

If oven is too hot to proceed, the **Oven Too Hot** warning screen will appear. Open the oven door to allow the oven to cool below 150°F (66°C). When the oven is finished cooling, begin the cleaning procedure again.



Rinse      Light      Normal      Heavy-duty      Heavy-duty PLUS

Select Rinse, Light, Normal, Heavy-duty, or Heavy-duty PLUS cleaning level.

- Wear rubber gloves to remove oven interior drain cover screen.
- Tear open or cut open the plastic wrap surrounding the cleaning tablets.
- Remove tablets from the packaging. Discard packaging. Insert the appropriate number of CombiClean® CombiTabs™ directly into the oven cavity drain or spray CombiClean liquid cleaner inside the oven.
- The number of tablets to be used can be increased depending upon how dirty the interior is.
- Close oven door.



Touch the green check mark key to begin the cleaning cycle.

Oven shuts down when the cleaning cycle is complete. Leave door slightly ajar when finished.

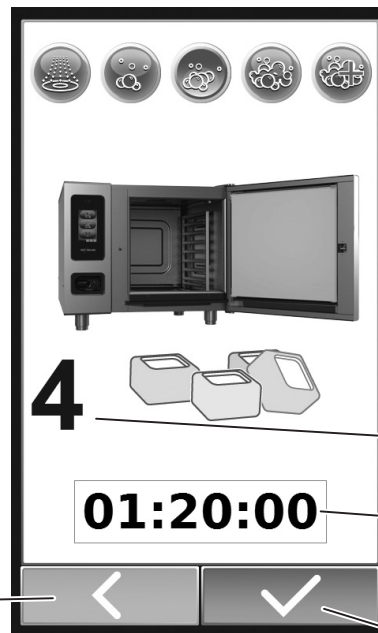

Return to previous screen

4

Number of tablets to use

01:20:00

Cleaning time needed

Begin cleaning cycle

**NOTICE:** If the oven is equipped with the optional grease collection system, 3 cleaning levels are available.

Wear rubber gloves

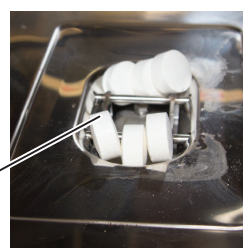
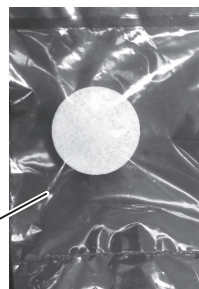

Drain opening



**NOTICE:** All tablets should be placed inside the drain as best as possible and drain screen re-installed before starting the cleaning cycle. Tablets placed on top of the drain cover or placed on the bottom of the oven will not dissolve properly and will cause the oven interior to deteriorate.

## CT PROtouch™ with Automatic Liquid Cleaning

There are five (5) cleaning levels for liquid cleaning.

- Rinse (20 minutes)
- Light (30 minutes)
- Normal (1 hour 20 minutes)
- Heavy-duty (2 hours 6 minutes)
- Heavy-duty PLUS (3 hours 30 minutes)

Use liquid cleaning solution (CE-36457) or Combitherm® liquid spray cleaner (CE-24750).

Side racks and shelves can remain inside the oven.

**NOTICE:** If a power outage happens during a cleaning cycle, the oven will begin a six (6) minute forced-rinse cycle the next time it starts.

**NOTICE:** Make sure the water is turned on and that enough liquid cleaner is available for the cleaning cycle.

### Steps

1. Remove the optional grill grate from the oven interior and wash separately in hot, soapy water to preserve the special non-stick coating.
2. Remove the smoker tray
3. Remove all solid waste from the drain screen and oven interior.
4. Touch the cleaning icon  on the home screen. The cleaning screen ① displays.

If the cavity temperature is above 150°F (66°C), the Oven Too Hot warning displays. Open the door and allow the oven to cool before selecting a cleaning level.

5. Make sure the liquid cleaner container is filled.



6. Select a cleaning level.
7. Touch the green check mark icon .

The oven shuts down when the cleaning cycle is complete. Leave the door open when the cleaning cycle is complete to speed drying.



Remaining cleaning time

Error Codes

ALWAYS check the circuit breaker is turned “ON” and your unit is receiving power BEFORE calling your Authorized Alto-Shaam Service Agent.

## NOTICE

This section is provided for the assistance of qualified and trained service technicians only and is not intended for use by untrained or unauthorized service personnel. Do not attempt to repair or service the oven beyond this point. Contact Alto-Shaam for the nearest authorized service agent. Repairs made by any other service agents without prior authorization by Alto-Shaam will void the warranty.

When the oven malfunctions, an error code will appear in the display.

 **Press the Start icon to acknowledge the error.**

When the oven error notification has been acknowledged, the Combitherm will attempt to return to normal operation.

Error Code	Error Call Out in Display	Description of Error	Possible Cause(s)
<b>E01</b>	Low Water Boiler	Upper water level probe B1 is not satisfied within 5 minutes, after water solenoid valve Y1 is activated.	<ul style="list-style-type: none"> <li>– Water supply is shut off.</li> <li>– Low water pressure.</li> <li>– Boiler drain cap is missing.</li> <li>– Boiler drain pump is defective.</li> <li>– Drain pump elbow leaking.</li> <li>– Water level probe has calcium build up.</li> <li>– Double water solenoid valve is defective (Y1).</li> <li>– Relay board, high voltage is defective.</li> </ul>
<b>E02</b>	Control Temperature High	Low voltage relay board temperature higher than 176°F (80°C).	<ul style="list-style-type: none"> <li>– Check wiring to all components listed below.</li> <li>– Cooling fan on relay board assembly is defective.</li> <li>– Cooling fan on display board assembly is defective.</li> <li>– Main cooling fan is defective.</li> <li>– Cooling fan on motor drive is defective.</li> </ul>
<b>E03</b>	Fan Motor Error	Fan motor does not spin after 60 seconds, detected by the Hall Sensor. Error 03 does not appear if error E53 is detected first.	<ul style="list-style-type: none"> <li>– Check wiring to all components listed below.</li> <li>– If LED on motor control flashes, see error codes for motor control.</li> <li>– Motor or fan wheel locked.</li> <li>– Hall sensor does not detect motor rotation.</li> <li>– Motor Thermo Temperature protection.</li> <li>– Fan wheel damaged.</li> </ul>
<b>E04</b>	Lower Fan Motor Error	Lower Fan motor does not spin after 60 seconds, detected by the Hall Sensor. Error 04 does not appear if error E54 is detected first.	<ul style="list-style-type: none"> <li>– Check wiring to all components mentioned below.</li> <li>– If LED on motor control flashes, see error codes for motor control.</li> <li>– Motor or fan wheel locked.</li> <li>– Hall sensor does not detect motor rotation.</li> <li>– Motor Thermo Temperature protection.</li> <li>– Fan wheel damaged.</li> </ul>
<b>E05</b>	VFD Comm Failure	When VFD does not respond to a query on the CAN interface.	<ul style="list-style-type: none"> <li>– Loss of power to VFD.</li> <li>– VFD malfunction.</li> <li>– CAN cable disconnected.</li> <li>– CAN address not correct on VFD.</li> </ul>

CONTINUED ON NEXT PAGE

## Error Codes

Error Code	Error Call Out in Display	Description of Error	Possible Cause(s)
<b>E06</b>	Lower VFD Comm Failure	When VFD does not respond to a query on the CAN interface.	<ul style="list-style-type: none"> <li>– Loss of power to VFD.</li> <li>– VFD malfunction.</li> <li>– CAN cable disconnected.</li> <li>– CAN address not correct on VFD.</li> </ul>
<b>E07</b>	Error Received from VFD	When VFD is flashing the green light	– Refer to VFD error code list and match to number of blinks on the green LED of VFD.
<b>E08</b>	Error Received from Lower VFD	When VFD is flashing the green light	– Refer to VFD error code list and match to number of blinks on the green LED of VFD.
<b>E11</b>	Convection Temperature High	<p>In Combination program, cavity temperature N6 is measuring in excess of 572°F (300°C) for a minimum of 25 seconds</p> <p>In Convection program, cavity temperature N6 is measuring in excess of 572°F (300°C) for a minimum of 25 seconds</p>	<ul style="list-style-type: none"> <li>– Check wiring to all components mentioned below.</li> <li>– Steam element contactor locked/on.</li> <li>– N6 oven cavity temperature probe is defective.</li> <li>– N6 oven cavity temperature probe wires connected backwards</li> <li>– Relay board, high voltage, defective.</li> </ul>
<b>E13</b>	Boiler Temperature High	Boiler temperature is more than 248°F (120°C) for more than 25 seconds, detected by B4 Probe	<ul style="list-style-type: none"> <li>– Calcium build up in boiler</li> <li>– Check wiring to all components mentioned below.</li> <li>– Steam element contactor locked/on.</li> <li>– B4 boiler temperature probe is defective.</li> <li>– B4 probe wires connected backwards</li> <li>– Water level probe has calcium build up.</li> </ul>
<b>E15</b>	Condensor Temperature High	Condensor water temperature is more than 212°F (100°C) for more than 180 seconds, detected by B3 probe	<ul style="list-style-type: none"> <li>– Water supply is shut off.</li> <li>– Check wiring to all components mentioned below.</li> <li>– B3 condensor temperature probe is defective.</li> <li>– B3 condensor probe wires connected backwards</li> <li>– Single water solenoid valve defective (Y2).</li> <li>– Relay board, high voltage, defective.</li> </ul>
<b>E20</b>	B11 Core Temperature Probe Single Point Fault	Single point core temperature probe defective or disconnected	<ul style="list-style-type: none"> <li>– Clean probe receptacle pins with sand paper.</li> <li>– B11 Single Point Core Temperature probe with quick connect defective.</li> <li>– B11 Single Point Core Temperature probe wires with quick connect disconnected.</li> <li>– B11 Single Point Core Temperature probe receptacle defective.</li> <li>– B11 Single Point Core Temperature probe receptacle wires disconnected.</li> </ul>
<b>E21</b>	N6 Cavity Probe Fault	Cavity temperature probe defective or disconnected	<ul style="list-style-type: none"> <li>– N6 oven cavity temperature probe defective.</li> <li>– N6 oven cavity temperature probe wires.</li> </ul>
<b>E22</b>	B10 Core Temperature Probe Multi-point Fault	Multipoint core temperature probe defective or disconnected	<ul style="list-style-type: none"> <li>– B10 multipoint core temperature probe defective.</li> <li>– B10 multipoint core temperature probe wires disconnected.</li> </ul>
<b>E23</b>	B4 Boiler Probe Fault	Boiler temperature probe defective or disconnected	<ul style="list-style-type: none"> <li>– B4 boiler temperature probe defective.</li> <li>– B4 probe wires connected backwards.</li> </ul>
<b>E24</b>	B5 Bypass Probe Fault	Bypass steam temperature probe defective or disconnected	<ul style="list-style-type: none"> <li>– B5 bypass steam temperature probe defective.</li> <li>– B5 bypass steam temperature probe wires connected backwards.</li> </ul>
<b>E25</b>	B3 Condensor Probe Fault	Condensor water temperature probe defective or disconnected.	<ul style="list-style-type: none"> <li>– B3 condensor temperature probe defective.</li> <li>– B3 condensor probe wires connected backwards.</li> </ul>
<b>E26</b>	B10 - Point 1 - Core Temperature Probe Multipoint Fault	Multipoint core temperature probe defective or disconnected.	<ul style="list-style-type: none"> <li>– B10 Multipoint Core Temperature probe defective.</li> <li>– B10 Multipoint Core Temperature probe wires disconnected.</li> </ul>
<b>E27</b>	B10 - Point 2 - Core Temperature Probe Multipoint Fault	Multipoint core temperature probe defective or disconnected.	<ul style="list-style-type: none"> <li>– B10 Multipoint Core Temperature probe defective.</li> <li>– B10 Multipoint Core Temperature probe wires disconnected.</li> </ul>

CONTINUED ON NEXT PAGE

## Error Codes

Error Code	Error Call Out in Display	Description of Error	Possible Cause(s)
<b>E28</b>	B10 - Point 3 - Core Temperature Probe Multipoint Fault	Multipoint core temperature probe defective or disconnected.	<ul style="list-style-type: none"> <li>– B10 Multipoint Core Temperature probe defective.</li> <li>– B10 Multipoint Core Temperature probe wires disconnected.</li> </ul>
<b>E29</b>	B10 - Point 4 - Core Temperature Probe Multipoint Fault	Multipoint core temperature probe defective or disconnected.	<ul style="list-style-type: none"> <li>– B10 Multipoint Core Temperature probe defective.</li> <li>– B10 Multipoint Core Temperature probe wires disconnected.</li> </ul>
<b>E34</b>	Steam Generator Drain Pump Fault	If water level does not drop below lower water level probe after three minutes when steam generator drain pump is activated in cleaning program.	<ul style="list-style-type: none"> <li>– Calcium build up in steam generator drain pump.</li> <li>– Boiler drain pump defective.</li> <li>– Relay board, high voltage, defective.</li> <li>– Water level probe defective.</li> </ul>
<b>E36</b>	Steam Temperature High	<p>In Steam program, cavity temperature N6 is measuring in excess of 395°F (200°C) for more than 60 seconds.</p> <p>In Combination program, cavity temperature N6 is measuring in excess of 520°F (270°C), for more than 60 seconds.</p> <p>In Retherm program, cavity temperature N6 is measuring in excess of 395°F (200°C), for more than 60 seconds.</p> <p>In Cleaning program, cavity temperature N6 is measuring in excess of 395°F (200°C), for more than 60 seconds.</p>	<ul style="list-style-type: none"> <li>– Water supply is shut off.</li> <li>– Low water pressure.</li> <li>– Water injection pipe, calcium build up.</li> <li>– Water flow valve defect or calcium build up.</li> <li>– Double water solenoid valve defective (Y1).</li> <li>– Relay board, high voltage, defective.</li> </ul>
<b>E40</b>	B3 Fault	B3 probe shorted to ground	– Defective or miswired probe.
<b>E41</b>	B4 Fault	B4 probe shorted to ground	– Defective or miswired probe.
<b>E42</b>	B5 Fault	B5 probe shorted to ground	– Defective or miswired probe.
<b>E43</b>	N6 Fault	N6 probe shorted to ground	– Defective or miswired probe.
<b>E44</b>	N8 Fault	N8 probe shorted to ground	– Defective or miswired probe.
<b>E45</b>	B10 Fault	B10 probe shorted to ground	– Defective or miswired probe.
<b>E46</b>	B10 - Point 1 Fault	B10 probe shorted to ground	– Defective or miswired probe.
<b>E47</b>	B10 - Point 2 Fault	B10 probe shorted to ground	– Defective or miswired probe.
<b>E48</b>	B10 - Point 3 Fault	B10 probe shorted to ground	– Defective or miswired probe.
<b>E49</b>	B10 - Point 4 Fault	B10 probe shorted to ground	– Defective or miswired probe.
<b>E51</b>	No Water In Boiler	Lower water level probe B2 is not satisfied within 5 minutes, after water solenoid valve Y1 is activated	<ul style="list-style-type: none"> <li>– Water supply is shut off.</li> <li>– Low water pressure.</li> <li>– Boiler drain cap missing.</li> <li>– Boiler drain pump defective.</li> <li>– Drain pump elbow leaking.</li> <li>– Water level probe has calcium build up.</li> <li>– Double water solenoid valve defective (Y1).</li> <li>– Relay board, high voltage, defective.</li> </ul>
<b>E53</b>	Fan Motor High Temperatures	Fan motor does not spin, result in over-heating, detected by motor coil safety thermo element. Temperature more than 320°F (160°C).	<ul style="list-style-type: none"> <li>– Motor high limit open or wired incorrectly.</li> <li>– If LED on motor control flashes, see error codes for motor control.</li> <li>– Motor or fan wheel locked.</li> <li>– Fan wheel damaged.</li> </ul>
<b>E54</b>	Lower Fan Motor High Temperature	Lower fan motor does not spin, result in over-heating, detected by motor coil safety thermo element. Temperature more than 320°F (160°C).	<ul style="list-style-type: none"> <li>– Motor high limit open or wired incorrectly.</li> <li>– If LED on motor control flashes, see error codes for motor control.</li> <li>– Motor or fan wheel locked.</li> <li>– Fan wheel damaged. <b>CONTINUED ON NEXT PAGE</b></li> </ul>

## Error Codes

Error Code	Error Call Out in Display	Description of Error	Possible Cause(s)
<b>E55</b>	Vent Not Open (Lower vent on dual vent system)	60 seconds after the venting motor is activated the vent motor safety switch did not open.	<ul style="list-style-type: none"> <li>– Alignment issue between motor cam and vent motor safety switch (micro switch).</li> <li>– Faulty vent valve (motor).</li> <li>– Faulty vent valve safety switch (micro switch).</li> </ul>
<b>E56</b>	Vent 2 Not Open (Upper vent on dual vent system)	60 seconds after the venting motor is activated the vent motor safety switch did not open.	<ul style="list-style-type: none"> <li>– Alignment issue between motor cam and vent motor safety switch (micro switch).</li> <li>– Faulty vent valve (motor).</li> <li>– Faulty vent valve safety switch (micro switch).</li> </ul>
<b>E57</b>	No Rinse Water	Flow switch for solenoid valve Y4 does not detect any water flow for a minimum of 60 seconds.	<ul style="list-style-type: none"> <li>– Water supply is shut off.</li> <li>– Low water pressure.</li> <li>– Flow switch is dirty or defective.</li> <li>– Double water solenoid valve defective (Y3).</li> <li>– Relay board, high voltage, defective.</li> </ul>
<b>E88</b>	Lower Gas Ignition Failure  NOTE: If after 2 attempts to clear this error, the error appears a third time, remove the oven from service and immediately contact an Alto-Shaam authorized service provider.	Reset output from Ignition Module is ON	<ul style="list-style-type: none"> <li>– Hot surface ignitor not functioning.</li> <li>– No gas supply.</li> <li>– Flame sensor not functioning.</li> <li>– Faulty ignition control.</li> </ul>
<b>E89</b>	Upper Gas Ignition Failure  NOTE: If after 2 attempts to clear this error, the error appears a third time, remove the oven from service and immediately contact an Alto-Shaam authorized service provider.	Reset output from Ignition Module is ON	<ul style="list-style-type: none"> <li>– Hot surface ignitor not functioning.</li> <li>– No gas supply.</li> <li>– Flame sensor not functioning.</li> <li>– Faulty ignition control.</li> </ul>
<b>E90</b>	Lower Gas Combustion Blower Not at Speed	Speed is too slow.	<ul style="list-style-type: none"> <li>– Power supply cable is not connected to blower motor.</li> <li>– Speed control cable is not connected to blower motor.</li> <li>– Blower motor is blocked, rotation is impeded, or motor is faulty.</li> <li>– Faulty control board.</li> </ul>
<b>E91</b>	Upper Gas Blower Not at Speed	Speed is to slow.	<ul style="list-style-type: none"> <li>– Power supply cable is not connected to blower motor</li> <li>– Speed control cable is not connected to blower motor</li> <li>– Blower motor is blocked, rotation is impeded, or motor is faulty</li> <li>– Faulty control board</li> </ul>
<b>E92</b>	Communication Error CB does not properly respond	Twelve (12) instances of no-response from the relay board (CB) to the display board (IB).	<ul style="list-style-type: none"> <li>– Check CAN cable connections.</li> <li>– CAN cable defective.</li> <li>– Relay board, low voltage, connector defective.</li> <li>– Display board connector defective.</li> </ul>
<b>E93</b>	Interface Board (IB) and Control Board (CB) are in different states	The IB is in a different running state than the CB for more than 20 seconds.	<ul style="list-style-type: none"> <li>– Check CAN cable connections.</li> <li>– CAN cable defective.</li> <li>– Relay board, low voltage, connector defective.</li> <li>– Display board connector defective.</li> </ul>
<b>E94</b>	Communication Error, TO Interface Board	No signal transfer for more than 20 seconds between the Interface Board (IB) and the Control Board (CB).	<ul style="list-style-type: none"> <li>– Check CAN cable connections.</li> <li>– CAN cable defective.</li> <li>– Relay board, low voltage, connector defective.</li> <li>– Display board connector defective.</li> </ul>

CONTINUED ON NEXT PAGE

## Error Codes

Error Code	Error Call Out in Display	Description of Error	Possible Cause(s)
<b>E100</b>	One or more maintenance reminder has timed out.	When any maintenance reminder has expired without action having been taken by the operator.	<ul style="list-style-type: none"> <li>– Enter maintenance reminder screen and address the item that has timed out and reset</li> </ul>
<b>E101</b>	Ventless Hood Fault - No Pressure	If the power switch or pressure switch is not closed.	<ul style="list-style-type: none"> <li>– Check power switch is on.</li> <li>– Check vent motor is turning in the proper direction.</li> <li>– Pressure switch is miss wired or defective.</li> <li>– Filter(s) require cleaning or replacement</li> </ul>
<b>E102</b>	Ventless Hood Fault — Filters Not Present	If the air filter switches are not closed.	<ul style="list-style-type: none"> <li>– Check filters are installed and properly seated.</li> <li>– Check filter switches are not damaged, defective or dislodged.</li> </ul>
<b>E103</b>	Option Board Doesn't Send Switch Setting	OB not communicating its switch settings to the CB.	<ul style="list-style-type: none"> <li>– Check CAN cable connection between OB and CB.</li> <li>– Ensure CB dip switch is set to see an OB.</li> <li>– Incompatible OB and CB software (update software).</li> <li>– OB defective.</li> <li>– CB defective.</li> </ul>
<b>E104</b>	Option Board Not Communicating	Option board is not communicating with CB.	<ul style="list-style-type: none"> <li>– Check option board CAN connection at CB and OB.</li> <li>– Defective OB.</li> <li>– Defective CB.</li> </ul>
<b>E105</b>	No or Low Water Pressure	Water pressure switch not activated.	<ul style="list-style-type: none"> <li>– Water supply not connected.</li> <li>– Water supply is shut off.</li> <li>– Water supply to unit blocked or obstructed</li> <li>– Faulty or miswired pressure switch</li> </ul>
<b>E106</b>	Boiler Drain Pump Fault	Hall effect or rotational sensor is not sending a signal to the relay board	<ul style="list-style-type: none"> <li>– Drain pump motor not running or defective.</li> <li>– Hall effect sensor broken or incorrectly wired.</li> <li>– Motor improperly wired.</li> </ul>
<b>E108</b>	Cooling Fan Failure	If the temperature on the control board (relay board) is greater than 140°F (60°C) and less than 176°F (80°C). (See error code E02)	<ul style="list-style-type: none"> <li>– Cooling fan damaged.</li> <li>– Cooling fan blocked or blades have been kept from rotating.</li> <li>– Incoming air temperature exceeds 100°F (38°C).</li> <li>– Air inlet has become blocked.</li> </ul>
<b>E109</b>	High Limit Switch  NOTE: Any oven experiencing this error should be investigated by an authorized Alto-Shaam service provider.	The High Limit Switch input to the CB (N7) is “open”	<ul style="list-style-type: none"> <li>– Unit has experienced an over heat condition.</li> <li>– Convection element contactors stuck closed.</li> <li>– Failed Y1 solenoid.</li> <li>– Obstruction between Y1 solenoid and injection pipe.</li> <li>– Improperly connected drain.</li> <li>– Condensate pan clean out not closed.</li> <li>– Improperly wired high limit switch at the switch or at the CB.</li> <li>– Defective high limit switch.</li> </ul>

CONTINUED ON NEXT PAGE

## Error Codes

Error Code	Error Call Out in Display	Description of Error	Possible Cause(s)
<b>E200</b>	The SD card has been detected to be larger than 2GB in size.	The SD card inserted is larger than 2GB in size.	— SD card is larger than 2GB in size. Contact service to order replacement SD card.
<b>E210</b>	VFD Under Voltage	VFD has detected an under-voltage situation.	— Possible VFD failure.
<b>E211</b>	VFD Over Voltage	VFD has detected an over-voltage situation.	— Possible VFD failure.
<b>E212</b>	VFD Overheating	VFD has detected an overheat situation.	— Unit has experienced an over heat condition. — Defective high limit switch. — Defective cooling fans. — Possible VFD failure.
<b>E213</b>	Motor Over Current	Motor over current detected.	— Blocked fan wheel. — Possible VFD failure.
<b>E214</b>	VFD Current Peak	VFD current peak detected.	— Possible VFD failure.
<b>E215</b>	VFD EEPROM Error	VFD EEPROM error detected.	— Possible VFD failure.
<b>E216</b>	VFD Over Current	VFD over current detected.	— Possible VFD failure.
<b>E217</b>	VFD Short Circuit	VFD Short Circuit detected.	— Possible VFD failure.
<b>E218</b>	VFD Voltage Error	VFD voltage does not correspond to jumper settings.	— VFD voltage jumper is not correct. — Possible VFD failure.
<b>E220</b>	Lower VFD Under Voltage	Lower VFD has detected an under-voltage situation.	— Possible Lower VFD failure.
<b>E221</b>	Lower VFD Over Voltage	Lower VFD has detected an over-voltage situation.	— Possible Lower VFD failure.
<b>E222</b>	Lower VFD Overheating	Lower VFD has detected an overheat situation.	— Unit has experienced an over heat condition. — Defective high limit switch. — Defective cooling fans. — Possible Lower VFD failure.
<b>E223</b>	Lower Motor Over Current	Lower Motor over current detected.	— Possible Lower VFD failure.
<b>E224</b>	Lower VFD Current Peak	Lower VFD current peak detected.	— Possible Lower VFD failure.
<b>E225</b>	Lower VFD EEPROM Error	Lower VFD EEPROM Error detected.	— Possible Lower VFD failure.
<b>E226</b>	Lower VFD Over Current	Lower VFD over current detected.	— Possible Lower VFD failure.
<b>E227</b>	Lower VFD Short Circuit	Lower VFD short circuit detected.	— Possible Lower VFD failure.
<b>E228</b>	Lower VFD Voltage Error	Lower VFD voltage does not correspond to jumper settings.	— Lower VFD voltage jumper is not correct. — Possible Lower VFD failure.
<b>E289</b>	Unknown Error from VFD	VFD has provided an unknown error.	— Possible VFD failure.
<b>E290</b>	Unknown Error from Lower VFD	Lower VFD has provided an unknown error.	— Possible Lower VFD failure.



### Touch Motor Control Error Codes

The LED is located on the variable frequency drive (VFD) ① of the oven.

Type of Error	Indication	Release of Error
<b>Undervoltage</b>	LED flashing sequence, with 1 flash per period.	Voltage of intermediate circuit is less than 250V
<b>Overvoltage</b>	LED flashing sequence, with 2 flashes per period.	Voltage of intermediate circuit exceeds 445V
<b>Excess Temperature</b>	LED flashing sequence, with 3 flashes per period.	Temperature sensor in the power unit is more than 199°F (93°C)
<b>Current Peak</b>	LED flashing sequence, with 4 flashes per period.	Blocked motor, detected by current peak monitoring from 900 rpm rotating field
<b>Overcurrent</b>	LED flashing sequence, with 5 flashes per period.	Intermediate circuit current exceeds 4.0 A
<b>Short-circuit</b>	LED flashing sequence, with 6 flashes per period.	Release of interrupt at intermediate circuit current larger than 53 A
<b>Power on</b>	LED flashing sequence, with 7 flashes per period.	Effective mains voltage does not correspond to jumper setting 115V/230V
<b>Watchdog</b>	LED flashing sequence, with 8 flashes per period.	Watchdog of the microcontroller released, program crash

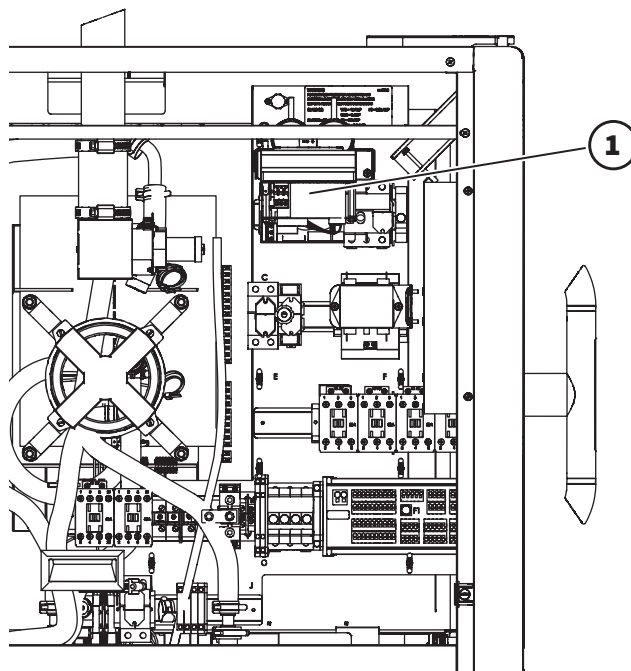



---

<b>Introduction</b>	Alto-Shaam, Inc. warrants to the original purchaser only, that any original part found to be defective in material or workmanship will be replaced with a new or rebuilt part at Alto-Shaam's option, subject to provisions hereinafter stated.
---------------------	---

---

<b>Warranty Period</b>	<p>The original parts warranty period is as follows:</p> <ul style="list-style-type: none"><li>■ For all other original parts, one (1) year from the date of installation of appliance or fifteen (15) months from the shipping date, whichever occurs first.</li><li>■ The labor warranty period is one (1) year from the date of installation or fifteen (15) months from the shipping date, whichever occurs first.</li><li>■ Alto-Shaam will bear normal labor charges performed during standard business hours, excluding overtime, holiday rates or any additional fees.</li><li>■ For the refrigeration compressor, if installed, the warranty period is five (5) years from the date of original installation of the appliance.</li><li>■ For heating elements on Halo Heat® Cook and Hold ovens, the warranty period is for as long as the original owner owns the oven. This warranty period applies to units sold after 2/1/2009 and excludes holding-only ovens.</li><li>■ To be valid, a warranty claim must be asserted during the applicable warranty period. This warranty is not transferable.</li></ul>
------------------------	---

---

<b>Exclusions</b>	<p>This warranty does not apply to:</p> <ul style="list-style-type: none"><li>■ Calibration.</li><li>■ Replacement of light bulbs, rubber gaskets, grease filters, air filters, racks, jet plates, and/ or the replacement of glass due to damage of any kind.</li><li>■ Equipment damage caused by accident, shipping, improper installation or alteration.</li><li>■ Equipment used under conditions of abuse, misuse, carelessness or abnormal conditions, including but not limited to, equipment subjected to harsh or inappropriate chemicals, including but not limited to, compounds containing chloride or quaternary salts, poor water quality, or equipment with missing or altered serial numbers.</li><li>■ Equipment damage caused by use of any cleaning agents other than those recommended by Alto-Shaam, including but not limited to damage due to chlorine or other harmful chemicals.</li><li>■ Any losses or damage resulting from malfunction, including loss of food product, revenue, or consequential or incidental damages of any kind.</li><li>■ Equipment modified in any manner from original model, substitution of parts other than factory authorized parts, unauthorized removal of any parts including legs, or unauthorized addition of any parts.</li><li>■ Equipment damage incurred as a direct result of poor water quality*, inadequate maintenance of steam generators and/or surfaces affected by water. Water quality and required maintenance of steam generating equipment is the responsibility of the owner/ operator.</li><li>■ Equipment damage incurred as a result of not following the required maintenance schedule published in the manuals for the equipment.</li></ul>
-------------------	---

---

<b>Conclusion</b>	<p>This warranty is exclusive and is in lieu of all other warranties, express or implied, including the implied warranties of merchantability and fitness for a particular purpose. No person except an officer of Alto-Shaam, Inc. is authorized to modify this warranty or to incur on behalf of Alto-Shaam any other obligation or liability in connection with Alto-Shaam equipment.</p>
-------------------	--

*\*Refer to the product spec sheet for water quality standards.*



**Alto-Shaam World Headquarters**

W164 N9221 Water Street, PO Box 450  
 Menomonee Falls, WI 53052-0450, U.S.A.  
 Phone 800-558-8744; +1-262-251-3800

**Alto-Shaam Asia**

Shanghai, China  
 Phone +86-21-6173 0336

**Alto-Shaam Central & South America**

Miami, FL USA  
 Phone +1-954-655-5727

**Alto-Shaam France, L.L.C.**

Aix en Provence, France  
 Phone +33(0)4-88-78-21-73

**Alto-Shaam Mexico**

Leon, Mexico  
 Phone +52 1 477-754-1305

**Alto-Shaam Canada**

Concord, Ontario Canada  
 Toll Free Phone 866-577-4484  
 Phone +1-905-660-6781

**Alto-Shaam Middle East & Africa**

Dubai, UAE  
 Phone +971 4 321 9712

**Alto-Shaam GmbH**

Bochum, Germany  
 Phone +49(0)234-298798-0

**Alto-Shaam Russia**

Moscow, Russia  
 Phone +7-903-793-2331