

Scotsman®

SERVICE MANUAL

MXG 328

MXG 428

MXG 438

MXG 638

MXG 938

**Electronic
modular cubers**

Scotsman Ice Srl
Via Lainate, 31 - 20010 Pogliano M.se - Milano - Italy
Tel. +39-02-93960.1 (Aut. Sel.)- Telefax +39-02-93550500
Direct Line to Service & Parts:
Phone +39-02-93960350 - Fax +39-02-93540449
Website: www.scotsman-ice.it
E-Mail: scotsman.europe@scotsman.it



REV. 06/2017

TABLE OF CONTENTS	Table of contents	2
	Specifications MXG 328	3
	Specifications MXG 428	5
	Specifications MXG 438	7
	Specifications MXG 638	9
	Specifications MXG 938	11
	GENERAL INFORMATION AND INSTALLATION	
	Introduction	13
	Unpacking and Inspection - Ice maker	13
	Unpacking and Inspection - Storage bin	13
	Location and levelling	13
	Electrical connections	14
	Water supply and drain connections	14
	Final check list	15
	Installation practice	15
	OPERATING INSTRUCTIONS	
	Start up	16
	Operatiobnal checks	17
	OPERATING PRINCIPLES (How it works)	
	Freezing cycle	21
	Harvest cycle	23
	Control sequence	24
	Component description	25
	ADJUSTMENT, REMOVAL AND REPLACEMENT PROCEDURES	
	Adjustment of the cube size	30
	Wiring diagram	31÷34
	Service diagnosis	35
	MAINTENANCE AND CLEANING INSTRUCTIONS	
	General	37
	Icemaker	37
	Cleaning instructions of water system	38

SPECIFICATIONS

ELECTRONIC CUBER MODEL MXG 328

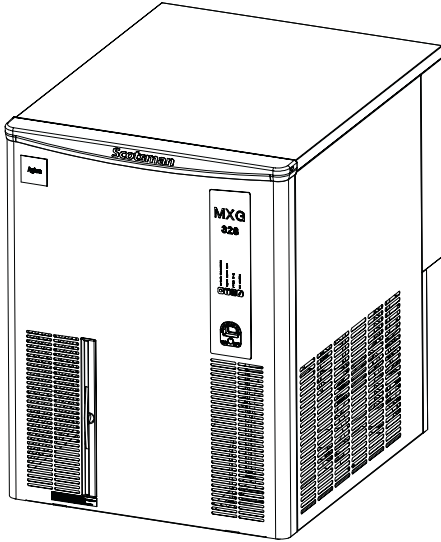

Important operating requirements:

	MIN.	MAX.
Air temperature	10°C (50°F)	40°C (100°F)
Water temperature	5°C (40°C)	35°C (90°F)
Water pressure	1 bar (14 psi)	5 bars (70 psi)
Electr. voltage variations from voltage rating specified on nameplate	-10%	+10%

ice making capacity

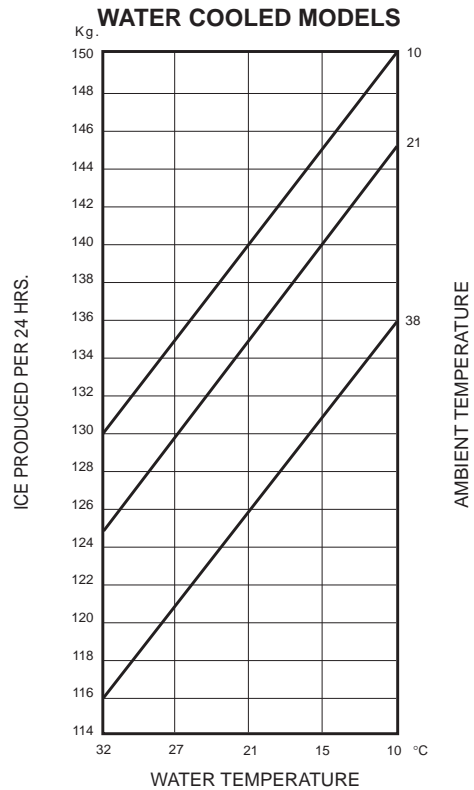
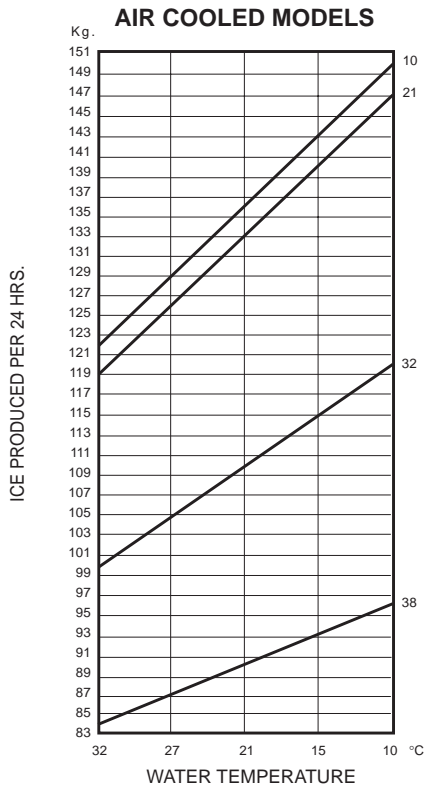

NOTE. The daily ice-making capacity is directly related to the condenser air inlet temperature, water temperature and age of the machine.

To keep your **SCOTSMAN MODULAR CUBER** at peak performance levels, periodic maintenance checks must be carried out as indicated on maintenance section of this manual.

Production charts shown are indicating the production of "M" (medium) and "L" (large) models. For "S" (small) models ice production is approx. 10% lower.

SPECIFICATIONS

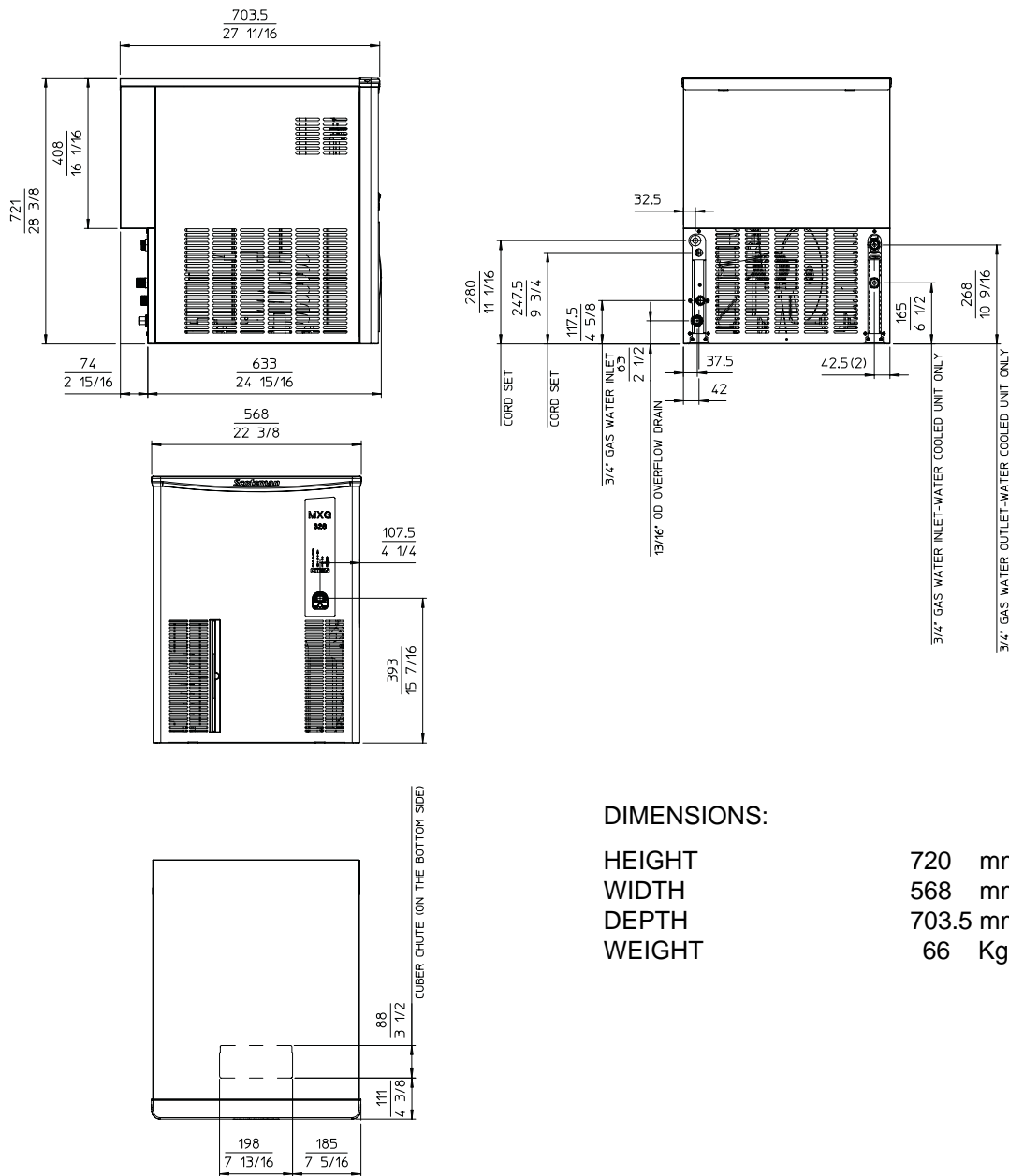

DIMENSIONS:

HEIGHT 720 mm.
 WIDTH 568 mm.
 DEPTH 703.5 mm.
 WEIGHT 66 Kgs.

MXG 328 - MACHINE SPECIFICATIONS

Model	Cond. unit	Finish	Water req. - lt/24 HR			
MXG 328 AS 6 MXG 328 WS 6	Air Water	Stainless steel Stainless steel	320 1250*			
Basic electr.	Amps	Starts amps.	Watts	Electric power cons. Kwh x 24 HR	N. of wires	Amps. fuse
230/50/1	5.5	31	1200	23.3	3 x 1.5 mm ²	16

Cubes per harvest: 72 Large - 106 Medium - 198 Small
 * At 15°C (60°F) water temperature

SPECIFICATIONS

ELECTRONIC CUBER MODEL MXG 428

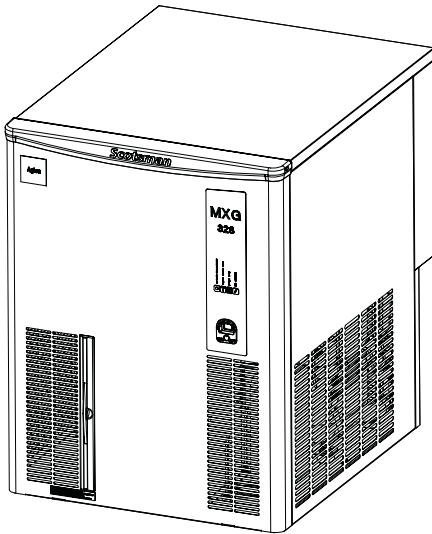

Important operating requirements:

	MIN.	MAX.
Air temperature	10°C (50°F)	40°C (100°F)
Water temperature	5°C (40°C)	35°C (90°F)
Water pressure	1 bar (14 psi)	5 bars (70 psi)
Electr. voltage variations from voltage rating specified on nameplate	-10%	+10%

ice making capacity

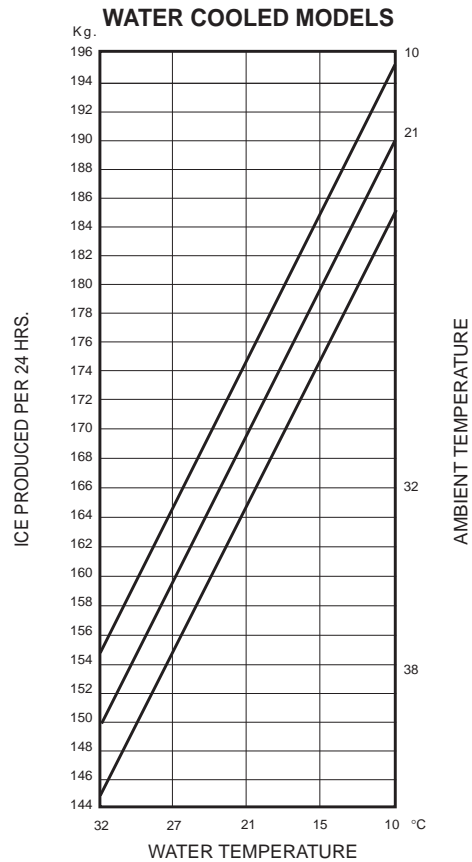
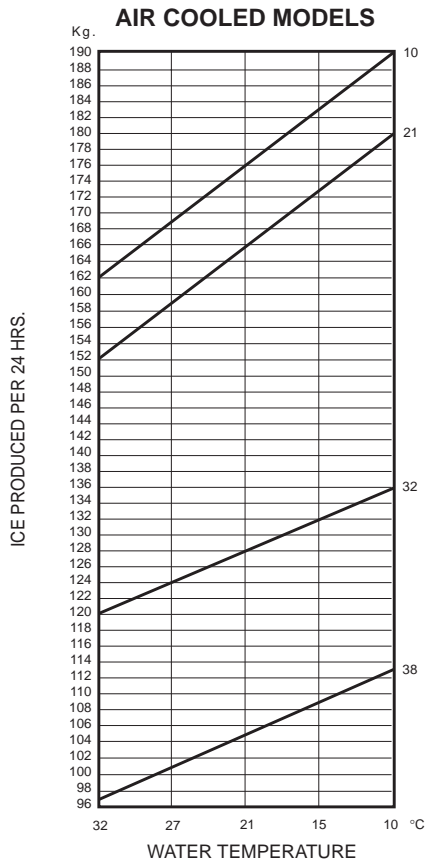

NOTE. The daily ice-making capacity is directly related to the condenser air inlet temperature, water temperature and age of the machine.

To keep your **SCOTSMAN MODULAR CUBER** at peak performance levels, periodic maintenance checks must be carried out as indicated on maintenance section of this manual.

Production charts shown are indicating the production of "M" (medium) and "L" (large) models. For "S" (small) models ice production is approx. 10% lower.

SPECIFICATIONS

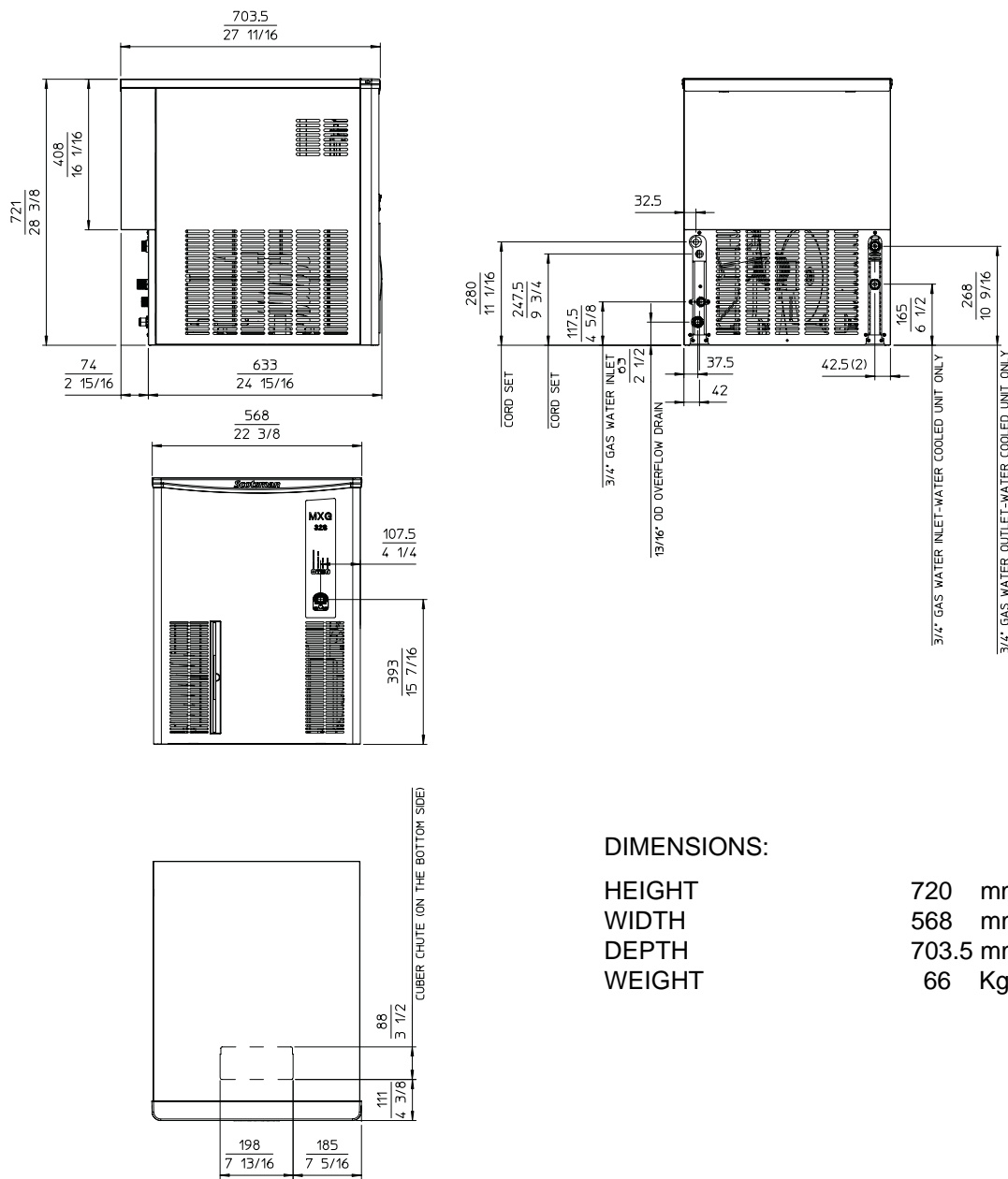

DIMENSIONS:

HEIGHT 720 mm.
 WIDTH 568 mm.
 DEPTH 703.5 mm.
 WEIGHT 66 Kgs.

MXG 428 - MACHINE SPECIFICATIONS

Model	Cond. unit	Finish	Water req. - lt/24 HR
MXG 428 AS 6 MXG 428 WS 6	Air Water	Stainless steel Stainless steel	370

Basic electr.	Amps	Starts amps.	Watts	Electric power cons. Kwh x 24 HR	N. of wires	Amps. fuse
230/50/1 400/50/3	9.9	31	1850	36.7	3 x 1.5 m/m ² 5 x 1.5 m/m ²	16

Cubes per harvest: 72 Large - 106 Medium - 198 Small
 * At 15°C (60°F) water temperature

SPECIFICATIONS

ELECTRONIC CUBER MODEL MXG 438

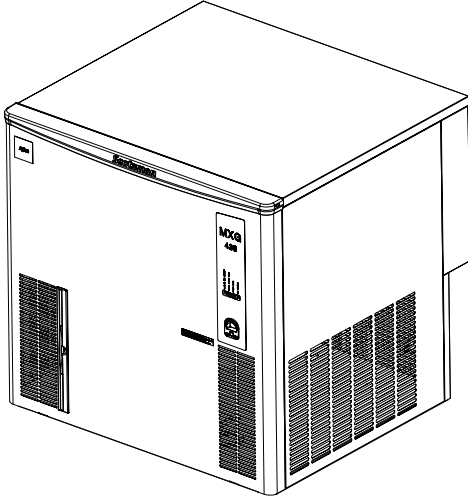

Important operating requirements:

	MIN.	MAX.
Air temperature	10°C (50°F)	40°C (100°F)
Water temperature	5°C (40°C)	35°C (90°F)
Water pressure	1 bar (14 psi)	5 bars (70 psi)
Electr. voltage variations from voltage rating specified on nameplate	-10%	+10%

ice making capacity

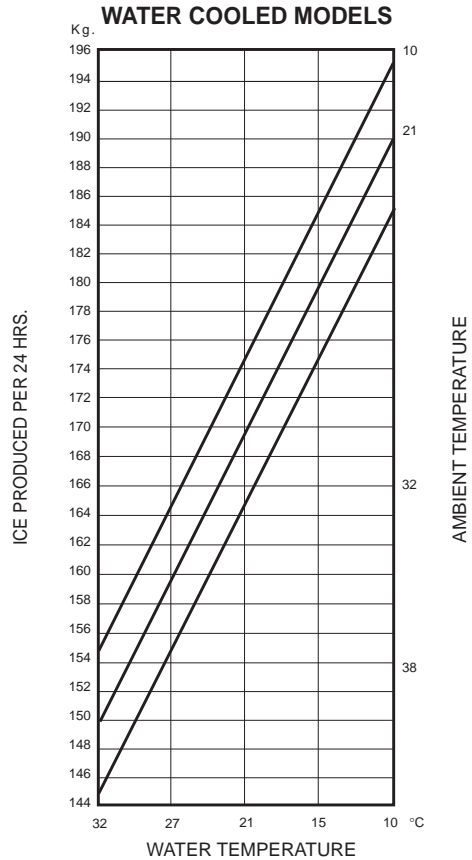
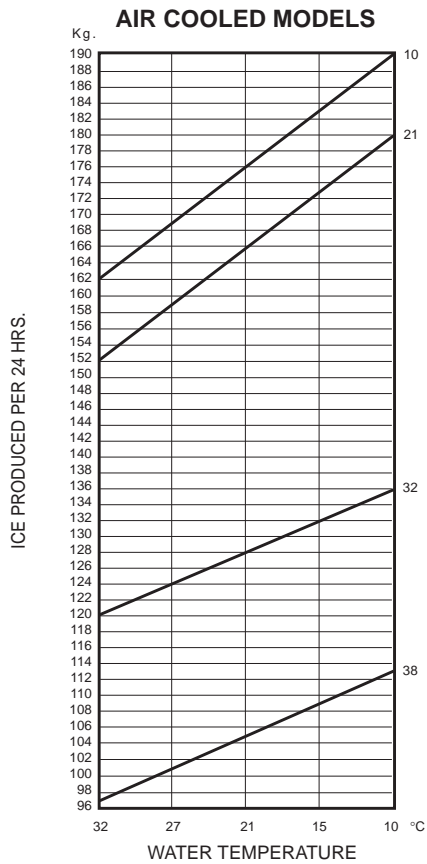

NOTE. The daily ice-making capacity is directly related to the condenser air inlet temperature, water temperature and age of the machine.
 To keep your **SCOTSMAN MODULAR CUBER** at peak performance levels, periodic maintenance checks must be carried out as indicated on maintenance section of this manual.
 Production charts shown are indicating the production of "M" (medium) and "L" (large) models. For "S" (small) models ice production is approx. 10% lower.

SPECIFICATIONS

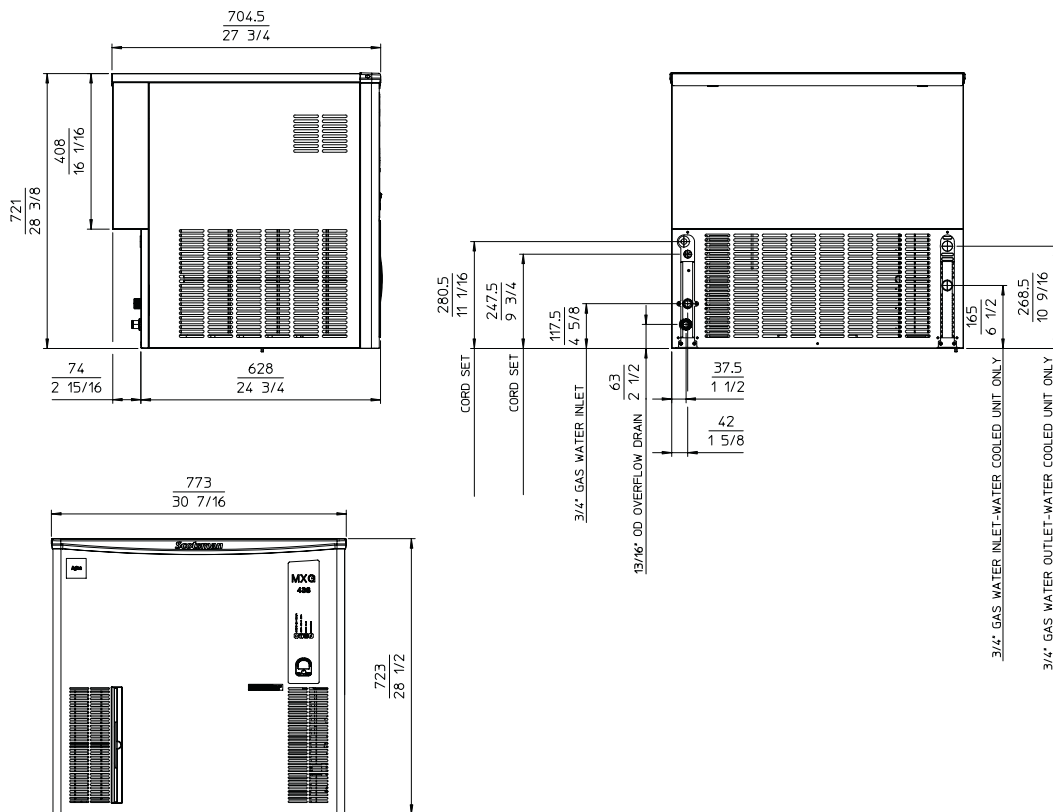

DIMENSIONS:

HEIGHT 720 mm.
 WIDTH 773 mm.
 DEPTH 704.5 mm.
 WEIGHT 73 Kgs.

MXG 438 - MACHINE SPECIFICATIONS

Model		Cond. unit		Finish		Water req. - lt/24 HR	
MXG 438 AS 6		Air		Stainless steel		370	
MXG 438 WS 6		Water		Stainless steel			
Basic electr.	Amps	Starts amps.	Watts	Electric power cons. Kwh x 24 HR	N. of wires	Amps. fuse	
230/50/1 400/50/3	9.9	31	1850	36.7	3 x 1.5 m/m ² 5 x 1.5 m/m ²	16	

Cubes per harvest: 72 Large - 106 Medium - 198 Small
 * At 15°C (60°F) water temperature

SPECIFICATIONS

ELECTRONIC CUBER MODEL MXG 638

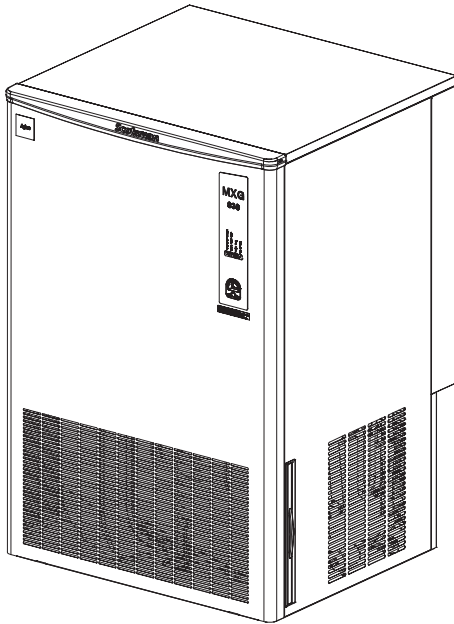

Important operating requirements:

	MIN.	MAX.
Air temperature	10°C (50°F)	40°C (100°F)
Water temperature	5°C (40°C)	35°C (90°F)
Water pressure	1 bar (14 psi)	5 bars (70 psi)
Electr. voltage variations from voltage rating specified on nameplate	-10%	+10%

ice making capacity

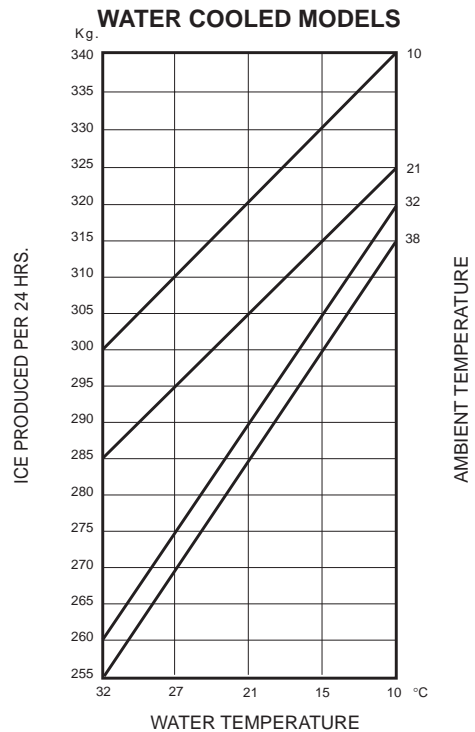
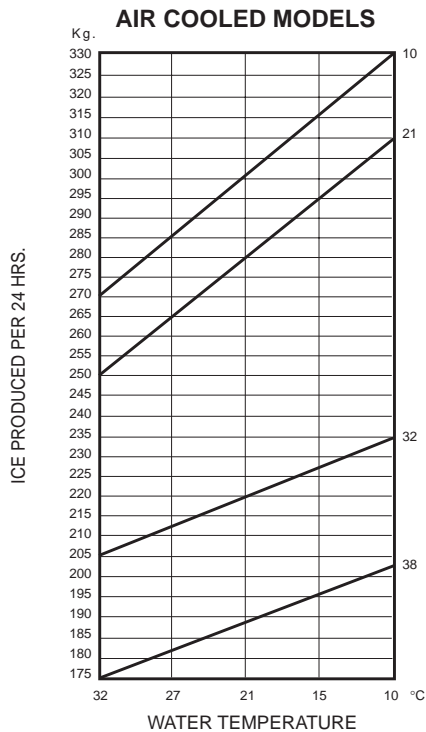

NOTE. The daily ice-making capacity is directly related to the condenser air inlet temperature, water temperature and age of the machine.

To keep your **SCOTSMAN MODULAR CUBER** at peak performance levels, periodic maintenance checks must be carried out as indicated on maintenance section of this manual.

Production charts shown are indicating the production of "M" (medium) and "L" (large) models. For "S" (small) models ice production is approx. 10% lower.

SPECIFICATIONS

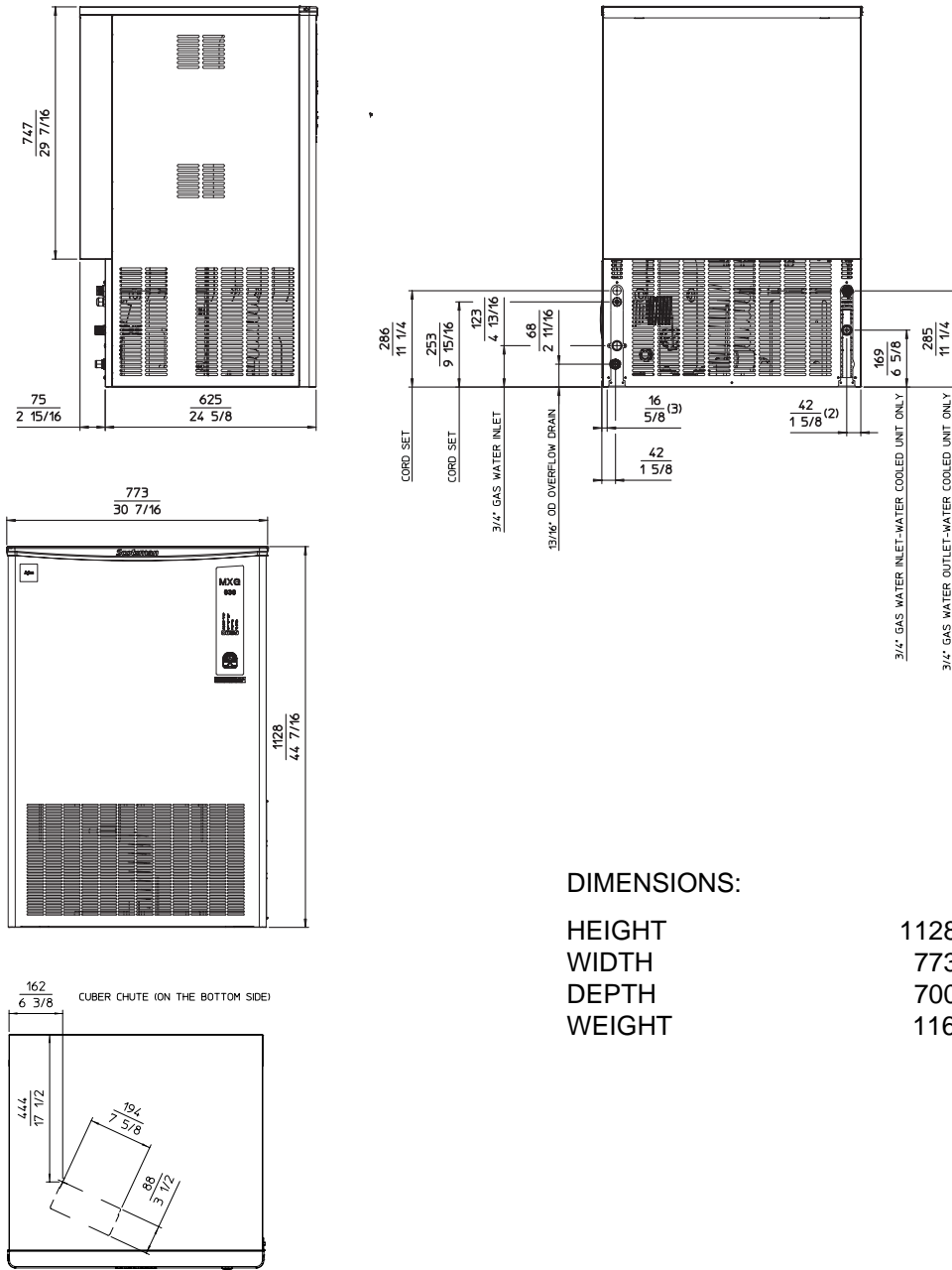

DIMENSIONS:

HEIGHT 1128 mm.
 WIDTH 773 mm.
 DEPTH 700 mm.
 WEIGHT 116 Kgs.

MXG 638 - MACHINE SPECIFICATIONS

Model	Cond. unit	Finish	Water req. - lt/24 HR
MXG 638 AS 6	Air	Stainless steel	550
MXG 638 WS 6	Water	Stainless steel	3400

Basic electr.	Amps	Starts amps.	Watts	Electric power cons. Kwh x 24 HR	N. of wires	Amps. fuse
230/50/1	14.1	66	2500	52	3 x 1.5 m/m ²	20
400/50/3	5.3	26.5	2800		5 x 1.5 m/m ²	

Cubes per harvest: 144 Large - 212 Medium - 396 Small
 * At 15°C (60°F) water temperature

SPECIFICATIONS

ELECTRONIC CUBER MODEL MXG 938

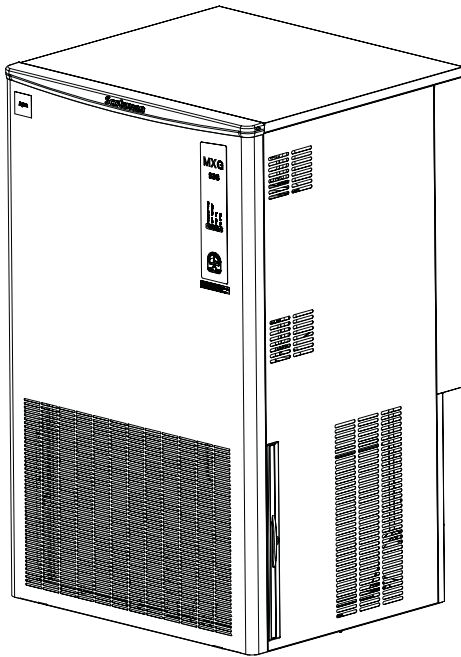

Important operating requirements:

	MIN.	MAX.
Air temperature	10°C (50°F)	40°C (100°F)
Water temperature	5°C (40°C)	35°C (90°F)
Water pressure	1 bar (14 psi)	5 bars (70 psi)
Electr. voltage variations from voltage rating specified on nameplate	-10%	+10%

ice making capacity

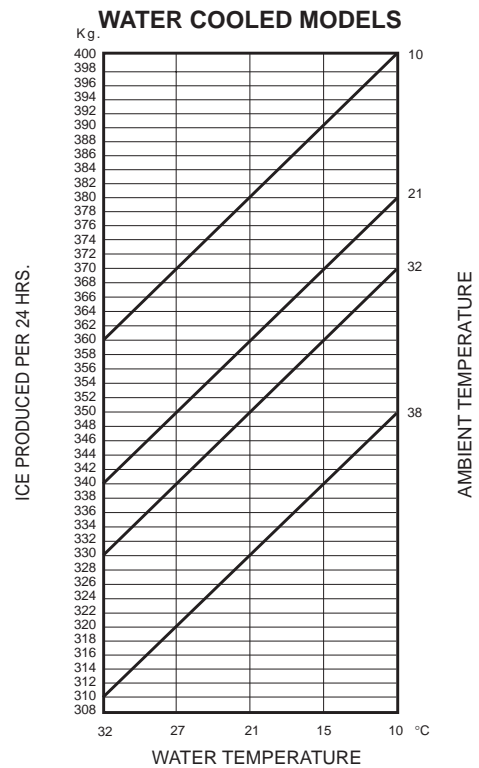
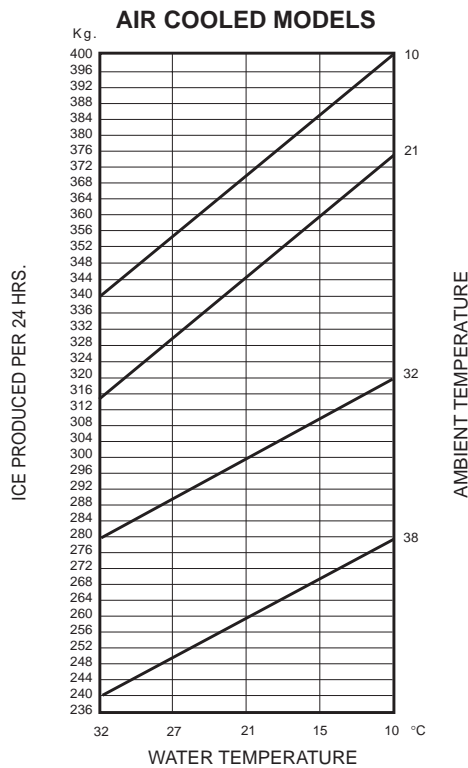

NOTE. The daily ice-making capacity is directly related to the condenser air inlet temperature, water temperature and age of the machine.

To keep your **SCOTSMAN MODULAR CUBER** at peak performance levels, periodic maintenance checks must be carried out as indicated on maintenance section of this manual.

Production charts shown are indicating the production of "M" (medium) and "L" (large) models. For "S" (small) models ice production is approx. 10% lower.

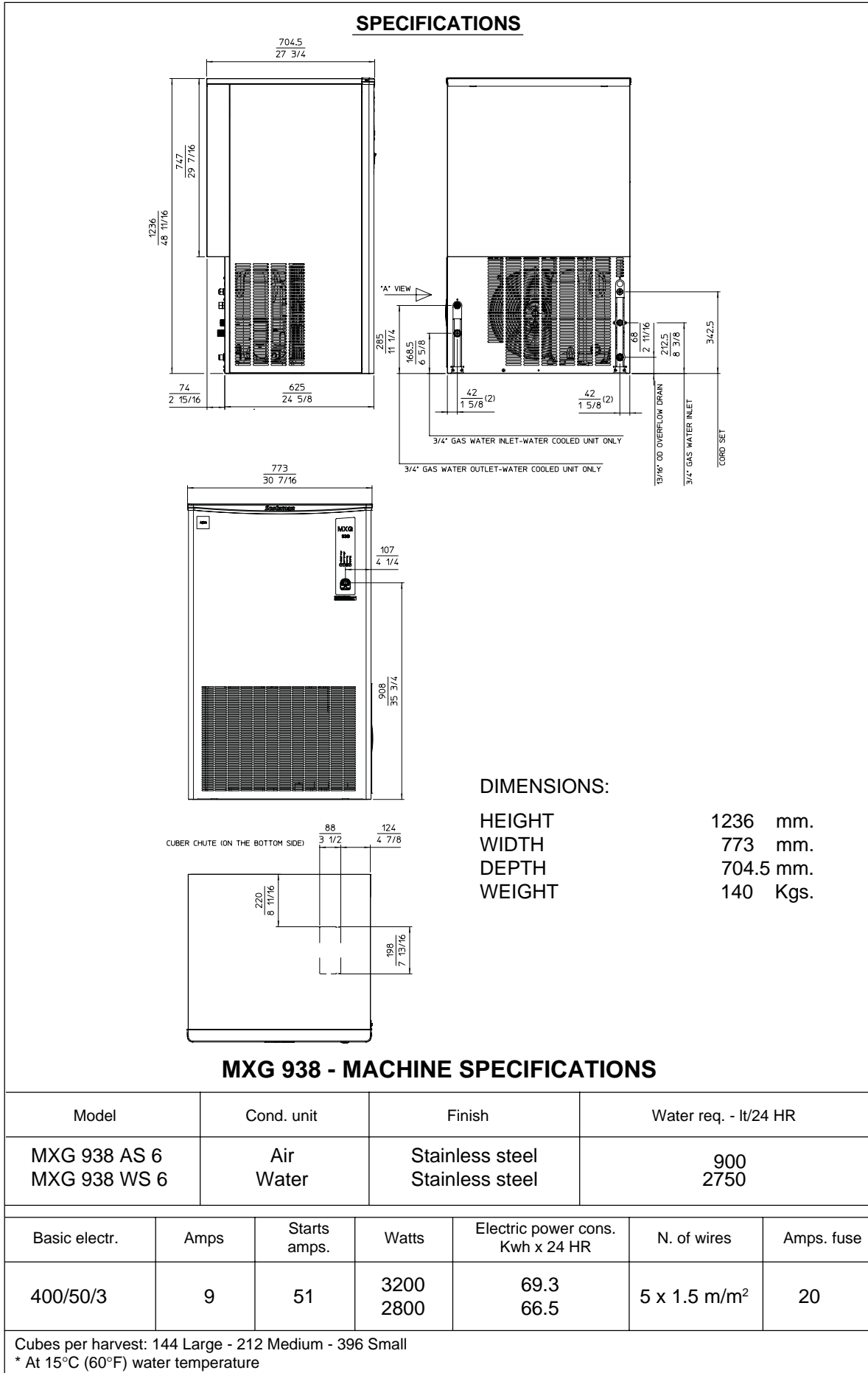

GENERAL INFORMATION AND INSTALLATION

A. INTRODUCTION

This manual provides the specifications and the step-by-step procedures for the installation, start-up and operation, maintenance and cleaning for the **SCOTSMAN MODULAR CUBERS**.

The Electronic Modular Cubers are quality designed, engineered and manufactured.

Their ice making systems are thoroughly tested providing the utmost in flexibility to fit the needs of a particular user.

These icemakers have been engineered to our own rigid safety and performance standards.

NOTE. *To retain the safety and performance built into this icemaker, it is important that installation and maintenance be conducted in the manner outlined in this manual.*

Storage Bin

Since the MXG series Modular Cubers do not have their own attached ice storage bins, it is necessary to use an auxiliary bin such as:

SB 193
SB 322
SB 393
SB 530.

B. UNPACKING AND INSPECTION

Modular Cuber

1. Call your authorized SCOTSMAN Distributor or Dealer for proper installation.

2. Visually inspect the exterior of the packing and skid. Any severe damage noted should be reported to the delivering carrier and a concealed damage claim form filled in subject to inspection of the contents with the carrier's representative present.

3. a) Cut and remove the plastic strip securing the carton box to the skid.

b) Remove the packing nails securing the carton box to the skid.

c) Cut open the top of the carton and remove the polystyrene protection sheet.

d) Pull out the polystyrene posts from the corners and then remove the carton.

4. Remove top and sides panels of the unit and inspect for any concealed damage. Notify carrier of your claim for the concealed damage as stated in step 2 above.

5. Loose two nuts on left and right side of the unit base and remove it from the skid. Save the two bolts and nuts to mount the machine on storage bin or on top of another Modular Cuber.

6. Remove all internal support packing and masking tape and the hardware package.

7. Check that refrigerant lines do not rub against or touch other lines or surfaces, and that the fan blade moves freely.

8. Check that the compressor fits snugly onto all its mounting pads.

9. See data plate on the rear side of the unit and check that local main voltage corresponds with the voltage specified on it.

CAUTION. **Incorrect voltage supplied to the icemaker will void your parts replacement program.**

10. Remove the manufacturer's registration card from the inside of the User Manual and fill-in all parts including: Model and Serial Number taken from the data plate.

Forward the completed self-addressed registration card to Scotsman Ice srl.

C. LOCATION AND LEVELLING

WARNING. **This Ice Cuber is designed for indoor installation only. Extended periods of operation at temperature exceeding the following limitations will constitute misuse under the terms of the SCOTSMAN Manufacturer's Limited Warranty resulting in LOSS of warranty coverage.**

1. Position the Bin in the selected permanent location. Criteria for selection of location include:

a) Minimum room temperature 10°C (50°F) and maximum room temperature 40°C (100°F).

b) Water inlet temperatures: minimum 5°C (40°F) and maximum 35°C (90°F).

c) Well ventilated location for air cooled models.

d) Service access: adequate space must be left for all service connections through the rear of the ice maker. A minimum clearance of 15 cm (6") must be left at the sides of the unit for routing cooling air drawn into and exhausted out of the compartment to maintain proper condensing operation of air cooled models.

2. Level the Storage Bin Assy in both the left to right and front to rear directions by means of the adjustable legs.

3. Inspect the Storage Bin top mounting gasket which should be flat with no wrinkles, to provide a good sealing when the Modular Cuber is installed on top of it.
4. Place the Modular Cuber on top of Storage bin using care not to wrinkle or tear the gasket.
5. Lift a little bit the Modular Cuber right side in order to be able to mount the ice level control bracket taking care to align the hole located on unit base to mate with the one on the top of the Bin.
6. Remove the PVC plastic plug closing the round hole located on the side of the ice chute opening.
7. Trace the ice level control assy, secured for the transport of the Modular Cuber, and direct it down through the round hole into the Storage Bin.
8. Fasten the ice level control assy on its bracket by means of the two screws found in the hardware package supplied with the unit.
9. Make a cut (shear) in the PVC plastic plug that goes from its edge to the center; insert the ice level control cable in the center of the plastic plug so to prevent it from any sort of contact with the unit frame, then place again the PVC plug in the round hole keeping the cable exceeding portion inside the unit.
10. Install the plastic ice cube deflector by hooking it on the flange of the ice chute opening in unit base (see illustration).
11. Secure the Modular Cuber on the top of the Storage Bin using the two bolts and diber washer found in the hardware package supplied with the unit.

D. ELECTRICAL CONNECTIONS

See data plate for current requirements to determine wire size to be used for electrical connections. All SCOTSMAN icemakers require a solid earth wire.

All SCOTSMAN ice machines are supplied from the factory completely pre-wired and require only electrical power connections to the wire cord provided at the rear of the unit.

Make sure that the ice machine is connected to its own circuit and individually fused (see data plate for fuse size).

The maximum allowable voltage variation should not exceed -10% and +10% of the data plate rating. Low voltage can cause faulty functioning and may be responsible for serious damage to the overload switch and motor windings.

NOTE. All external wiring should conform to national, state and local standards and regulations.

Check voltage on the line and the ice maker's data plate before connecting the unit.

E. WATER SUPPLY AND DRAIN CONNECTIONS

General

When choosing the water supply for the ice modular cuber consideration should be given to:

- a) Length of run
- b) Water clarity and purity
- c) Adequate water supply pressure

Since water is the most important single ingredient in producing ice you cannot emphasize too much the three items listed above.

Low water pressure, below 1 bar may cause malfunction of the ice maker unit.

Water containing excessive minerals will tend to produce cloudy coloured ice cubes, plus scale build-up on parts of the water system.

Water supply

Connect the 3/4" GAS male fitting of the solenoid water inlet valve, using flexible tubing or a 3/8" O.D. copper pipe, to the cold water supply line with regular plumbing fitting and a shut-off valve installed in an accessible position between the water supply line and the unit.

Water supply - Water cooled models

The water cooled versions of SCOTSMAN Ice Makers require two separate inlet water supplies, one for the water sprayed for making the ice cubes and the other for the water cooled condenser.

Connect the 3/4" GAS male fitting of the water inlet, using the flexible tubing or a 3/8" O.D. copper pipe, to the cold water supply line with regular plumbing fitting and a shut-off valve installed in an accessible position between the water supply line and the unit.

Water drain

The recommended drain tube is a plastic or flexible tube with 18 mm (3/4") I.D. which runs to an open trapped and vented drain. When the drain is a long run, allow 3 cm pitch per meter (1/4" pitch per foot).

A vent at the unit drain connection is also required for proper sump drainage.

Water drain - Water cooled models

Connect the 3/4" GAS male fitting of the condenser water drain, using a second flexible tubing or a 3/8" O.D. copper tubing, to the open trapped and vented drain.

NOTE. The water supply and the water drain must be installed to conform with the local code. In some case a licensed plumber and/or a plumbing permit is required.

F. FINAL CHECK LIST

1. Is the unit in a room where ambient temperatures are within a minimum of 10°C (50°F) even in winter months?
2. Is there at least a 15 cm (6") clearance around the unit for proper air circulation?
3. Is the unit level? (IMPORTANT)
4. Have all the electrical and plumbing connections been made, and is the water supply shut-off valve open?
5. Has the voltage been tested and checked against the data plate rating?
6. Has the water supply pressure been checked to ensure a water pressure of at least 1 bar (14 psi).
7. Have the bolts holding the compressor down been checked to ensure that the compressor is snugly fitted onto the mounting pads?
8. Check all refrigerant lines and conduit lines to guard against vibrations and possible failure.
9. Have the bin liner and cabinet been wiped clean?
10. Has the owner/user been given the User Manual and been instructed on the importance of periodic maintenance checks?
11. Has the Manufacturer's registration card been filled in properly? Check for correct model and serial number against the serial plate and mail the registration card to the factory.

G. INSTALLATION PRACTICE

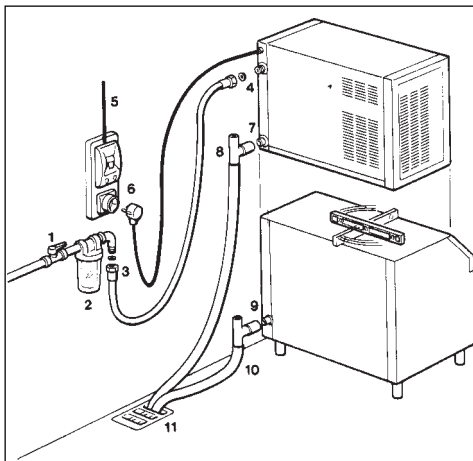

1. Hand shut-off valve
2. Water filter
3. Water supply line (flexible hose)
4. 3/4" gas male fitting
5. Power line
6. Main switch
- 7/9. Drain fitting
- 8/10. Vented drain line
11. Open trapped vented drain

WARNING. This icemaker is not designed for outdoor installation and will not function in ambient temperatures below 10°C (50°F) or above 40°C (100°F).

This icemaker will malfunction with water temperatures below 5°C (40°F) or above 35°C (90°F).

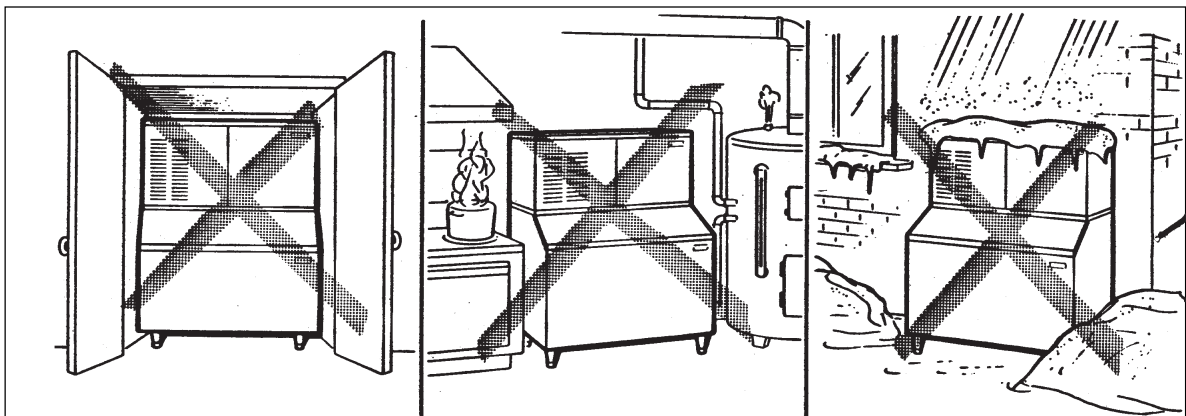

OPERATING INSTRUCTIONS

NOTE. Pcb is equipped by "no delay" (MXG 328-428-438) or 60 minutes **jumper setting start up delay** (see pag. 26). In case of pcb setting to 60 minutes (MXG 638 - 938) ice maker doesn't start until this time is elapsed. After having correctly installed the ice maker and completed the plumbing and electrical connections, perform the following "Start-up" procedure.

START UP

After having correctly installed the ice maker and completed the plumbing and electrical connections, perform the following "Start-up" procedure.

A. Give power to the unit to start it up by switching "ON" the power line main disconnect switch and push "Green button Power" switch at unit front panel.

NOTE. Every time the unit returns under power, after having been switched off, the water inlet valve, the hot gas valve and the water drain valve get energized for a period of 5 minutes, thus to admit new water to the machine sump reservoir to fill it up and, eventually, to wash-off any dirt that can have deposited in it during the unit off period (Fig.1).

B. During the water filling operation, check to see that the incoming water dribbles, through the evaporator platen dribbler holes, down into the sump reservoir to fill it up and also that the incoming surplus of water flows out through the overflow pipe into the drain line. During the water filling phase the components energized are:

THE WATER INLET SOLENOID VALVE
THE HOT GAS SOLENOID VALVE
THE WATER DRAIN SOLENOID VALVE/S
 for the first 30 seconds.

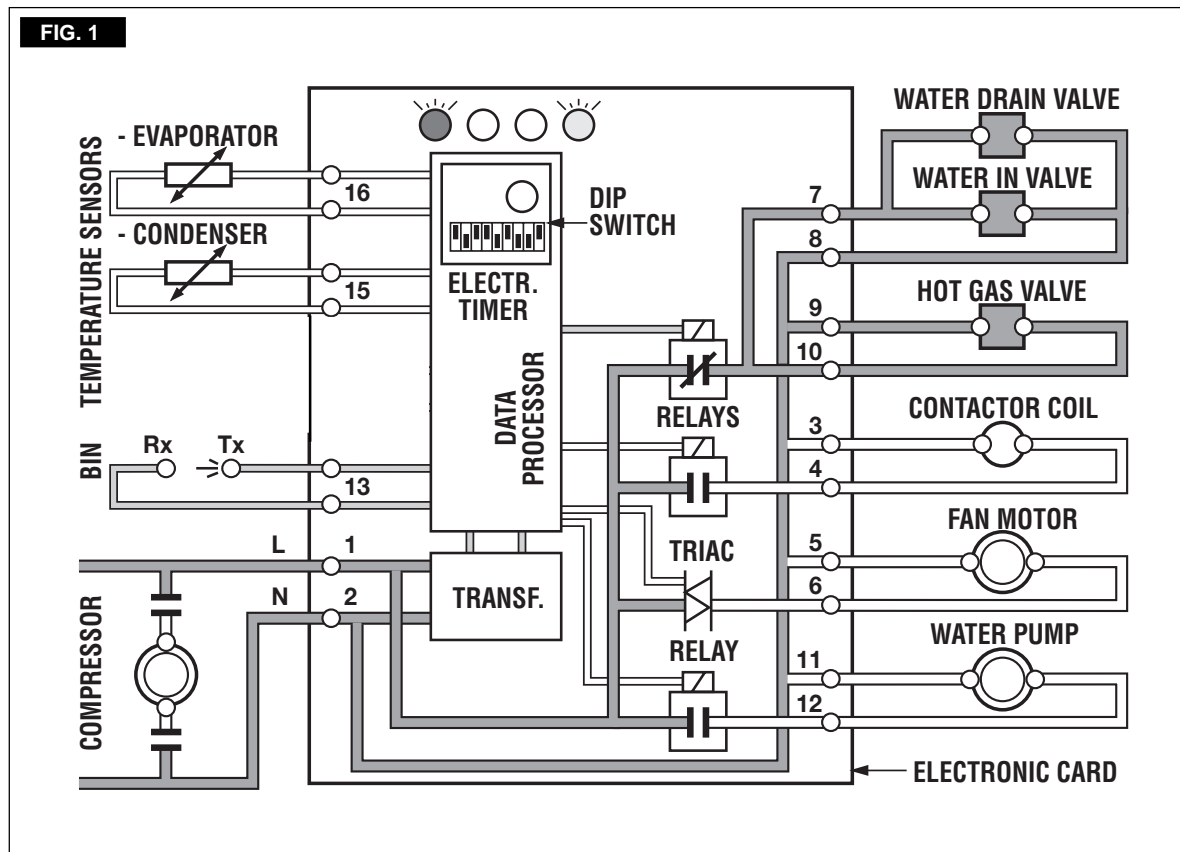

NOTE. If in the 5 minutes length of the water filling phase the machine sump reservoir does not get filled with water up to the rim of the overflow pipe, it is advisable to check:

1. The water pressure of the water supply line that must be at least **1 bar (14 psig)** Minimum (Max 5 bar-70 psig).
2. The filtering device installed in the water line that may reduce the water pressure below the Minimum value of 1 bar (14 psig).
3. Any clogging situation in the water circuit like the inlet water strainer and/or the flow control.

C. At completion of the water filling phase (5 minutes) the unit passes automatically into the freezing cycle with the start up of:

COMPRESSOR

WATER PUMP

FAN MOTOR/S (in air cooled version) controlled by the condensing temperature sensor located within the condenser fins (Fig.2).

OPERATIONAL CHECKS

D. If necessary install the refrigerant service gauges on both the high side and low side Schröder valves to check the compressor head and suction pressures.

NOTE. On air cooled models the condenser temperature sensor, which is located within the condenser fins, keep the head (condensing) pressure at average 21 °C amb/15°C water temp. between 14 and 16 bars (203-232 psig). In the water cooled models the discharge pressure is kept constant at the value of 15 bars (217 psig) by means of a water regulating valve located on the water supply line to the condenser.

In case of condenser clogging such to prevent the proper flow of the cooling air or, in case the fan motor is out of operation or shortage of water in the water cooled condenser, the condenser temperature rises and when it reaches 70°C (160°F) - for air cooled version - or 60°C (140°F) - for water cooled version - the condenser temperature sensor shuts-off the ice maker with the consequent light-up of the RED WARNING LED (Fig.3).



After having diagnosed the reason of the rise of temperature and removed its cause, it is necessary to unplug (wait few seconds) and plug in again the unit, thus to put the machine in condition to initiate a new freezing cycle.

The machine restarts with the usual 5 minutes water filling phase in order to provide enough water into the sump tank.

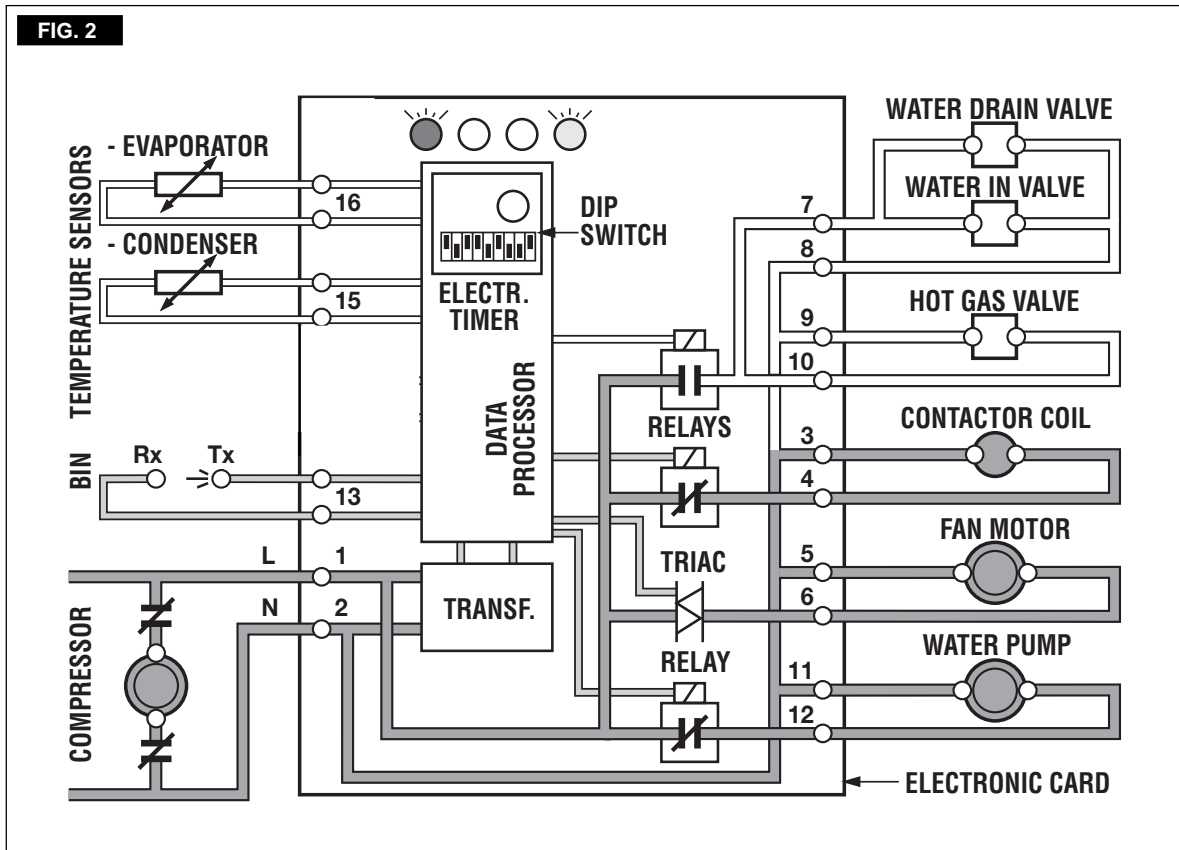

During the freezing process, when the evaporator temperature falls below an established value, to the evaporator temperature sensor supplies a low voltage power signal to the electronic control device (P.C.BOARD) in order to activate an electronic timer.

This one takes over the control of the freezing cycle up to the complete formation of the ice cubes (Fig.4).

NOTE. The length of the entire freezing cycle is governed by the evaporator temperature sensor which has its probe placed in contact with the evaporator serpentine (Non adjustable) in combination with the electronic timer (Adjustable) incorporated in the P.C. BOARD).
The timer adjustment is factory set in consideration of the ice maker model, cooling version and ice cube size (Small, Medium, Large).
It is possible, however, to modify the timed length of the freezing cycle, by changing the **DIP SWITCH** keys setting.
In Table B of PRINCIPLE OF OPERATION are shown the various time extensions of the freezing cycle second phase, in relation with the different DIP SWITCH keys settings.

G. After about 17-20 minutes from the beginning of the freezing cycle, in an hypothetic ambient temperature of 21°C, the defrost cycle takes place with the hot gas and the water inlet valves being simultaneously activated (Fig.5). The electrical components in operation are:

COMPRESSOR

WATER PUMP for the first 30 seconds

WATER INLET SOLENOID VALVE

HOT GAS VALVE

WATER DRAIN SOLENOID VALVE/S

NOTE. The length of the defrost cycle is related to the length of the second phase of freezing cycle T2. (Time to drop the evaporating temperature from 0°C (32°F) - small Red LED blinking-to-15°C (5°F) small Red LED ON steady.
It is possible to extend the length of the defrost cycle by changing the setting of DIP SWITCH 7 and 8 as shown on table at page 28.

H. Check, during the defrost cycle, that the incoming water flows correctly into sump reservoir in order to refill it and that the surplus overflows through the overflow drain tube.

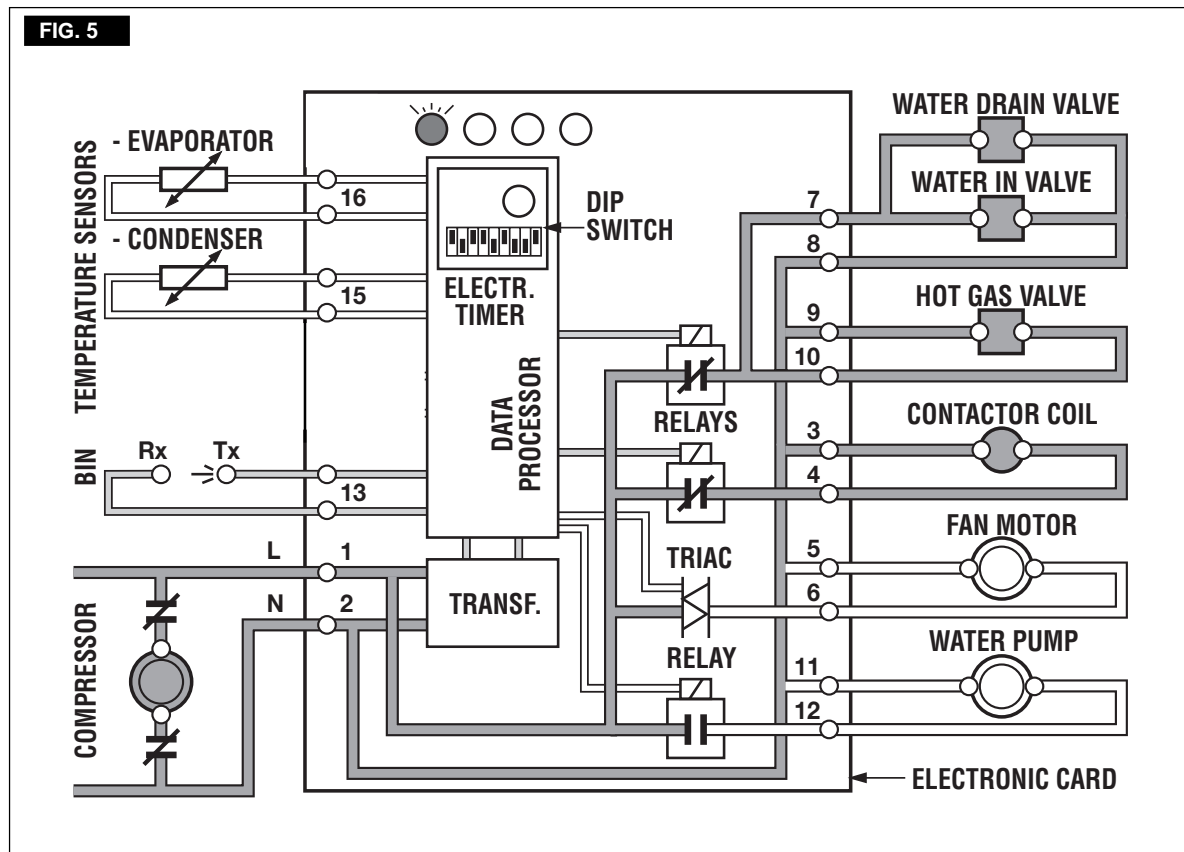

I. Check the texture of ice cubes just released. They have to be in the right shape with a small depression of about 5-6 mm in their crown. If not, wait for the completion of the second cycle before performing any adjustment. If required, the length of the timed freezing cycle can be modified by changing the **DIP SWITCH** keys setting as illustrated in OPERATING PRINCIPLE.

If the ice cubes are shallow and cloudy, it is possible that the ice maker runs short of water during the freezing cycle second phase or, the quality of the supplied water requires the use of an appropriate water filter or conditioner.

J. To be sure of the correct operation of ice level control device, place some ice cubes between its sensing "eyes" to interrupt the light beam. The Bin Full **YELLOW LED** starts blinking fill the end of defrost cycle afterward, the unit stops with the simultaneous glowing of the **same LED** to monitor the **BIN FULL** situation (Fig.6).



Remove ice cubes out from the ice level control sensors to allow the resumption of the light beam. Water inlet valve is energized for 45 seconds to refill the sump, the BIN FULL YELLOW LED blinks fast and after approximately 6 seconds the ice maker resume its operation with the immediate glowing of the **FIRST YELLOW LED** indicating **UNIT IN OPERATION** and the extinguishing of the "BIN FULL" YELLOW LED.

NOTE. The **ICE LEVEL CONTROL (INFRARED SYSTEM)** is independent of the temperature however, the reliability of its detection can be affected by external light radiations or by any sort of dirt and scale sediment which may deposit directly on the light source and on the receiver. To prevent any possible ice maker malfunction, due to negative affection of the light detector, it is advisable to locate the unit where it is **not reached by any direct light beam** or light radiation, also it is recommended to keep the bin door constantly closed and to follow the instructions for the **periodical cleaning of the light sensor elements** as detailed in the MAINTENANCE AND CLEANING PROCEDURES.

At time of installation it's necessary to perform the calibration of the I/R Ice Level control.

- Switch OFF the machine at Master Green Push Button Switch
 - Push and hold the PC Board Push Button
 - Switch ON the machine at Master Green Push Button Switch
 - Few seconds later the LEDs of the PC Board are ON
 - Release the PC Board Push Button
- The I/R Ice Level control is now calibrated.

K. Remove, if previously installed, the refrigerant service gauges and re-fit the unit service panels previously removed.

L. Instruct the owner/user on the general operation of the ice machine and about the cleaning and care it requires.

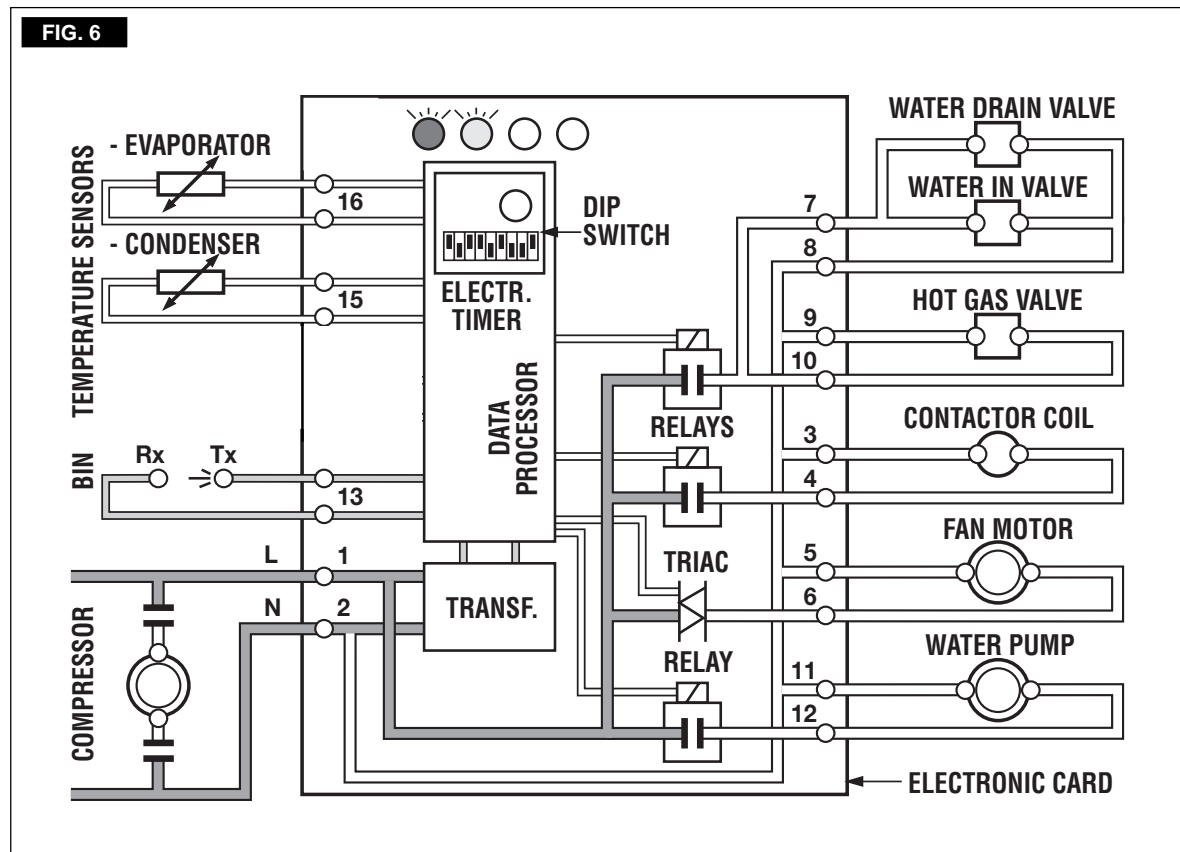

PRINCIPLE OF OPERATION

How it works

In the **SCOTSMAN** Modular Cubers the water used to make the ice is kept constantly in circulation by an electric water pump which primes it to the self propeller spray bar nozzles from where it is diverted into the inverted mold cups of the evaporator (Fig. B).

A small quantity of the sprayed water freezes into ice; the rest of it cascades by gravity into the sump assembly below for recirculation.

FREEZING CYCLE (Fig. A)

The hot gas refrigerant discharged out from the compressor reaches the condenser where, being cooled down, condenses into liquid. Flowing into the liquid line it passes through the drier filter, then it goes all the way through the capillary tube (on MXG 328-428-438-638) and EXP valve on MXG 938 where, due to the heat exchanging action, it loses some of its heat content so that its pressure and temperature are lowered as well.

Next the refrigerant enters into the evaporator serpentine (which has a larger I.D. than the capillary) and starts to boil off; this reaction is emphasized by the heat transferred by the sprayed water. The refrigerant then increases in volume and changes entirely into vapor.

The vapor refrigerant then passes through the suction accumulator (used to prevent that any small amount of liquid refrigerant may reach the compressor) and through the suction line. In both the accumulator and the suction line it exchanges heat with the refrigerant flowing into the capillary tube (warmer), before to be sucked in the compressor and to be recirculated as hot compressed refrigerant gas.

The freezing cycle is controlled by the evaporator temperature sensor (which has its probe in contact with the evaporator serpentine) that determines the length of its first portion of the cycle.

When the temperature of the evaporator serpentine drops to a pre-set value, the evaporator sensor probe changes its electrical resistance allowing a low voltage current (12 volts) to flow to the P.C. BOARD which in turn activates an electronic timer.

The timer, which is built-in the P.C. BOARD, takes over from the evaporator temperature sensor, the control of the freezing cycle up to its completion.

NOTE. *The change of the electric potential of the evaporator sensor with the consequent activation of the timer (Time mode) is signalled by the glowing-up of the RED LED located beside the FREEZING yellow one in the front of the P.C. BOARD.*

TAB. A DIP SWITCH FACTORY SETTING COMBINATIONS PER MODEL AND VERSION										
DIP SWITCH	FREEZING CYCLE				DEFROST CYCLE		DEFR. CYCLE ADD. TIME		15/30°	AIR WATER
	1	2	3	4	5	6	7	8	9	10
MXG-S 328 A	ON	OFF	ON	ON	OFF	ON	ON	ON	OFF	ON
MXG-S 328 W - 230/60	OFF	ON	ON	ON	OFF	ON	ON	ON	OFF	ON
MXG-M 328 A	ON	ON	OFF	ON	OFF	ON	ON	ON	OFF	ON
MXG-M 328 W	ON	ON	OFF	ON	OFF	ON	ON	ON	OFF	OFF
MXG-M 328 W - 230/60	ON	ON	OFF	ON	OFF	ON	OFF	ON	OFF	OFF
MXG-L 328 A	OFF	OFF	OFF	ON	OFF	ON	ON	ON	OFF	ON
MXG-L 328 W	OFF	OFF	OFF	ON	OFF	ON	ON	ON	OFF	OFF
MXG-S 428-438 A	ON	OFF	ON	ON	OFF	ON	ON	ON	OFF	ON
MXG-S 428-438 W										
MXG-M 428-438 A	OFF	OFF	ON	ON	OFF	ON	ON	ON	OFF	ON
MXG-M 428-438 W	OFF	OFF	ON	ON	OFF	ON	ON	ON	OFF	OFF
MXG-M 428-438 - 230/60	ON	ON	OFF	ON	OFF	ON	ON	ON	OFF	ON
MXG-L 428-438 A	OFF	OFF	OFF	ON	OFF	ON	ON	ON	OFF	ON
MXG-L 428-438 W	OFF	OFF	OFF	ON	OFF	ON	ON	ON	OFF	OFF
MXG-S 638 A	ON	OFF	ON	ON	OFF	ON	ON	ON	OFF	ON
MXG-S 638 A - 230/60	ON	OFF	ON	ON	OFF	ON	ON	ON	OFF	ON
MXG-S 638 W										
MXG-M 638 A	ON	ON	OFF	ON	OFF	ON	ON	ON	OFF	ON
MXG-M 638 W	ON	OFF	ON	ON	OFF	ON	ON	ON	OFF	OFF
MXG-M 638 - 230/60	OFF	OFF	ON	ON	OFF	ON	OFF	ON	OFF	ON
MXG-L 638 A	OFF	OFF	OFF	ON	OFF	ON	OFF	ON	OFF	ON
MXG-L 638 A - 400/50/3	OFF	OFF	OFF	ON	OFF	ON	OFF	ON	OFF	ON
MXG-L 638 W	OFF	OFF	OFF	ON	OFF	ON	OFF	ON	OFF	OFF
MXG-L 638 W - 230/60	OFF	OFF	OFF	ON	OFF	ON	OFF	ON	OFF	OFF
MXG-M 938 A	ON	ON	OFF	ON	OFF	ON	ON	ON	OFF	ON
MXG-M 938 W	ON	ON	OFF	ON	OFF	ON	ON	ON	OFF	OFF
MXG-L 938 A	OFF	OFF	OFF	ON	OFF	ON	ON	OFF	OFF	ON
MXG-L 938 W	OFF	OFF	OFF	ON	OFF	ON	ON	OFF	OFF	OFF

FIG. A

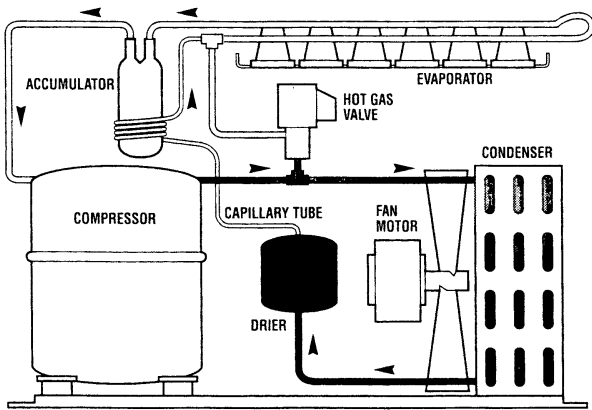

FIG. B

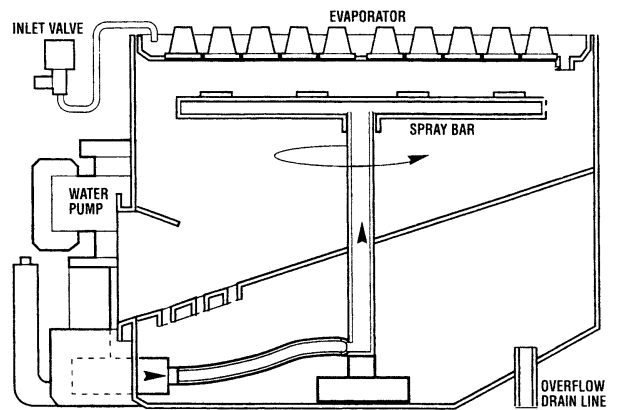

FIG. C

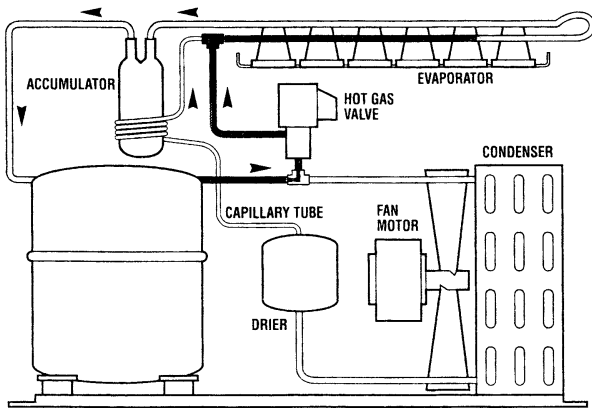
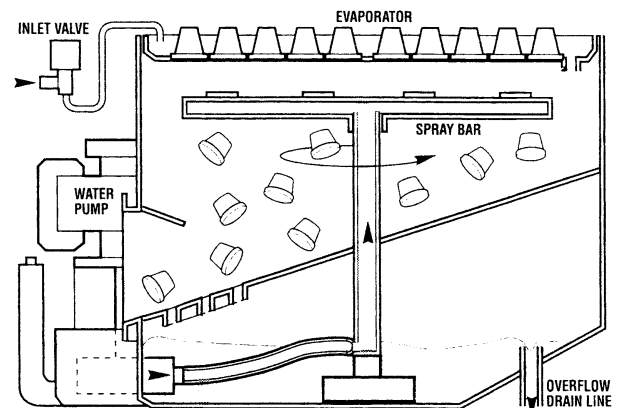

FIG. D



ATTENTION. In case, after 15 minutes from the beginning of the freezing cycle, the temperature of the evaporator sensor probe is higher than 0°C (32°F) (shortage of refrigerant, inoperative hot gas valve, etc.) the P.C. BOARD switch OFF immediately the unit with the simultaneous blinking of the WARNING RED LED.

The length of this second portion of the freezing cycle is pre-fixed and related to the setting of the first four DIP SWITCH keys.

The DIP SWITCH keys setting is made in consideration of the type of condenser used. In Table B are indicated the various lengths of the second portion of freezing cycle (Time mode) in relation to the different combinations of the DIP SWITCH KEYS.

In Table A herebelow are illustrated the DIP SWITCH key combinations for the three different factory.

The electrical components in operation during the freezing cycle are:

COMPRESSOR

FAN MOTOR (in air cooled version)

WATER PUMP

CONTACTOR COIL (only MXG 638-938) and during the second phase of freezing cycle (Time mode) they are joined by the

ELECTRONIC TIMER

At average 21°C amb/15°C water temp. the refrigerant head pressure, in the course of the freezing cycle, ranges between 16 and 14 bars (232-203 psig) being controlled by the temperature sensor probe located within the condenser fins (air cooled version) or, on the condenser tube coil (water cooled version).

On the air cooled version, the condenser temperature sensor, when senses a rising of the condenser temperature beyond the pre-fixed limit, changes its electrical resistance and send a low voltage power flow to the Micro Processor of P.C. BOARD which in turn energizes, through a TRIAC, the FAN MOTOR.

When the opposite situation occurs, i.e. the condenser temperature gets below the pre-fixed limit, the temperature sensor changes again its electrical resistance reducing therefore the current flow to the P.C. BOARD to cause the fan motor temporary cut-off.

NOTE. On this model the condenser sensors are used just to switch off the unit in case the condensing temperature rise up to more than 70°C (for air cooled version) or more than 62°C (for water cooled version) for one of the following abnormal reasons:
CLOGGED CONDENSER (Air cooled version)
FAN MOTOR OUT OF OPERATION (Air cooled version)
INSUFFICIENT FLOW OF COOLING WATER (Water cooled version)
AMBIENT TEMPERATURE HIGHER THEN 40°C (100°F)

it causes the total and immediate SHUT-OFF of the machine in order to prevent the unit from operating in abnormal and dangerous conditions.
When the ice maker stops on account of this protective device, there is a simultaneous glowing of the RED LED, warning the user of the Hi Temperature situation.
After having eliminated the source of the condenser hi-temperature, to restart the machine just switching OFF and ON the unit at main line switch.
The ice machine resumes its normal operation by going through the 5 minutes water filling phase.

MXG refrigerant operating pressures (suction/discharge) may change according to models. See related table at pag. 25.
 The total length of the freezing cycle ranges from 20 to 25 minutes.

DEFROST OR HARVEST CYCLE (Fig. D)

As the electronic timer has carried the system throughout the second phase of freezing cycle, the defrost cycle starts.

ATTENTION. In case the unit be able to reach 0°C (32°F) evaporating temperature within 15 minutes, but after 45 minutes from the beginning of the freezing cycle it has not yet reached the evaporator temperature of -15°C (5°F) the machine goes straight into the defrost cycle omitting the timed portion of the freezing cycle relied to the setting of the first four DIP SWITCHES.

NOTE. The length of the defrost cycle is related to the length of the second phase of freezing cycle T2. (Time to drop the evaporating temperature from 0°C (32°F) - small Red LED blinking-to-15°C (5°F) small Red LED ON steady.
 It is possible to extend the length of the defrost cycle by changing the setting of DIP SWITCH 7 and 8 as shown on table at page 28.

The electrical components in operation during this phase are:

COMPRESSOR

CONTACTOR COIL (only MXG 638)

WATER INLET VALVE

HOT GAS VALVE

WATER DRAIN VALVE

and the

WATER PUMP

on the first 30 seconds.

The incoming water, passing through the water inlet valve and the flow control, runs over the evaporator platen and then flows by gravity through the dribbler holes down into the sump/reservoir (Fig. D).

The water filling the sump/reservoir forces part of the surplus water from the previous freezing cycle to go out to the waste through the overflow pipe. This overflow limits the level of the sump water which will be used to produce the next batch of ice cubes.

Meanwhile, the refrigerant as hot gas, discharged from the compressor, flows through the hot gas valve directly into the evaporator serpentine by-passing the condenser.

The hot gas circulating into the serpentine of the evaporator warms up the copper molds causing the defrost of the ice cubes. The ice cubes, released from the cups, drop by gravity onto a slanted cube chute, then through a curtained opening they fall into the storage bin.

At the end of the defrost cycle, both the hot gas and the water inlet valves close and the machine starts again a new freezing cycle.

OPERATION - CONTROL SEQUENCE

At the start of freezing cycle, the evaporator temperature sensor controls the length of the first part of the freezing cycle. As it reaches a predetermined temperature, it supplies a low voltage current to the P.C. BOARD in order to activate the electronic timer which, takes over the control of the freezing cycle for a pre-fixed time, according to the DIP SWITCH keys setting (see Tab. B).

NOTE. The evaporator temperature sensor, factory pre-set, is the same for all the models and is not adjustable.

Once completed the freezing cycle 2nd phase the system goes automatically into the defrost cycle which also has a pre-fixed length. At completion of the defrost cycle the P.C. BOARD commands the unit to start again a new freezing cycle.

OPERATION - ELECTRICAL SEQUENCE

The following charts illustrate which switches and which components are ON or OFF during a particular phase of the icemaking cycle.

BEGINNING FREEZE

Electrical components (Loads) .	ON	OFF
Compressor	•	
Fan Motor (Air cooled only) and TRIAC	•	
Hot Gas Valve		•
Inlet Water Valve		•
P.C. Board Relay 1 Coil		•
P.C. Board Relay 2 & 3 Coil	•	
Water Pump	•	
Contacteur Coil (only MXG 638-938)		•
Electronic Timer		•

Electronic Controls & Sensors ..	ON	OFF
Evaporator Sensor		•
Condenser Sensor	•	
Ice Level Control	•	

TIMED FREEZE

Electrical components (Loads) .	ON	OFF
Compressor	•	
Fan Motor (Air cooled only) and TRIAC	•	•
Hot Gas Valve		•
Inlet Water Valve		•
P.C. Board Relay 1 Coil		•
P.C. Board Relay 2 & 3 Coil	•	
Water Pump	•	
Contacteur Coil (only MXG 638-938)	•	
Electronic Timer	•	

Electronic Controls & Sensors .	ON	OFF
Evaporator Sensor	•	
Condenser Sensor	•	•
Ice Level Control	•	

HARVEST (Drain portion - first 30 sec.)

Electrical components (Loads) .	ON	OFF
Compressor	•	
Fan Motor (Air cooled only) and TRIAC		•
Hot Gas Valve	•	
Water Inlet Valve	•	
Water Drain Valve	•	
P.C. Board Relay 1 & 2 Coil	•	
P.C. Board Relay 3 Coil	•	
Water Pump	•	
Contacteur Coil (only MXG 638-938)	•	
P.C.B. Timer	•	

HARVEST (Water filling portion)

Electrical components (Loads) .	ON	OFF
Compressor	•	
Fan Motor (Air cooled only) and TRIAC		•
Hot Gas Valve	•	
Water Inlet Valve	•	
Water Drain Valve	•	
P.C. Board Relay 1 & 2 Coil	•	
P.C. Board Relay 3 Coil		•
Water Pump		•
Contacteur Coil (only MXG 638-938)	•	
P.C. Board Timer	•	

Electronic Controls & Sensors .	ON	OFF
Evaporator Sensor		•
Condenser Sensor		•
Ice Level Control	•	

Freeze Cycle (21°C amb/15°C water)

MODEL	VOLTAGE	CUBE SIZE	REF. CHARGE (R404a - gr.)	OPERATING PRESSURE (bar)	
				at 21°C amb. / 15°C water	
				suction (beg./end freez.)	discharge
MXG 328 A		S	710	3,6 / 1,85	15 - 16,5
	230/50/1	M	610	3,1 / 1,6	14,5 - 16,5
		L	610	3 / 1,5	15 - 16,5
MXG 328 W		S			
	230/50/1	M	480	3,7 / 1,9	17
		L			
MXG 428-438 A		S	690	2,6 / 1,2	16,5 - 21
	230/50/1	M	630	2,6 / 1,1	14,5 - 16,5
		L	580	2 / 0,9	15 - 17
MXG 428-438 W		S			
	230/50/1	M	520	2,5 / 1,2	16,5 - 18,5
		L			
MXG 638 A		S	950	2,8 / 1,5	14 - 15,5
	230/50/1	M	770	2,7 / 1,1	13,5 - 16,5
		L	800	2,2 / 1	13 - 15
MXG 638 A		S			
	400/50/3	M	870	2,6 / 1,1	13 - 15
		L	940	2,9 / 1,2	13 - 17
MXG 638 W		S			
	230/50/1	M	650	2,8 / 1,5	17
		L			
MXG 938 A		S			
	400/50/3	M	2300	1,5 / 0,7	13,5 - 16,5
		L	2000	2 / 0,5	17
MXG 938 W		S			
	400/50/3	M	1700	1,5 / 0,7	17
		L	1700	2,6 / 0,9	17

NOTE. Before charging the refrigerant system always check the type of refrigerant and quantity as specified on the individual ice machine dataplate.
The refrigerant charges indicated are related to average operating conditions.

WARNING. As R 404 a is a band of different types of refrigerants it is imperative to charge the system only in liquid phase in order to avoid to alter their mix-up percentage.

COMPONENTS DESCRIPTION**A. EVAPORATOR TEMPERATURE SENSOR**

The evaporator temperature sensor probe, located in contact with the evaporator serpentine, detects the dropping of the evaporator temperature during the freezing cycle and signals it by supplying a current flow to the micro processor of P.C. BOARD.

According to the current received, the evaporator sensor supplies power to the P.C. BOARD first, when it reaches **0°C (32°F)**, second at **-15°C (5°F)**; in this second case it supply power to the electronic timer built into the P.C. BOARD so that it may take control of the length of the 2nd phase of freezing cycle. The length of the timed phase is pre-fixed by the setting of the keys 1, 2, 3 and 4 of the DIP SWITCH.

The activation of the electronic timer (-15°C - 5°F) is monitored by the lighting up of the **RED LED** placed in the front of the P.C. BOARD. This lighting up occurs usually in the mid period of the freezing cycle and signals the switching from the first to the second phase of the freezing cycle.

NOTE. Whenever, after 15 minutes from the beginning of the freezing cycle, the evaporating temperature have not yet reached the value of **0°C (32°F)**, the P.C. BOARD switches OFF the machine with the **BLINKING of RED LED.**

B. CONDENSER TEMPERATURE SENSOR

The condenser temperature sensor probe, located within the condenser fins (air cooled version) or in contact with the tube coil (water cooled version) detects the condenser temperature variations and signals them by supplying current, at low voltage, to the P.C. BOARD.

In the air cooled versions, in relation to the different current received, the micro processor of the P.C. BOARD supplies, through a TRIAC, the power at high voltage to the fan motor so to cool the condenser and to reduce its temperature. In case the condenser temperature rises and reaches 70°C (160°F) - on air cooled models - or 62°C (145°F) - on water cooled models - the current arriving to the micro processor is such to cause an immediate and total stop of the machine operation.

C. ICE BIN LEVEL LIGHT CONTROL

The electronic ice bin level control, located into the storage bin, has the function to stop the operation of the ice machine **ONLY AT THE END OF THE HARVEST CYCLE** when the light beam is interrupted by the ice cubes stored into the bin.

When the light beam is interrupted the Bin Full YELLOW LED starts blinking.

SETTING OF THE ICE LEVEL CONTROL SENSIVITY

In case of any need it's possible to up to date the sensivity of the optical ice level control as per

here below procedure:

- a) Switch OFF the machine at Master Switch
- b) Push and hold the PC Board Push Button
- c) Switch ON the machine at Master Switch
- d) Keep pushed the PC Board Push Button till the Leds of the PC Board are ON
- e) Release the PC Board Push Button.

NOTE. The setting of the Ice Level Control Sensivity must be done any time a new PC Board or a new Ice Level Control is installed in the machine.

D. P.C. BOARD (Data processor)

The **P.C. BOARD**, fitted in its plastic box located in the front of the unit, consists of two separated printed circuits one at high and the other at low voltage integrated with fuse on power out (6.3 A), of four aligned **LEDS** monitoring the operation of the machine, of one extra monitoring **RED LED** (blink 0°C - steady - 15°C), of one **DIP SWITCH** with ten keys, of one push button, of input terminals for the leads of the sensor probes and input and output terminals for the leads of the ice maker electrical wires.

The P.C. BOARD is the brain of the system and it elaborates, through its micro processor, the signals received from the three sensors in order to control the operation of the different electrical components of the ice maker (compressor, water pump, solenoid valves, etc.).

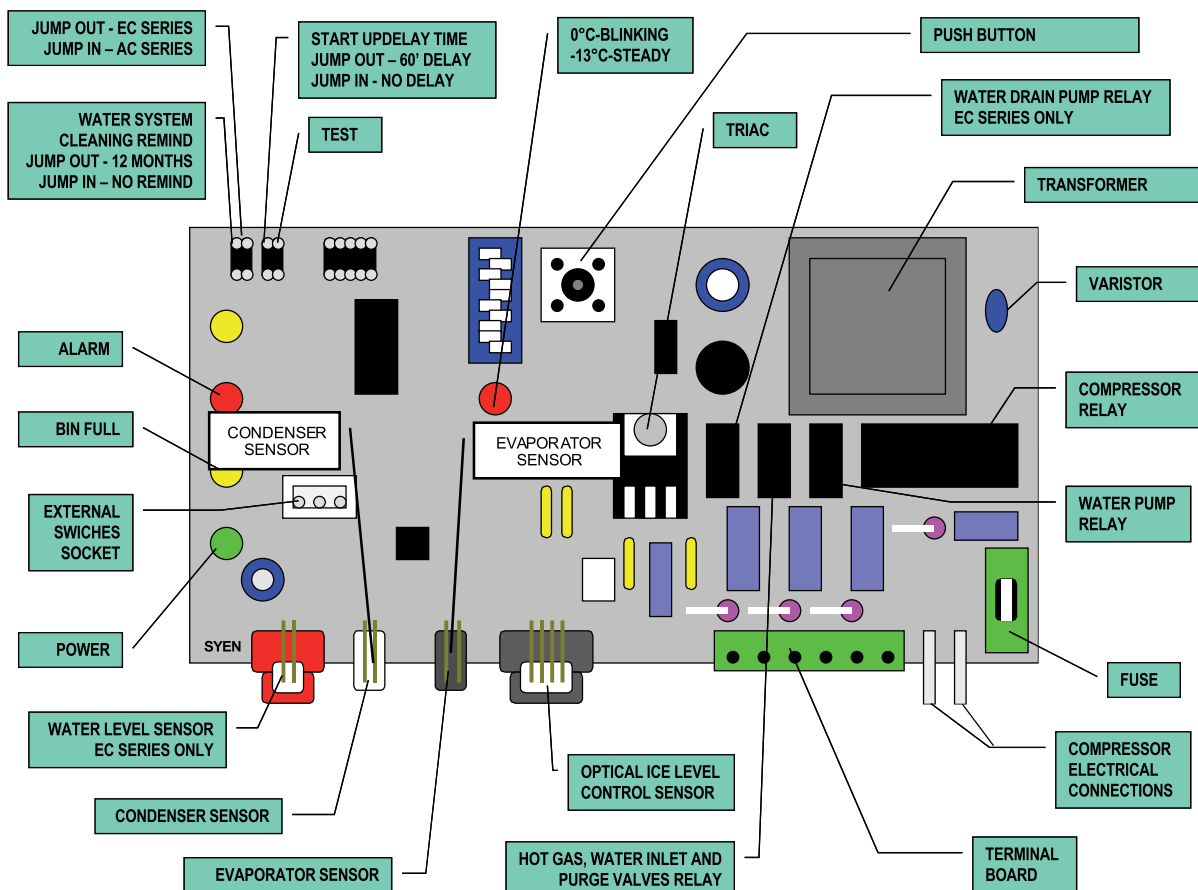

At restart, from any tripping OFF at Bin Full, the new PC Board assures 45 seconds water filling phase so to refill the water sump up to the maximum level.

In case of malfunction of the Optical Ice Level Control, the new PC Board switch ON alternatively the Yellow and Red Led continuously.

On the PC Board there are four jumpers to select:

- "no remind" or 12 months remind time for the water system cleaning
- Operation of the Purge Out Water Pump (Jump IN on EC series)
- "no delay" or 60 minutes delay time at first start up
- TEST

In case the TEST contacts are closed with the Jumper, at the Start Up of the machine the PC Board energizes all the electrical components for maximum 3 minutes time.

At the end of the 3 minutes the PC Board switch OFF the entire machine with the blinking of all the LED's as shown on the bottom drawing.

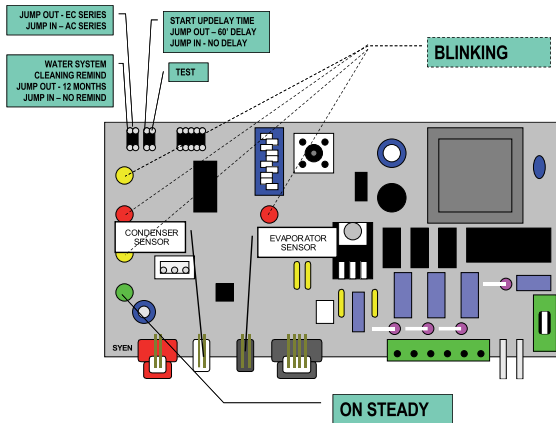

The length of Harvest is equal to:

- 35" if Push Button is activated before -15°C evaporating temperature LED activation
- As per Harvest cycle chart, if Push Button is activated after -15°C evaporating temperature LED activation (Red LED inside PC Board ON steady)

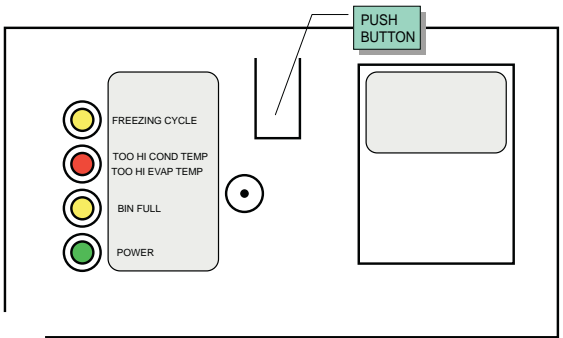

LED MEANING

GREEN LED ON
Unit under power

YELLOW BIN FULL LED ON
Unit shut-OFF at storage bin full
YELLOW BIN FULL LED BLINKING
Infrared beam break out

RED ALARM LED ON
Too hi condensing temperature
RED ALARM LED BLINKING
Too hi evaporating temperature

YELLOW FREEZING CYCLE ON
Unit in freezing cycle mode

YELLOW FREEZING LED AND RED ALARM LED ON
Condenser sensor out of order
YELLOW FREEZING LED AND RED ALARM LED BLINKING
Evaporator sensor out of order

E. PUSH BUTTON OPERATION

DURING WATER FILLING PHASE

- Push for more then 2" but less then 5" the machine enters in Cleaning Mode
- Push for more then 5" the machine by-pass the Water Filling Phase

DURING FREEZING/HARVEST CYCLE

- Push for more then 5" during the Freezing cycle the machine goes immediately into Harvest
- Push for more then 5" during the Harvest cycle the machine enters immediately in the Freezing cycle

LED	STATUS	REASON WHY
	ON STEADY	UNIT UNDER POWER
	ON STEADY	FREEZING CYCLE
	BLINKING	60 MINUTES DELAY AT START UP JUMPER J3 OUT
	ON STEADY	TOO HI DISCHARGE PRESSURE/TEMP
	BLINKING	TOO HI EVAP. TEMP. (> 0C°) AFTER 15' FROM START UP
	ON STEADY	UNIT OFF AT BIN FULL
	BLINKING SLOW	I/R BEAM CUTTED
	BLINKING FAST	I/R ON AFTER TRIP OFF AT BIN FULL
	ON STEADY	I/R CALIBRATION DONE
	BLINKING	UNIT IN CLEANING MODE OR TRIPPING OFF AFTER TEST - JUMPER TEST IN
	ON STEADY	CONDENSER SENSOR OUT OF ORDER
		EVAPORATOR SENSOR OUT OF ORDER
	BLINKING ALTERNATIVELY	I/R SENSOR OUT OF ORDER

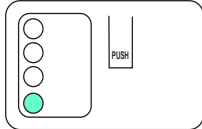

PUSH > 5" DURING WATER FILLING TO
MOVE THE UNIT INTO FREEZING

PUSH > 5" DURING FREEZING
TO MOVE THE UNIT INTO DEFROST

PUSH > 5" DURING DEFROST
TO MOVE THE UNIT INTO FREEZING

PUSH 2" > 5" DURING WATER FILLING
TO MOVE THE UNIT INTO CLEANING

PUSH DURING THE 60 MIN START UP
DELAY TIME TO BY-PASS IT

G. DIP SWITCH

The P.C.BOARD which controls the entire operation of the ice maker, has a **DIP SWITCH with ten switching keys** which allow to set up the micro processor program in order to extend or to shorten the length of freezing cycle in relation to the different model and versions of ice machines.

The DIP SWITCH first four keys setting determines the length of the 2nd phase of freezing cycle (controlled by the electronic timer) as detailed in the table B.

The DIP SWITCH keys 5 & 6 setting determines the length of the defrost cycle according to the size of the cubes (Large or Medium) as per the following setting:

- ON ON : PROGRAM A
- ON OFF : PROGRAM B
- OFF OFF : PROGRAM C
- OFF ON : PROGRAM D

LENGTH OF HARVEST CYCLE ACCORDING TO THE TIME TO DROP THE EVAP. TEMPERATURE FROM 0°C TO -15°C

LENGTH HARVEST CYCLE	PROGRAMS			
	A	B	C	D
180"	Up to 6'30"	***	Up to 9'30"	xxxx
165"	6'30"-7'	Up to 3'	9'30"-10'	xxxx
150"	7'-8'	3'-3'15"	10'-11'	xxxx
135"	8'-9'	3'15"-3'30"	11'-12'	xxxx
120"	9'-10'30"	3'30"-4'30"	12'-13'30"	< 3'
105"	10'30"-12'	4'30"-6'	13'30"-15'	3' - 4'
90"	>12'	>6'	>15'	>4'

The DIP SWITCH N° 7 and 8 allow the extension of the length of the harvest/defrost cycle according to their combination as per following chart:

DIP SWITCH		ADDITIONAL DEFROST TIME
7	8	
ON	ON	0
OFF	ON	30"
ON	OFF	60"
OFF	OFF	WATER PUMP OFF

TAB. B		LENGTH OF TIMED PORTION OF FREEZING CYCLE ACCORDING TO THE DIP SWITCH SETTING COMBINATIONS								
		1	2	3	4					
		1	2	3	4	1	2	3	4	
1	ON OFF	█	█	█	█					25 min.
2	ON OFF	█	█	█	█					23 min.
3	ON OFF	█	█	█	█					21 min.
4	ON OFF	█	█	█	█					19 min.
5	ON OFF	█	█	█	█					17 min.
6	ON OFF	█	█	█	█					15 min.
7	ON OFF	█	█	█	█					13 min.
8	ON OFF	█	█	█	█					11 min.
9	ON OFF	█	█	█	█					9 min.
10	ON OFF	█	█	█	█					7 min.
11	ON OFF	█	█	█	█					5 min.
12	ON OFF	█	█	█	█					3 min.
13	ON OFF	█	█	█	█					1 min.

The **9th key** is used to supply power to the water pump for the first **15 seconds** of the defrost cycle - **position OFF** - or for the first **30 seconds** - **position ON**.

The **10th key** is used to modify the CUT-OUT condensing temperature **from 70°C (160°F)** for the air cooled versions - **ON position** - to **60°C (140°F)** - **OFF position** - for the water cooled versions.

H. WATER SPRAY SYSTEM

Through its nozzles, the water pumped, is sprayed in each individual cup to be frozen into ice. It consists of one spray tube where are located several spray nozzles.

I. WATER PUMP

The water pump operates continually throughout the freezing cycle and on the first 15 or 30 seconds of the defrost cycle so to such the remaining water from the sump tank (reach in mineral salts) and drain it out. During the freezing cycle the pump primes the water from the sump to the spray system and through the spray nozzles sprays it into the inverted cup molds to be frozen into crystal clear ice cubes. It is recommended that the pump motor bearings be checked at least every six months.

J. WATER INLET SOLENOID VALVE - 3/4 GAS MALE FITTING

The water inlet solenoid valve is activated by the micro processor of the P.C. BOARD during the first 5 minutes of water filling phase and as well during the defrost cycle. When energized it allows a metered amount of incoming water to flow over the evaporator cavity to assist the hot gas in defrosting the ice cubes. The water running over the evaporator cavity drops by gravity, through the dribbler holes of the platen, into the sump reservoir where it will be sucked by the water pump and primed to the spray system.

K. HOT GAS SOLENOID VALVE

The hot gas solenoid valve consists basically in two parts: the valve body and the valve coil. Located on the hot gas line, this valve is energized through the micro processor of P.C. BOARD during the defrost cycle and as well during the water filling phase. During the defrost cycle the hot gas valve coil is activated so to attract the hot gas valve piston in order to give way to the hot gas discharged from the compressor to flow directly into the evaporator serpentine to defrost the formed ice cubes.

L. FAN MOTOR (Alir cooled version)

The fan motor is controlled through the P.C. BOARD and the TRIAC by the condenser temperature sensor. Normally it operates only during the freezing cycle to draw cooling air through the condenser fins. In the second part of the freezing cycle, the fan motor can run at intermittance as the condenser pressure must be kept between two corresponding head pressure values (16÷18 bars- 225÷250 psig).

M. COMPRESSOR

The hermetic compressor is the heart of the refrigerant system and it is used to circulate and retrieve the refrigerant throughout the entire system. It compresses the low pressure refrigerant vapor causing its temperature to rise and become high pressure hot vapor which is then released through the discharge valve.

N. WATER REGULATING VALVE (Water cooled version)

This valve controls the head pressure in the refrigerant system by regulating the flow of water going to the condenser. As pressure increases, the water regulating valve opens to increase the flow of cooling water.

O. THERMOSTATIC EXPANSION VALVE (TXV) - only MXG 938

The thermostatic expansion valve regulates the flow of refrigerant to the evaporator and reduces pressure of liquid refrigerant from condensing pressure to evaporating pressure. Following TXV setting according to MXG models:

Model	TXV setting
MXGM 938 AIR	FULLY CCW
MXGM 938 WATER	FULLY CCW THAN 1 TURN CW
MXGL 938 AIR & WATER	FULLY CCW THAN 3 TURNS CW

P. CONTACTOR

Placed outside of the control box it is controlled by the P.C. BOARD in order to close or open the electrical circuit to the compressor.

Q. WATER DRAIN SOLENOID VALVE

The water drain solenoid valve, electrically connected in parallel to the water inlet and to the hot gas solenoid valves, is energized for all the length of the defrost cycle. By means of the water pump, that remains energized for 30 seconds at the beginning of the defrost cycle, it allows the drain out of all remaining water (rich of minerals deposited during the previous freezing cycle) from the sump tank. By doing so it allows to the ice maker to make every new freezing cycle with new fresh water, avoiding thereby the accumulation of sediments and scales, which soon or later will cause the partial or total clogging of the water system on the unit.

R. CURRENT RELAY (3 PHASE VERSION ONLY)

Connected in series to the 3 phase compressor trips off the compressor contactor when the current of one of the three phases is more then:

Voltage	Current
230/50/3	8 Amps
230/60/3	9 Amps
400/50/3	6 Amps

ADJUSTMENT, REMOVAL AND REPLACEMENT PROCEDURES

A. ADJUSTMENT OF THE CUBE SIZE

CAUTION. Before performing actual adjustment of the cube size, check other possible causes for cube size problems, refer to the Service Diagnosis Section for problem review and analysis.

Do not perform any adjustment till the icemaking system has progressed through several complete freezing and harvest cycle, to observe size and quality of ice cubes and whether or not the cube size problem exists.

I. If the cubes are shallow size (Indentation is too deep) probably the length of the second phase of the freezing cycle is too short so, to extend such length you have to:

1. Locate the DIP SWITCH on the front of the P.C. Board.
2. Take note of the combination of the first four DIP SWITCH KEYS and check the corresponding length of freezing cycle 2nd phase on Table B.
3. Change the same DIP SWITCH KEYS setting so that it will correspond to the combination on table B pre-ceding the one remarked at step 2.
This will allow an extension of the freezing cycle of two more minutes.

4. Observe the ice cubes in the next two harvests and eventually repeat steps 2 and 3 above until proper ice cubes size is achieved. See figure.

II. If the cubes are oversize size (Indentation is too full) probably the length of the second phase of the freezing cycle is too long. To shorten such length you have to:

1. Locate the DIP SWITCH on the front of the P.C. Board.
2. Take note of the combination of the first four DIP SWITCH KEYS and check the corresponding length of freezing cycle 2nd phase on Table B.
3. Change the same DIP SWITCH KEYS setting so that it will correspond to the combination on table B coming next to the one remarked at step 2.
This will reduce an the freezing cycle length of two minutes.

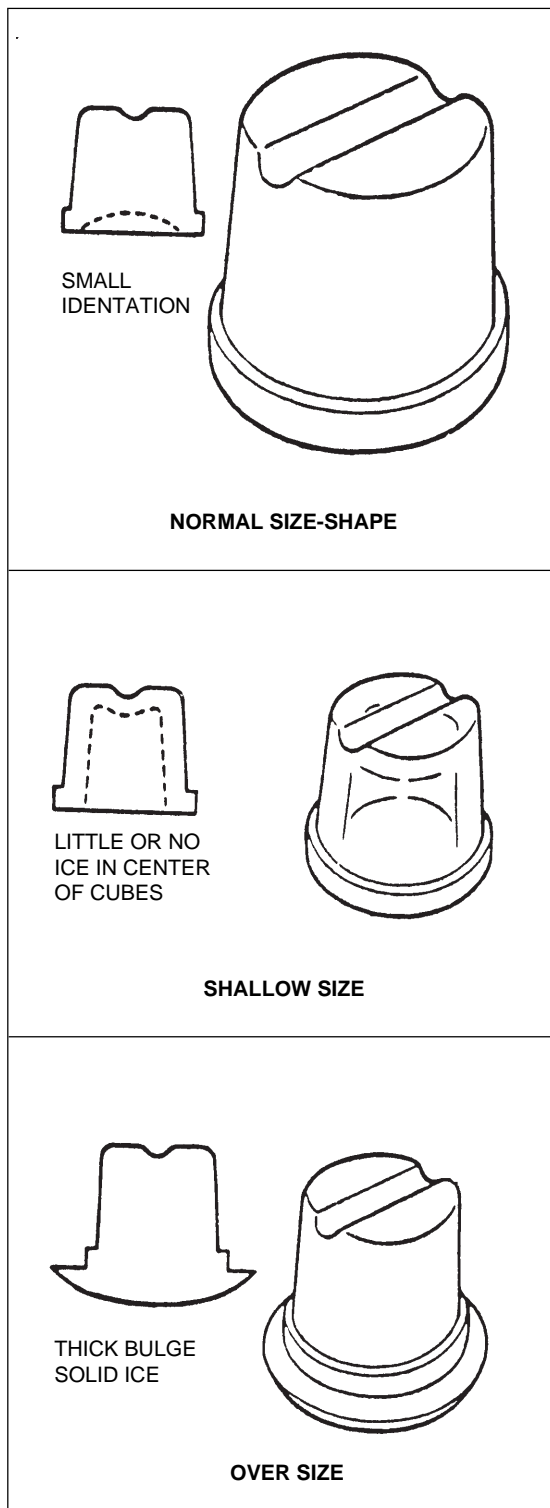

4. Observe the ice cubes in the next two harvests and eventually repeat steps 2 and 3 above until proper ice cubes size is achieved. See figure.

WIRING DIAGRAM





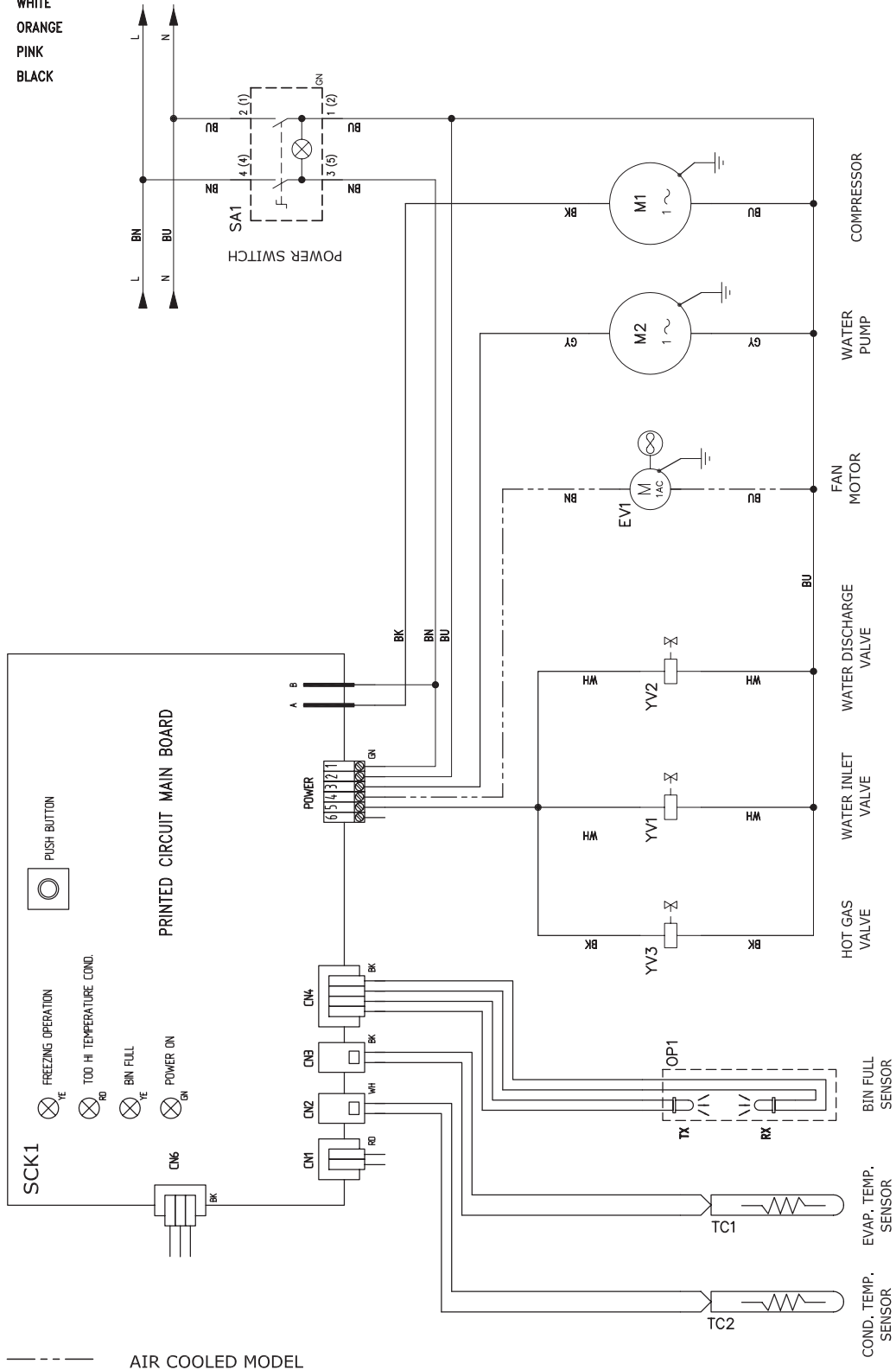

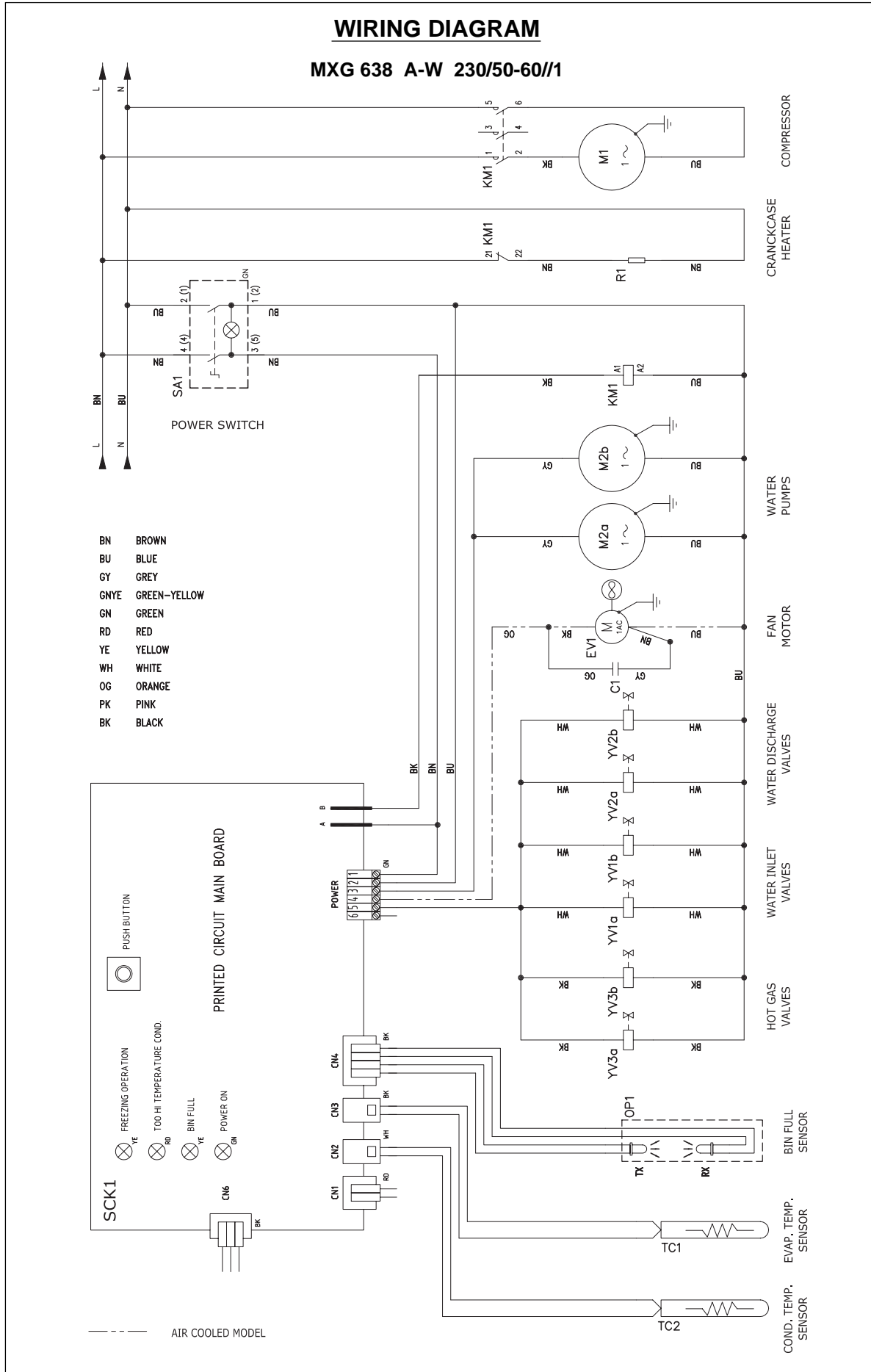

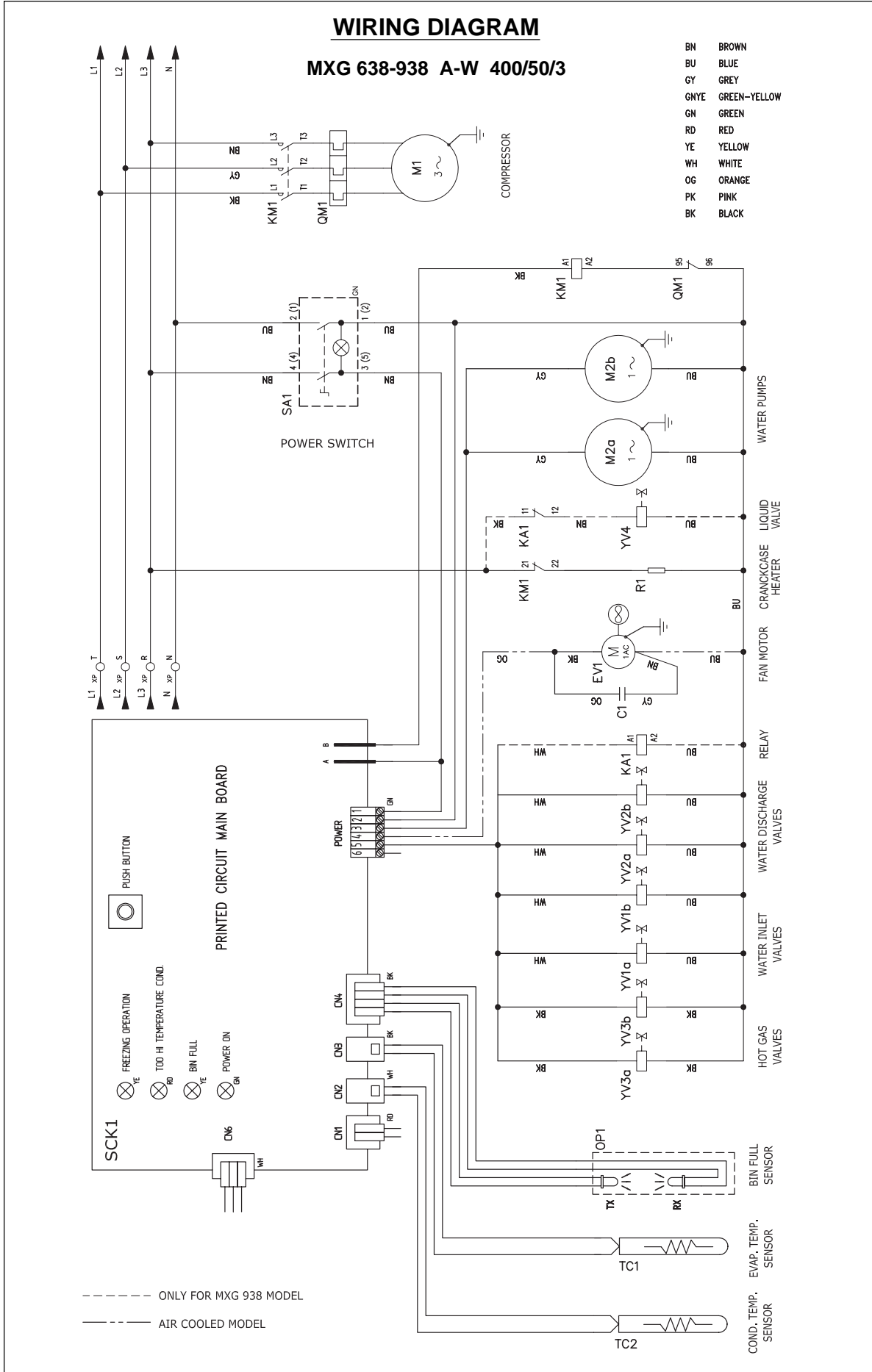





















MXG 328 - 428 - 438 A-W 230/50/1

- BN BROWN
- BU BLUE
- GY GREY
- GNYE GREEN-YELLOW
- GN GREEN
- RD RED
- YE YELLOW
- WH WHITE
- OG ORANGE
- PK PINK
- BK BLACK







Sim.\Sym.	Sigla\Item	Funzione\Use Type	Sim.\Sym.	Sigla\Item	Funzione\Use Type	Sim.\Sym.	Sigla\Item	Funzione\Use Type
	C1	Running capacitor fan motor		TC1	Evaporator temperature sensor		TC1	Evaporator temperature sensor
	EV1	Fan motor		TC2	Condenser temperature sensor		TC2	Condenser temperature sensor
	KA1	Liquid solenoid valve relay		YV3a	Hot gas valve		YV3a	Hot gas valve
	KM1	Compressor contactor		YV3b	Hot gas valve		YV3b	Hot gas valve
	M1	Compressor		YV1a	Water inlet valve		YV1a	Water inlet valve
	M2a	Water pump		YV1b	Water inlet valve		YV1b	Water inlet valve
	M2b	Water pump		YV2a	Water discharge valve		YV2a	Water discharge valve
	OP1	Bin full sensor		YV2b	Water discharge valve		YV2b	Water discharge valve
	QM1	Compressor thermal protector		YV4	Liquid solenoid valve		YV4	Liquid solenoid valve
	R1	Crankcase heater		SA1	Power switch		SA1	Power switch
	SCK1	Printed circuit main board						

SERVICE DIAGNOSIS

SYMPTOM	POSSIBLE CAUSE	SUGGESTED CORRECTION
Unit will not run (No warning LEDS glows)	Blown power in fuse in P.C.Board Main switch in OFF position Inoperative P.C.Board Loose electrical connections	Replace fuse & check for cause of blown fuse Turn switch to ON position Replace P.C.Board Check wiring
(Green LED-Power ON glows)	Blown power out fuse in P.C. Board	Replace fuse & check for cause of blown fuse
(Bin full LED glows)	Inoperative ice level control Inoperative P.C.Board	Clean or replace ice level control Replace P.C.Board
(Red-alarm LED glows)	High head pressure	Dirty condenser. Clean Inoperative fan motor. Replace Shortage of water (WC)
(Red-alarm LED blinks)	High evaporating temperature after 15 mins. beginning freeze	Hot gas valve leak - Replace it. Water inlet valve leak - Replace it. Short of refrigerant. Compressor cycles intermittently
(Freezing or Bin Full LED + Red-alarm LED glow)	Condenser sensor out of order	Replace it
(Freezing or Bin Full LED + Red-alarm LED blink)	Evaporator sensor out of order	Replace it
(Freezing or Bin Full LED + Red-alarm LED blink alternatively)	Ice Level Control out of order	Replace it
Compressor cycles intermittently	Low voltage Contactor with burnt contacts Non-condensable gas in system Compressor starting device with loose wires Mechanical problem	Check circuit for overloading Check voltage at the supply to the building. If low, contact the power company Replace it Purge the system Check for loose wires in starting device Replace compressor
Cubes too small	Freezing cycle too short Capillary tube partially restricted Moisture in the system Shortage of refrigerant	Review setting of DIP SWITCH keys Blow charge, add new gas & drier, after evacuating system with vacuum pump Same as above Check for leaks & recharge
Cloudy cubes	Shortage of water Dirty water supply Accumulated impurities	See remedies for shortage of water Use water softener or water filter Use SCOTSMAN Ice Machine cleaner
Shortage of water	Water spilling out through curtain Water solenoid valve not opening Water leak in sump area Water flow control plugged Leak of water drain valve	Check or replace curtain Replace valve Locate and repair Replace water inlet valve Replace valve

SERVICE DIAGNOSIS

SYMPTON	POSSIBLE CAUSE	SUGGESTED CORRECTION
Irregular cubes size & some cloudy	Some jets plugged Shortage of water Unit not level Spray bar not rotating	Remove spray bar & jet bearing and clean them See shortage of water Level as required Remove spray bar & jet bearing and clean them
Cubes too large	Freezing cycle too long Inoperative evaporator sensor	Review setting of DIP SWITCH keys Replace sensor
Decreased ice capacity	Inefficient compressor Leaky water valve Non-condensable gas in system Poor air circulation or excessive hot location (Red-alarm LED glows) Overcharge of refrigerant Capillary tube partially restricted Hot gas solenoid valve leaking Short of refrigerant Discharge head pressure too high	Replace Repair or replace Purge the system Relocate the unit or provide for more ventilation Correct the charge. Purge off slowly Blow charge, add new gas & drier, after evacuating system with vacuum pump Replace valve Charge to data plate indication See incorrect discharge pressure
Poor harvest	Restriction in incoming water line Water inlet valve not opening Hot gas valve orifice restricted Clogged air vented holes in mold cups Discharge head pressure too low	Check water valve strainer and flow control. If necessary enlarge the flow control orifice Valve coil with open winding Replace valve Replace hot gas valve assy Clean out holes plugged See incorrect discharge pressure
Unit won't harvest	Inoperative P.C.Board Hot gas valve not opening Water solenoid valve not opening	Replace P.C.Board Valve coil with open winding Replace valve Valve coil with open winding Replace valve
Incorrect discharge pressure	Inoperative condenser sensor Inoperative P.C.Board Water regulating valve misadjusted	Replace sensor Replace P.C.Board Adjust its setting stem
Excessive water in unit base	Water tubing leaking	Check. Tighten or replace

MAINTENANCE AND CLEANING INSTRUCTIONS

A. GENERAL

The periods and the procedures for maintenance and cleaning are given as guides and are not to be construed as absolute or invariable. Cleaning, especially, will vary depending upon local water and ambient conditions and the ice volume produced; and, each icemaker must be maintained individually, in accordance with its particular location requirements.

B. ICEMAKER

The following maintenance should be scheduled at least two times per year on these icemakers.

1. Check and clean the water line strainer.
2. Check that the icemaker is levelled in side to side and in front to rear directions.
3. Clean the water system, evaporators, bin and spray bar/s using a solution of SCOTSMAN Ice Machine Cleaner. Refer to procedure C cleaning instructions and after cleaning will indicate frequency and procedure to be followed in local areas.
4. Reach the water spray bar from the inside of the freezing chamber lifting it from its seat with its bottom race washer.

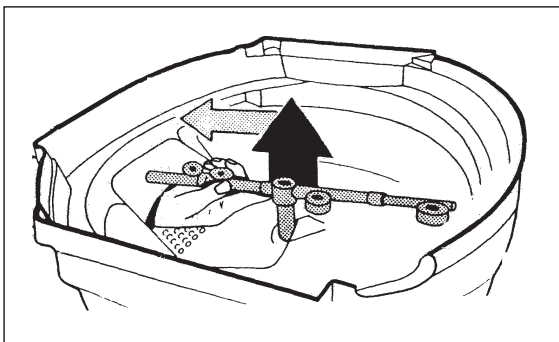

Dip it into a tray filled with cleaning solution then rinse it under a tap water stream.

With a pick clean the orifice of the water stream jet that propells the spray bar.

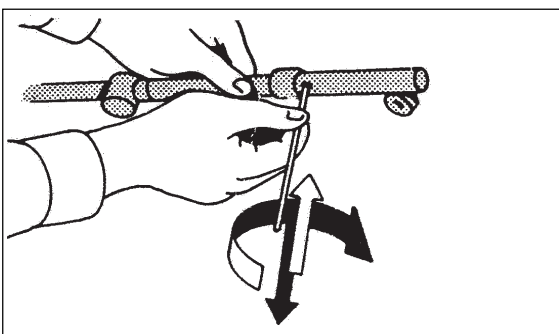

NOTE. Cleaning requirements vary according to the local water conditions and individual user operation. Continuous check of the clarity of ice cubes and visual inspection of the water spraying parts before and after cleaning will indicate frequency and procedure to be followed in local areas.

5. With the ice machine and fan motor OFF on air cooled models, clean condenser using vacuum cleaner, whisk broom or non metallic brush taking care to do not damage both the condenser and ambient temperature sensor probes.
6. Check for water leaks and tighten drain line connections. Pour water down through the storage bin drain line to be sure that drain line is open and clear.
7. Check size, condition and texture of ice cubes. Perform adjustment of DIP SWITCH keys as required.
8. Check the ice level control sensor to test shut-off. Put some ice cubes between the light source and the receiver so to cut off the light beam for at least one minutes. This should cause the ice maker to shut off and the light-up of the 2nd LED (yellow light).

IMPORTANT. Perform the above check only at the end of harvest cycle or at the beginning of freezing cycle in order to do not cause to the unit to make a double freezing cycle.

NOTE. Within few seconds after the removal of the ice cubes from the Infrared sensing light the icemaker restarts in **freezing cycle**. The ice level control uses devices that sense light, therefore they must be kept clean enough so they can "see". Every month clean/wipe the sensing "eyes" with a clean soft cloth.

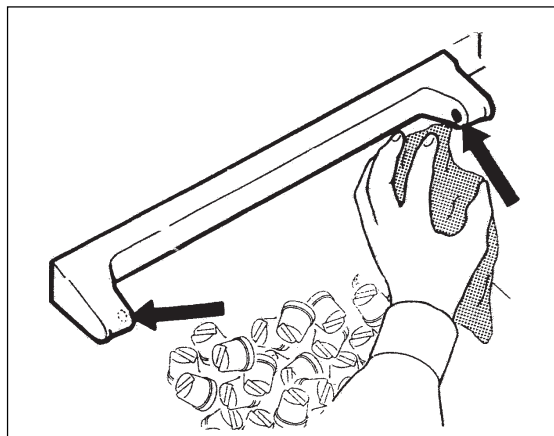

9. Check for refrigerant leaks.

C. CLEANING INSTRUCTIONS OF WATER SYSTEM

1. Remove left, center and right front panels to gain access either to the control box and to the evaporator.
2. Wait till the end of defrost cycle then turn the unit OFF by the main switch (disconnect power supply).
3. Prepare for each freezing chamber the cleaning solution by diluting in a plastic container two or three liters of warm water (45°-50°C) with a 0,2-0,3 liters of **SCOTSMAN** Ice Machine Cleaner.

WARNING. The **SCOTSMAN** Ice Machine Cleaner contains Phosphoric and Hydroxyacetic acids. These compounds are corrosive and may cause burns if swallowed, **DO NOT** induce vomiting. Give large amounts of water or milk. Call Physician immediately. In case of external contact flush with water. **KEEP OUT OF THE REACH OF CHILDREN**

4. Scoop out all the ice cubes stored into the bin in order to prevent them from being contaminated with the cleaning solution then flush out the water from the sump reservoir by bending down the vertical sump drain hose.

5. Remove the evaporator cover then slowly pour onto the evaporator platen the cleaning solution- With the help of a brush dissolve the most resistant and remote scale deposits in the platen. Perform the same for all the four evaporators.
6. Give power to the unit by the main switch.
7. During the Water Filling Phase push **RESET BUTTON** for more then 2" but less then 5" the machine enter in Cleaning Mode (Fig.7)

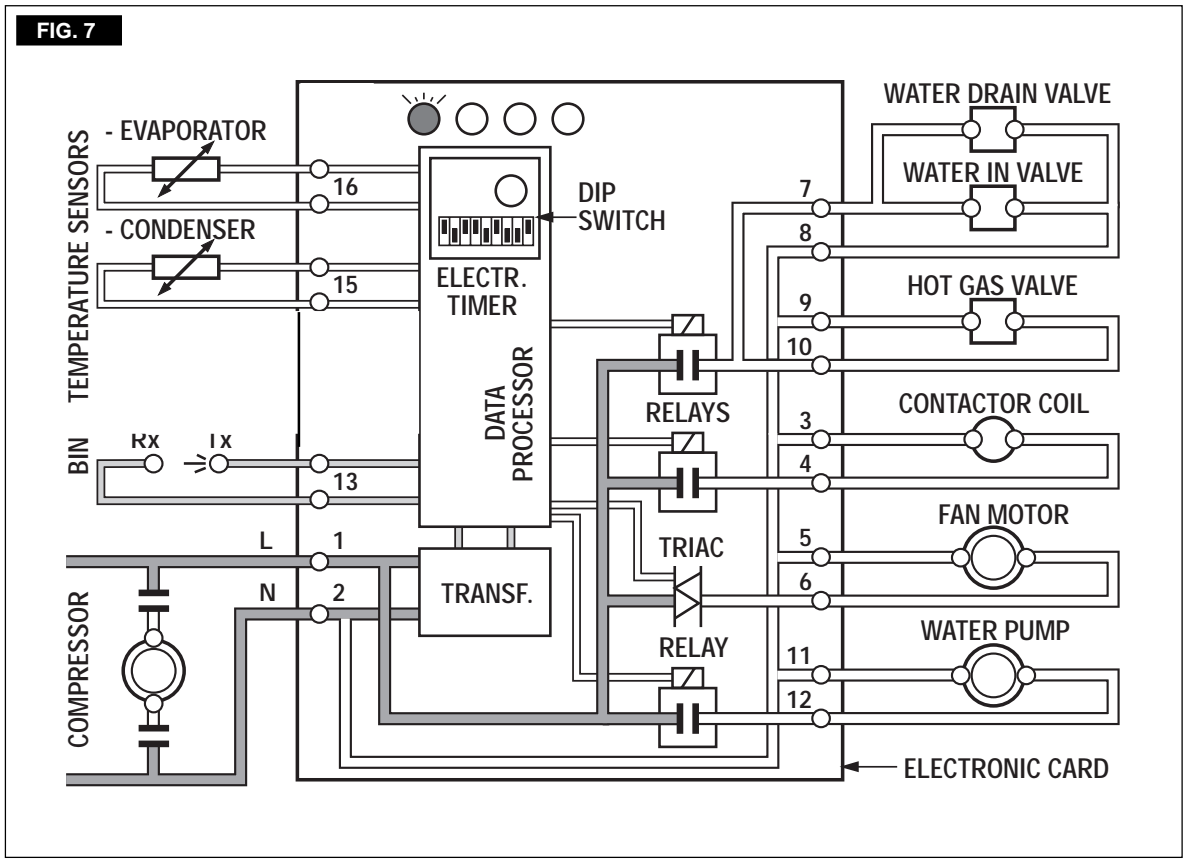
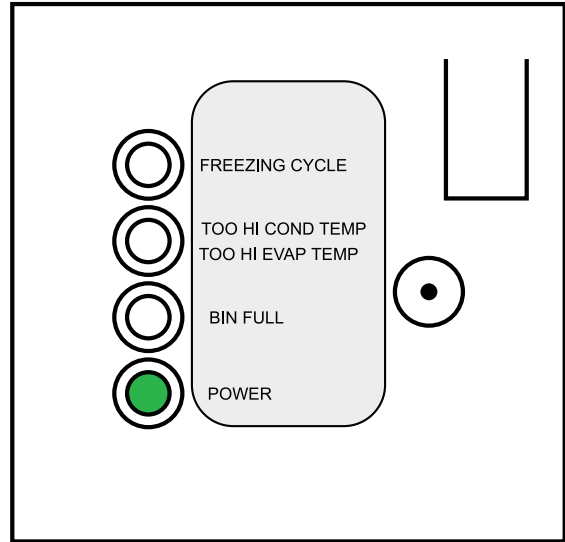

8. With the system in Cleaning mode the water pump is the only component in operation to circulate the cleaning solution in the entire water system

9. Let the unit remain in the cleaning mode for about 20 minutes then turn the main switch to OFF (disconnect unit from POWER)

10. Flush out the cleaning solution from the sump reservoirs then pour onto each evaporator cavity two or three liters of clean potable water with a capfull of antibacteria solution to rinse and sanitize the mold cups and the platen. If necessary remove the water spray bar to clean it separately as per steps 3 and 4 of paragraph B.

11. Give power to the unit by the main switch

12. During the Water Filling Phase push **RESET BUTTON** for more than 2" but less than 5" the machine enter in Rinsing Mode (Fig.7)

13. Let the unit remain in the RINSING MODE for about 10 minutes then turn the main switch to OFF (disconnect unit from POWER)

14. Flush out the rinsing solution from the sump reservoirs

15. Place again the evaporator cover and the unit service panels.

16. Give POWER to the unit.

17. At completion of the freezing and harvest cycle make sure of proper texture and clearness of the ice cubes and that, they do not have any acid taste.

ATTENTION. in case the ice cubes are cloudy, white and have an acid taste, melt them immediately by pouring on them some warm water. This to prevent that somebody could use them.

18. Wipe clean and rinse the inner surfaces of the storage bin.

REMEMBER. To prevent the accumulation of undesirable bacteria it is necessary to sanitize the interior of the storage bin with an anti-algae disinfectant solution every week.

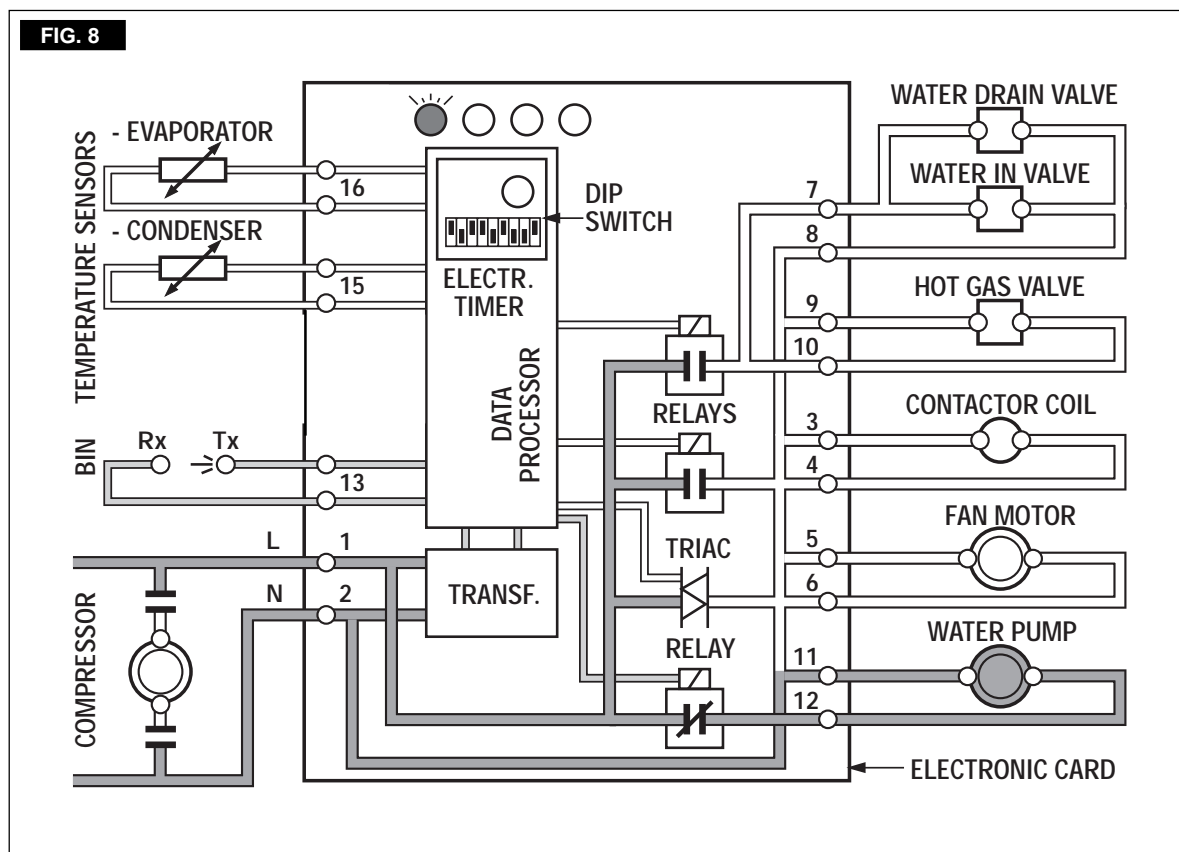

Sanitation

NOTE. *Sanitation of the water system is recommended to be done **once a month.***

19. Prepare in a plastic container the sanitation solution as per manufacturer dilution using warm water (45-50 °C).

NOTE. *Never mix the cleaning with the sanitising solution.*

20. Follow the procedures as per cleaning (from item 10 to item 13) just shorting the operation of the water pump to 10 minutes.

21. Place again the evaporator cover and the unit service panels.

22. At completion of the freezing and harvest cycle make sure of proper texture and clearness of the ice cubes and that, they do not have any acid taste.

ATTENTION. *In case the ice cubes are cloudy-white and have an acid taste, melt them immediately by pouring on them some warm water. This to prevent that somebody could use them.*

23. Wipe clean and rinse the inner surfaces of the storage bin.

REMEMBER. *To prevent the accumulation of undesirable bacteria it is necessary to sanitize every week the interior of the storage bin.*