

WAREWASHING



Hood-type dishwashers ECOMAX PLUS

H603

Installation and Operation Instructions

(Original instructions)

EN

Publisher

HOBART GmbH
Robert-Bosch-Str. 17
77656 Offenburg
Tel. +49(0)781 600 0
Fax +49(0)781 600 23 19
E-mail: info@hobart.de
Internet: www.hobart.de

Product disclaimer

Installations and repairs carried out by non-authorized technicians or using non-genuine spare parts, and any technical alterations to the machine not approved by the manufacturer will invalidate the manufacturer's warranty and product liability.

HOBART reserves the right to make changes or improvements to its products without prior notice.

© HOBART GmbH, Offenburg 2015

Table of Contents

1	Notes on the documentation	5
1.1	Application	5
1.2	Layout of the documentation	5
1.3	Representation convention	5
2	Safety instructions and regulations	7
2.1	Safety instructions and warning notices	7
2.2	Basic safety instructions	7
2.3	Property damage	10
3	Product description	11
3.1	Intended purpose	11
3.2	Conformity	11
3.3	Designation	11
3.4	Technical specifications	11
4	Controls	12
4.1	Controls	12
5	Installation	14
5.1	Personnel qualification	14
5.2	Special safety instructions	14
5.3	Transporting to the installation location	15
5.4	Removing the packaging	15
5.5	Installing the machine	15
5.6	Connecting to the power supply	16
5.7	Connecting the water	17
5.8	Connecting the drain	17
5.9	Connecting the dispenser	17
6	Commissioning	20
6.1	Personnel qualification	20
6.2	Special safety instructions	20
6.3	Setting the water hardness (optional)	20
6.4	Filling the salt reservoir (optional)	20
6.5	Filling chemical hoses	21
7	Operation	23
7.1	Personnel qualification	23
7.2	Special safety instructions	23
7.3	Preparations for washing	23
7.4	Washing	24

Table of Contents

7.5	Switch off machine	25
7.6	Executing daily cleaning	25
7.7	Executing weekly cleaning	26
7.8	Top up salt reservoir	26
8	Settings	27
8.1	Opening the operator menu	27
8.2	Exiting the operator menu	27
8.3	Making the chemical settings (option)	27
8.4	Setting the water hardness (optional)	28
9	Problems and malfunctions	29
9.1	Remedying the problem	29
9.2	Malfunctions	30
10	Maintenance	31
11	Disposal	32

1 Notes on the documentation

1.1 Application

This document contains the most important information for the installation and commissioning of the machine by qualified personnel, as well as the information required for day-to-day operation by the operator.

- ▶ Keep the operating instructions and all referenced documents in a safe and accessible place.
- ▶ If you sell the machine, pass on the installation and operating instructions.

1.2 Layout of the documentation

Referenced documents are all instructions that describe the installation, operation, maintenance and repair of the device, as well as additional instructions for all accessories used.

For the operator:





- Operating instructions

For the specialised tradesman:





- Installation instructions
- Circuit diagram
- Spare Parts Catalogue

1.3 Representation convention

1.3.1 Symbols used

Symbol	Meaning
	Warning of hazardous electrical voltage
	Beware of explosion
	Warning of risk of crushing
	Beware of hazardous substances

Notes on the documentation

Symbol	Meaning
	Beware of hand injuries
	Beware of slipping
	Beware of hazard area
	Useful additional information and tips

1.3.2 Representation in the text

Representa- tion	Meaning
NOTE	Important information on machine operation, not a warning notice
▶	Step
↳	Outcome/result
–	Listing 1st level
•	Listing 2nd level





2 Safety instructions and regulations

2.1 Safety instructions and warning notices

- ▶ During machine operation, observe the general safety instructions and warning notices that precede each action.

2.1.1 Hazard levels

The hazard level is part of the safety instructions and is denoted by the signal word. Potential consequences are differentiated by the choice of signal word.

 DANGER	imminent danger: results in serious physical injury or death
 WARNING	potentially hazardous situation: can cause serious physical injury or death
 CAUTION	potentially hazardous situation: can cause minor physical injury
 NOTICE	potentially harmful situation: can cause damage to the product or other objects

2.1.2 Layout of warning notices

Warning notices are depicted with warning symbols and signal word in the corresponding safety colours.



Nature and source of the hazard

Explanation on the nature and source of the hazard

- ▶ Measures for averting the hazard
- ▶ additional measures for averting the hazard, where applicable

2.2 Basic safety instructions

2.2.1 Product safety

The machine conforms to state-of-the-art technology and the recognised safety regulations. Nonetheless, hazards may occur.

Operate the machine only if it is in perfect working order, and in

Safety instructions and regulations

compliance with the operating instructions.

All modifications and alterations to the product are reserved for persons authorised by HOBART. Configuration is password-protected.

2.2.2 Personnel qualification

- ▶ Observe the regulations on occupational health and safety.
- ▶ Carefully read through the operating instructions before use.

Activity	User group	Qualification/training
Installation	Qualified personnel	Authorised electricians (qualified electricians or persons who have undergone equivalent training)
	Trainees	only under appropriate supervision and inspection
Commissioning	Qualified personnel	Authorised electricians (qualified electricians or persons who have undergone equivalent training)
	Trainees	only under appropriate supervision and inspection
Working on the electrical system	Qualified personnel	Qualified electrician
Operation	Laymen	Training by the operator using the operating instructions, hazard briefing
	Disabled persons	Training by the operator using the operating instructions, hazard briefing
	Children from 14 years old	Training by the operator using the operating instructions, hazard briefing, only under supervision
	Children up to 13 years old	not permitted
Maintenance, repair	Qualified personnel	Hobart Service or Hobart trained service technicians
	Trainees	only under appropriate supervision and inspection

2.2.3 Product-specific hazards

Avoid body parts being crushed or knocked:

- ▶ Observe the instructions on the packaging for storage, lifting or transporting.

Avoid risk of explosion:

- ▶ Do not install machine in a potentially-explosive location.

Avoid electric shock:

- ▶ Do not allow water to flow under live components.
 - Make sure the machine is correctly stored (see frost damage section 2.3).
 - Make sure that the machine does not overflow when being filled.
- ▶ Do not damage the connection cable while unpacking.

Safety instructions and regulations

- ▶ Have the machine connected to the power supply by qualified personnel.
- ▶ Have additional feed tanks mounted by qualified personnel.

Avoid fire risk:

- ▶ Do not allow water to flow under live components.
 - Make sure the machine is correctly stored (see frost damage section 2.3).
 - Make sure that the machine does not overflow when being filled.
- ▶ Have the machine connected to the power supply by qualified personnel.
- ▶ Have all modifications to the machine carried out by qualified personnel.

Avoid chemical burns, sensitisation of the skin, poisoning:

- ▶ Wear protective equipment (gloves, safety goggles, protective clothing) when handling chemicals.
- ▶ Use only suitable chemicals. Observe the manufacturer's data.
- ▶ Have chemical sensor system set by authorised trained service technicians.
- ▶ Do not open the machine during operation, wait for the program to finish.
- ▶ Disconnect the machine from the mains prior to cleaning.
- ▶ For cleaning, wear protective equipment (gloves, safety goggles, protective clothing) when touching parts contaminated by detergent.

Avoid burns, scalds (to the hands):

- ▶ Do not open the machine during operation or the evaporation phase, wait for the program to finish.
- ▶ Disconnect the machine from the mains prior to cleaning.
- ▶ For cleaning, wear protective equipment (gloves, safety goggles, protective clothing) when touching parts contaminated by washing solution.

Avoid slipping:

- ✓ Moisture can build up on the machine floor.
- ▶ Provide a floor covering that is guaranteed to be non-slip in case of moisture.

Residues on the washware, hygiene regulations not maintained.

- ▶ Hygiene regulations must be maintained and/or demonstrated in accordance with the national provisions.

2.2.4 Additional hazards

Potential hazards caused by operating resources to be used can be found in the enclosed safety datasheets. Workplaces must be

Safety instructions and regulations

signed accordingly.

2.3 Property damage

Avoid frost damage:

- ✓ Temperatures below 0°C during transport/storage cause function impairments.
- ▶ Prior to installation, store the machine at room temperature (min. 15°C) for 24h.

Avoid water damage:

- ▶ Configuration is password-protected and permitted only by certified service technicians. Observe documentation.
- ▶ Do not operate the machine unsupervised.
- ▶ Close site shut-off valves at end of operation.

Avoid environmental hazards:

- ▶ Dispose of the machine correctly and in accordance with environmental regulations (see section [11](#))

3 Product description

3.1 Intended purpose

The machine is an item of technical equipment intended solely for commercial dishwashing.

The machine is designed solely for cleaning crockery (porcelain, glass, ceramic, temperature-resistant plastics or stainless steel or similar) from the food industry.

Not for washing:

- Containers that do not come into contact with foodstuffs, such as ashtrays, candlesticks, electric appliances etc.
- Animals or textiles
- Foodstuffs intended for further consumption

3.2 Conformity

See separate EC Conformity Declaration.

3.3 Designation

The rating plate is located at the side of the machine and contains the following information: model, serial number, date of manufacture, country of manufacture, voltage, connection rating, design-state number and CE mark.

3.4 Technical specifications

Dimensions (H x W x D)	1480 x 635 x 742 mm
Water consumption per basket	2.8 l
Flow pressure	0.5 – 10 bar (min. 0.8 bar with integrated softener)
Cold or hot water connection	max. 60°C
Voltage	see rating plate
Total connected load	
Fuse protection	
Tank capacity (l)	23
Rack height	440
Noise emission dB (A) (workplace-related emission value)	67
Weight (kg)	100

4 Controls

4.1 Controls

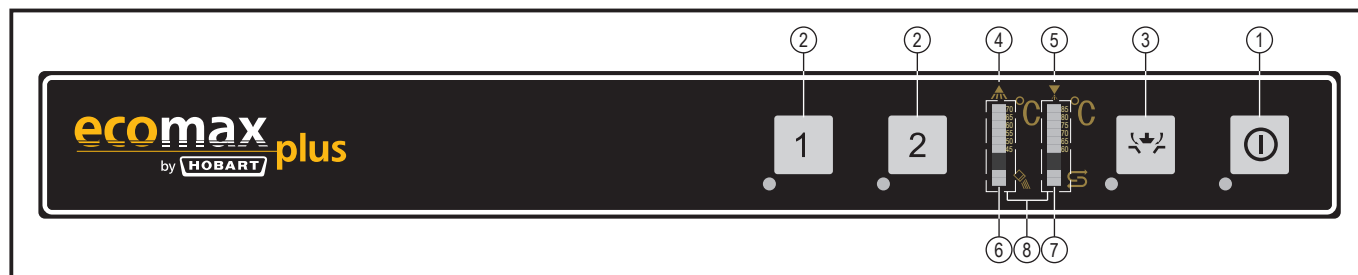

①	ON/Escape key	<p>Pressing this key switches the machine on. LED illuminates after being pressed.</p> <ul style="list-style-type: none"> – LED flashing = machine being filled and heated. – LED permanently lit = machine is ready for operation. <p>In case of operating error or faults, the machine can be switched off immediately without the drain cycle by pressing this key. After switch off, however, the machine is not voltage free.</p>
②	Program keys	<p>Press these keys to choose between short program (1) and standard program (2). The corresponding LED illuminates.</p>
③	Drain/OFF key	<p>Pressing and holding (3 seconds) this key activates the automatic self-cleaning cycle and then switches off the machine automatically. On machines with drain pump, the tank is emptied. After switch off, however, the machine is not voltage free.</p>
④	Temperature display, washing	
⑤	Temperature display, rinsing	
⑥	Salt deficiency display	Indicates regenerating salt deficiency in the water softener (if built-in).
⑦	Regeneration display	<p>Water softener regeneration active. Program run time can extend.</p>

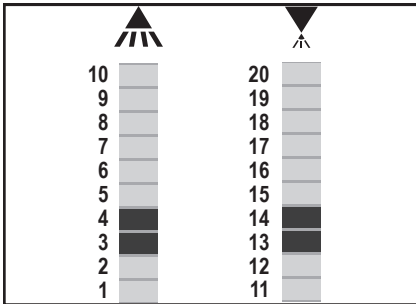
⑧ Setting functions display	<p>The individual LEDs are also used for various settings and special functions.</p>  <p>Left display: LEDs 1 to 5 illuminate depending on the function selected.</p> <ul style="list-style-type: none">1 = Detergent dosing time2 = Rinse aid dosing time3 = Hardness setting4 = Hose fill, detergent5 = Hose fill, rinse aid <p>Right display: Indicates the set value.</p>
-----------------------------	--

5 Installation

5.1 Personnel qualification

Installation must only be carried out by qualified personnel (see section 2.2.2).

5.2 Special safety instructions



WARNING

Risk of electric shock, fire hazard

Water (frost damage, machine overflow) flowing over live components can cause injury from electric shock or fire.

- ▶ Do not allow water to flow under live components.
- ▶ Make sure the machine is correctly stored (see frost damage section 2.3).
- ▶ Make sure that the machine does not overflow when being filled.



CAUTION

Risk of being crushed or knocked

When being lifted or transported, the machine can overturn or fall and cause injury.

- ▶ Observe the instructions on the packaging for storage, lifting or transporting.



WARNING

Risk of explosion

Installing the machine in a potentially explosive location can cause explosion and serious injury from ejected parts.

- ▶ Do not install machine in a potentially-explosive location.

NOTICE

Frost damage

Temperatures below 0°C during transport/storage cause function impairments.

- ▶ Prior to installation, store the machine at room temperature (min. 15°C) for 24h.

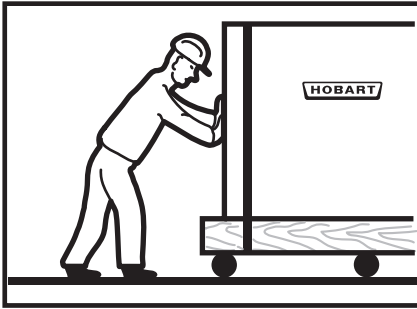

5.3 Transporting to the installation location

- ▶ Where possible transport packed on the pallet.
- ▶ Use suitable transport means (elevating truck, crane etc.).
- ▶ If using a forklift, shim the machine with wooden trusses.

5.4 Removing the packaging

CAUTION

Risk of electric shock, fire hazard

When the machine is unpacked, the connection cable can become damaged and cause injury from electric shock or fire.

- ▶ Do not damage the connection cable while unpacking the machine.
- ▶ Take cable measurement BGV A3.

- ▶ Remove packaging materials and accessories from the machine.
- ▶ Inspect the machine for possible transport damage.



5.5 Installing the machine

WARNING

Risk of electric shock, fire hazard

Water ingress can cause short circuit and mortal danger from electric shock and fire.

- ▶ As a protection against penetrating water, the rear side of the machine must be sealed.
- ▶ If this cannot be guaranteed, a back covering must be also ordered.

- ▶ Seal the machine against the wall, or attach the optionally-available back covering.
- ▶ Cut-outs in the rear machine frame for supply lines etc., must also be sealed (sealing kit 01-539610-001 optionally available).
- ▶ Align machine by turning the adjusting feet by using a spirit level.

Installing the machine in the corner:

- ▶ Maintain a side wall clearance of 107 mm.

Installing the machine in a room:

- ▶ Attach the optionally-available back covering.

Converting to corner operation



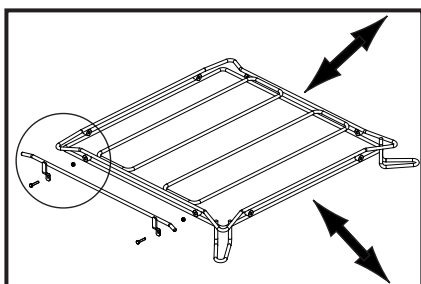
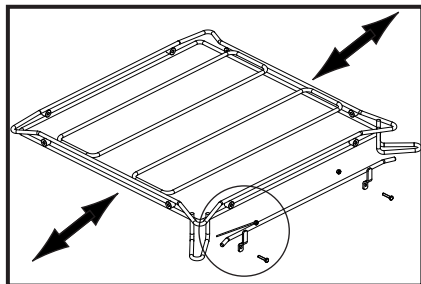

Modify the basket guide rails in accordance with the pass-through direction (see arrows):

- ▶ Remove the front side guides by loosening the screws.

- ▶ Re-mount the side guide in accordance with the pass-through direction.

5.6 Connecting to the power supply



WARNING

Risk of electric shock

Failure to connect properly to the power supply can cause mortal danger from electric shock.

- ▶ Have the machine connected to the power supply by an authorized technician according to the local and national codes. For Australia: in accordance with AS/NZS3500.1

NOTE: To guarantee the electrical safety of the machine, it must be connected to a protective earthing equipment conductor installed as specified. In addition, the machine must be connected on site to the equipotential bonding connection. The connecting screw () provided for this purpose is located next to the cable inlet.

These fundamental safety requirements and the professional design of the on-site installation must be verified by a qualified electrician.

Hobart does not accept any liability for damage caused by improper installation! Any applicable local installation instructions must be observed!

The mains cable must be connected via a cut-out device (main switch or accessible plug device).

Modification to an alternative power supply is possible as per the variants on the circuit diagram. Connection diagrams are located adjacent to the connection terminals.

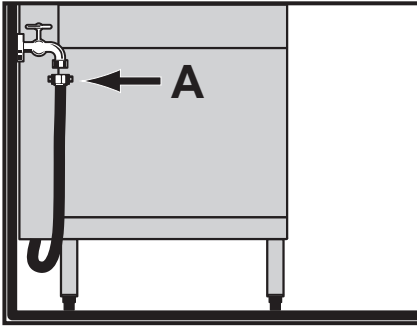

5.7 Connecting the water

NOTICE

Property damage

The use of old hose sets for connection to the water supply facility can cause water damage.

- ▶ The included connection hose must be used for connection to the water supply facility.
- ▶ Old hose sets cannot be reused.

NOTE: The machine must be operated with potable water.

- ▶ If possible, connect to warm water (max. 60°C).

Water hardness:

- Machines without softener: max. 1 °d = 0.18 mmol/l.
- Machines with softener: max. 30 °d = 5.3 mmol/l.

Flow pressure:

- Machines without softener: 0.5 – 10 bar
- Machines with softener: 0.8 – 10 bar
- If the flow pressure is higher: provide pressure reducing valve.
- ▶ Connect the union nut “A” (3/4” thread) of the water supply hose to the site shut off valve.
- ▶ Do not kink or cut the water supply hose.
- ▶ Any required extension must be executed using a suitable pressure hose, e.g. 324088-1.

5.8 Connecting the drain

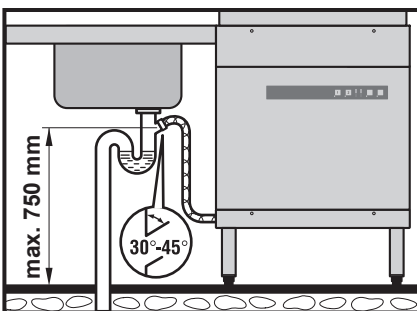

Machines with drain pump

The connection between machine and site drain must not exceed the max. height of 0.75 m.

- ▶ Do not kink or lay the drain hose loose on the ground.

5.9 Connecting the dispenser

Some model variants are factory-equipped with integrated dispensers. When converting or installing different dispensers, make the connection as follows.

- ▶ Drain tank.
- ▶ Turn off on site main switch or remove the plug.



- ▶ Remove frontal covering.

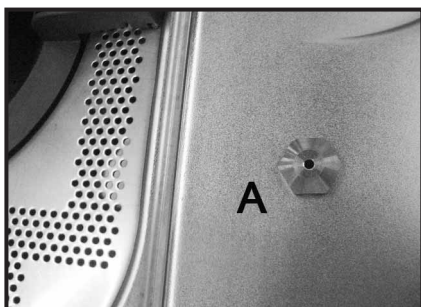

Connecting the liquid dispenser:

- ▶ A metering nipple is available on top of the boiler for dispensing rinse aid.
- ▶ For detergent dosing, connect the hose (PVC / Ø 6 mm outside × Ø 4 mm inside) between the pressure side of the dispenser and the metering nipple (A) on the wash tank, secure with hose clamp.



- ▶ Install dispenser or mount externally.

To connect a powder or solid detergent dispenser:

- ▶ Remove the side cover (depending on left or right connection).
- ▶ Break out sheet perforation on the sheet outer jacket.

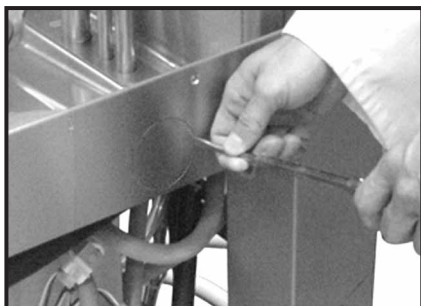

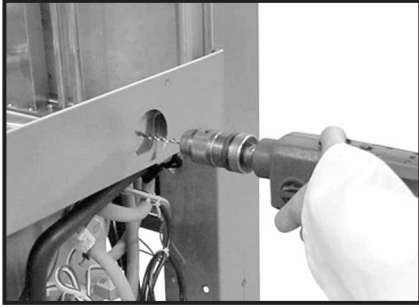

- ▶ Drill out the inner tank wall behind according to the required connection diameter.

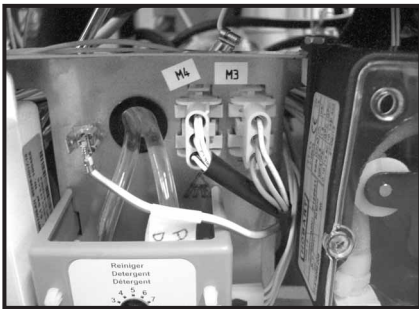

- ▶ Screw the dosing connection tightly to the tank wall.
- ▶ Connect the plug of the cable harness to the dispenser (max. 100 VA).

Installing the connectivity probe:

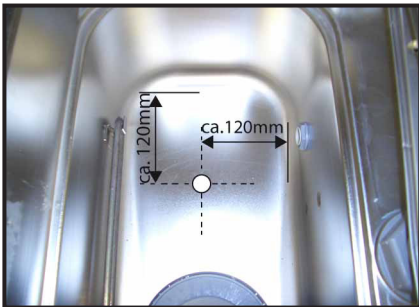

- ▶ Conductivity probe should be installed at the flat part of tank bottom.
- ▶ Drill out the tank according to the probe diameter.

- ▶ Replace cover(s).
- ▶ Turn on site main switch or insert the plug.
- ▶ Set the dispenser and the sensor system.

6 Commissioning

6.1 Personnel qualification

Commissioning must only be carried out by qualified personnel (see section 2.2.2).

6.2 Special safety instructions

NOTE: Before commissioning the machine, the relevant electrical safety checks must be performed according to the locally applicable regulations!

6.3 Setting the water hardness (optional)

Machines with integrated softener have a water hardness setting.

Note: The softener must be set to the existing water hardness (ask at the local water works).

- ▶ Set hardness range according to 8.4.

6.4 Filling the salt reservoir (optional)

NOTICE

Property damage

Accidentally filling the salt reservoir with detergent will damage the water softener.

- ▶ Do not fill the salt reservoir with detergent.



Unlike the regular salt fill, additional water has to be added during the commissioning procedure.

- ▶ Open Hood.
- ▶ Unscrew the salt reservoir lid and use the funnel provided to add 1.5 kg of granular (2-8 mm) regenerating salt (do not use salt tablets).

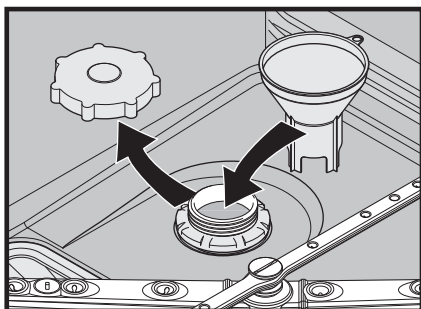

- ▶ Fill up the reservoir with potable water (only at commissioning).

- ▶ Make sure the lid seal is free of dirt and salt.
- ▶ Screw lid back on and tighten.

NOTICE

Property damage

Salt residues on the tank floor cause corrosion damage.

- ▶ Remove salt residues by hand.
- ▶ On completion of the commissioning procedure, start a wash cycle to remove all traces of salt if necessary.

6.5 Filling chemical hoses

NOTE: Only for installed dosing units



We recommend the use of HOBART Hyline detergent and rinse aid.



CAUTION

Chemical burns, sensitisation of the skin, poisoning

The use of unsuitable chemicals can cause injury.

- ▶ Use only commercial detergent and rinse aid.
- ▶ Observe the manufacturer's application and safety instructions.



WARNING

Chemical burns, sensitisation of the skin, poisoning

Filling the chemical container or chemical hoses with detergent or rinse aid for the first time incorrectly can cause serious injury.

- ▶ Wear protective equipment (gloves, safety goggles, protective clothing) when handling chemicals.



6.5.1 Provisioning external chemical canisters

Preparing the detergent:

- ✓ Suction height of dosing pump: max. 1.5 m.
- ▶ Place suction hose **without** colour marking at the suction valve at the bottom of the external reservoir.

Preparing the rinse aid:

- ✓ Suction height of dosing pump: max. 1.5 m.
- ▶ Place suction hose with **blue** marking at the suction valve at the bottom of the external reservoir.

6.5.2 Filling the intake hoses

NOTE: Possible only when the machine is switched off.

- ▶ Open Hood.
- ▶ Press the two PROGRAM keys ② at the same time.
 - ↳ Key LEDs illuminate.
 - ↳ In the display ⑧, LEDs 1 and 11-20 illuminate (depending on basic setting).
- ▶ Press PROGRAM key “1” repeatedly until LED 3 illuminates in the display ⑧.
- ▶ Close Hood.
- ▶ Press PROGRAM key “1” again.
 - ↳ Display ⑧ LED 4 illuminates.

Filling the cleaner hose:

- ▶ Press PROGRAM key “2” and hold down until the intake hose is visibly filled.
 - ↳ The hose is being filled.
 - ↳ Running light display ⑧ LEDs 15–18.

Releasing the key interrupts the filling process.

Filling the rinse aid hose:

- ▶ Press program key “1” again.
 - ↳ Display ⑧ LED 5 illuminates.
- ▶ Press PROGRAM key “2” and hold down until the intake hose is visibly filled.
 - ↳ The hose is being filled.
 - ↳ Running light display ⑧ LEDs 15–18.

Releasing the key interrupts the filling process.

Aborting the hose filling process:

- ▶ Open Hood or do not press any key for 30 seconds.

7 Operation

7.1 Personnel qualification

The machine must be operated by instructed personnel (see section 2.2.2).

7.2 Special safety instructions

CAUTION

Chemical burns, sensitisation of the skin, poisoning

If the Hood is opened during operation, wash water can spurt out and cause injury.

- ▶ Do not open the Hood during operation, wait for the program to finish.



WARNING

Slipping

Moisture can build up on the machine floor and cause slipping.

- ▶ Provide a floor covering that is guaranteed to be non-slip in case of moisture.



7.3 Preparations for washing

7.3.1 Preparing the machine

- ▶ Check correct position of wash/rinse arms and strainers.
- ▶ Open site shut-off valve.
- ▶ Turn on main switch or insert the plug.
- ▶ Check level of detergent and rinse aid containers.
- ▶ Close Hood.
- ▶ Press the ON/OFF key ①.
 - ↳ Machine is switched on.
 - ↳ The tank is filled.

During the filling and heating processes, the key LED flashes. This process can take several minutes.

As soon as the LED is permanently lit, the machine is ready for operation.

7.3.2 Preparing the washware

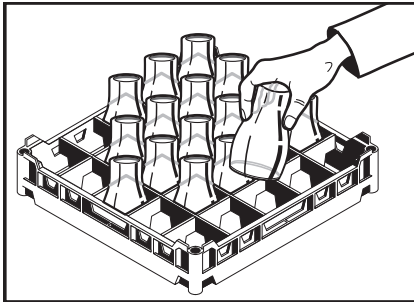

- ▶ Remove large food scraps.
- ▶ Place washware face down in the rack.

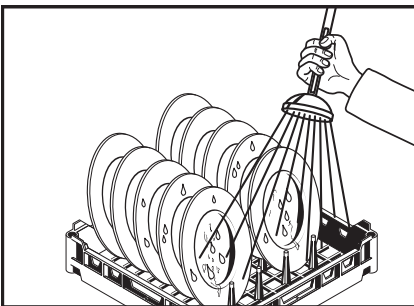

- ▶ Rinse off washware.

7.4 Washing

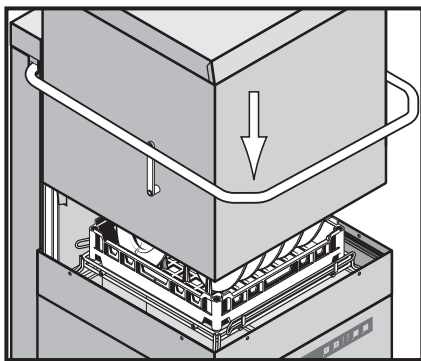

- ▶ Slide rack into the machine and close the hood.

- ▶ Start either program 1 or 2 via the respective key.

Key "1" = short program

Key "2" = standard program

↳ While the program is running, the program key LED flashes.

↳ As soon as the LED is permanently lit, the rinsing process is complete.

- ▶ Open the hood and remove the rack.
- ▶ Allow the washware enough time to dry.

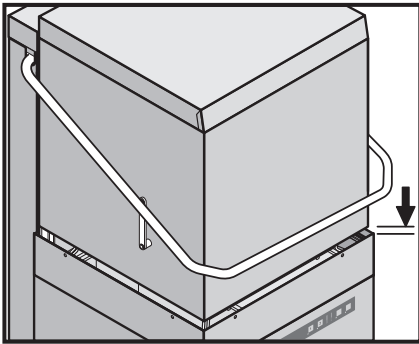

- ▶ Until the next wash process, place the hood in the stand-by position (engaged position just before closing), to prevent cooling down.

7.5 Switch off machine

- ▶ Close Hood.
- ▶ Press the DRAIN key ③ for three seconds.
 - ↳ During evacuation, the DRAIN key LED illuminates.



During the drain cycle, the machine interior is cleaned automatically. On machines with drain pump, the tank is emptied. At the end of the program, the machine switches off automatically. Then remove any food debris.

- ✓ When the machine has been switched off:
 - ▶ Turn off main switch or remove the plug.
 - ▶ Close on-site shut-off valve.

7.6 Executing daily cleaning

NOTICE

Property damage

The use of unsuitable agents can cause corrosion damage.

- ▶ Do not use any chloric, acidic or metal-containing additives to clean the machine.
- ▶ Do not use metal brushes.

- ▶ Open hood.
- ▶ Remove sieves and clean. **Make sure that food debris does not enter pump intake!**
- ▶ Clean machine areas that cannot be reached by the water circulation of the self cleaner (hood labyrinth, rear side riser pipe, etc.).
- ▶ Replace strainer.
- ▶ Leave the hood open for ventilation.

7.7 Executing weekly cleaning

- ▶ Loosen screw or clip fastener on the wash and rinse arms. Remove the wash and rinse arms and clean..
- ▶ Reinsert wash and rinse arms.

7.8 Top up salt reservoir

- ✓ The salt deficiency display © flashes during operation.
- ▶ Top up salt reservoir, see [6.4](#).
 - ↳ The display takes a few minutes to extinguish.

8 Settings

The machine can be operated as soon as the commissioning procedure is complete.

The following settings can be individually set as required using the operator menu.

8.1 Opening the operator menu

NOTE: Possible only when the machine is switched off.

- ▶ Open Hood.
- ▶ Press the two PROGRAM keys ② at the same time.
 - ↳ Key LEDs illuminate.
 - ↳ In the display ⑧, LEDs 1 and 11-20 illuminate (depending on basic setting).

8.2 Exiting the operator menu

- ▶ Open the Hood and close it again, or do not press a button for 30 seconds!
 - ↳ The display switches off.
 - ↳ The configured settings will be saved.

8.3 Making the chemical settings (option)



CAUTION

Chemical burns, sensitisation of the skin, poisoning

The use of unsuitable chemicals can cause injury.

- ▶ Use only commercial detergent and rinse aid.
- ▶ Observe the manufacturer's application and safety instructions.



Setting	Selection
Detergent dosing	One LED = approx. 3.5 s ≈ 1 g/l Factory setting: LED 11-13 = 10.5 s ≈ 3 g/l Possible range: 0–10 g/l
Rinse aid dosing	One LED = approx. 0.7 s ≈ 0.1 g/l Factory setting: LED 11-13 = 2.1 s ≈ 0.3 g/l Possible range: 0.1–1.0 g/l

Making the settings:

- ▶ Open the operator menu, see section 8.1.
 - ↳ Key LEDs illuminate.
 - ↳ In the display ⑧, LEDs 1 (left) and 11-20 (right) illuminate.
 - ↳ The right display shows the set value for the cleaner dosing time.

Setting the detergent dosing quantity

- ▶ Press PROGRAM key “2” until the desired value is displayed.

Setting the rinse aid dosing quantity

- ▶ Press PROGRAM key “1” again.
 - ↳ In the display ⑧, LEDs 1 and 2 (left) and 11-20 (right) illuminate.
 - ↳ The right display shows the set value of the rinse aid dosing time.
- ▶ Press PROGRAM key “2” until the desired value is displayed.

8.4 Setting the water hardness (optional)

With optional softener only.

Note: The softener must be set to the existing water hardness (ask at the local water works).

LED “on”	Hardness range	Water hardness
11	H01	up to 7°dH
11 and 12	H02	8 to 14°dH
11 to 13	H03	15 to 21°dH
11 to 14	H04	22 to 30°dH

Making the settings:

- ▶ Open the operator menu, see section 8.1.
 - ↳ Key LEDs illuminate.
 - ↳ In the display ⑧, LEDs 1 (left) and 11-20 (right) illuminate.
- ▶ Press program key “1” again.
 - ↳ In the display ⑧, LEDs 1 and 2 (left) and 11-20 (right) illuminate.
- ▶ Press program key “1” again.
 - ↳ In the display ⑧, LEDs 1 to 3 (left) and 11-20 (right) illuminate.
 - ↳ The right display indicates the set water hardness value.
- ▶ Press PROGRAM key “2” until the desired value is displayed.

9 Problems and malfunctions

9.1 Remediating the problem

9.1.1 Poor wash result

Nature of the problem	Possible cause	Remedy
Washware not clean.	Wash arms stiff (you should be able to turn them easily by hand).	Remove wash arms and clean them thoroughly. Also check water outlet from machine to wash arms is clear.
	Wash arm nozzles are clogged (visual check).	Remove wash arms, remove cleaning caps and rinse wash arms thoroughly until all contamination is removed. Replace cleaning caps.
	Rinse nozzles clogged (usually by lime deposit).	Remove rinse arms and decalcify them in separate container. Check site softener system for function.
	Regeneration concentration is too low or too high.	Check detergent concentration setting.
	Coarse strainer clogged.	Remove, empty and clean strainer.
	Wrong program selected for heavily soiled washware.	Select program with longer wash cycle.
Washware dries poorly.	Rinse aid dosing too low.	Increase concentration (see operating instructions).
	Washware still greasy.	Detergent concentration too low: increase (see operating instructions). Check if detergent is appropriate. If not, choose a stronger one. Drain contaminated water and refill machine. Clear washware more thoroughly beforehand.
	Rack is not suitable for type of dishes (sloping).	Use appropriate racks to create a sloping position which allows water to drain away from cavities.
	Washware remains in the machine too long at the end of rinse cycle.	Remove washware as soon as cycle is completed to enable it to dry.

Problems and malfunctions

Nature of the problem	Possible cause	Remedy
Streaks and stains on washware.	Rinse aid concentration too high (stripe or bubble formation).	Reduce concentration (see operating instructions).
	Hard water or high mineral content.	Check water quality. Every local water works holds data on the composition of the water they supply and will provide these on request. Reference values: Ideal hard water value: 0 - 3 °d (total hardness). Ideal mineral content value: for glasses, max. conductivity 100 µS/cm, for dishes, still viable to max. 400 µS/cm.
	Rack is not suitable for type of dishes (sloping).	Use appropriate racks to create a sloping position which allows water to drain away from cavities.
	Inadequate rinse aid dosing causes stains.	Increase rinse aid dosing (see operating instructions).
	Machines with integrated softener: use of wrong salt (e.g. tablets).	Do not use salt tablets.

9.1.2 Other problems

Nature of the problem	Potential causes	Remedy
Glasses are totally or partially cloudy.	Surface of glasses is rough and porous, this is called glass corrosion.	Use new glasses, this is not caused by a malfunction on the machine.
Glass/dish breakage.	Use of unsuitable dish or glass racks.	Use suitable racks.

9.2 Malfunctions

Nature of the problem	Potential causes	Remedy
Machine switches off suddenly during operation.	Machine coupled to a maximum system or locked against other current consumers.	Have machine connected separately (electrician!).
	A site fuse has tripped.	Check site fuses.
	Temperature sensor/pressure transmitter, boiler or tank defective.	Contact your Service Partner.
All 4 key LEDs flash.	Controller faulty	Contact your Service Partner.

10 Maintenance



In order to maintain the warranty, as well as a permanently safe, efficient, and trouble-free operation of the machine(s), the required maintenance must be carried out by authorized service technicians.

We therefore recommend the conclusion of an inspection and maintenance contract, which guarantees qualified support by specially trained service technicians according to a time schedule based on the operating conditions.

11 Disposal



The machine operator is responsible for disposing of the machine and its operating materials correctly and in accordance with environmental regulations. Observe the national and local legal provisions and regulations.

HOBART GmbH

ecomax by HOBART
Robert-Bosch-Str. 17
77656 Offenburg
Deutschland
Tel.: +49 (0)1803 66 29
Fax: +49 (0)1803 63 29.600-23 19
E-Mail: info@ecomaxbyhobart.de
Internet: www.ecomaxbyhobart.de

Hobart UK.

Southgate Way,
Orton Southgate,
Peterborough
PE2 6GN
United Kingdom
Tel.: +44 (0)844 888 7777
Republic of Ireland: +353 (0)1246 0248
Fax: +44 (0)1733 361 347
E-mail: sales@hobartuk.com
Internet: www.hobartuk.com

Compagnie HOBART SAS

Allée du 1er mai
77183 Croissy Beaubourg
FRANCE
Tel: +33 (0)1 64 11 60 00
Fax: +33 (0)1 64 11 60 10
E-mail: contact@hobart.fr
Internet: www.hobart.fr

Hobart Nederland BV

Pompmolenlaan 12
3447 GK Woerden
Telefoon +31 (0)348 462626
Fax: +31 (0)348 430117
E-mail: info@hobartnederland.nl
Internet: www.hobartnederland.nl

Hobart Foster Belgium bvba/sprl

Industriestraat 6
1910 Kampenhout
Telefoon +32 (0) 16.60.60.40
Fax +32 (0) 16.60.59.88
E-mail: info@hobart.be
Internet: www.hobart.be

Hobart Norge

Gamle Drammenvei 120
N-1363 Høvik
Tlf.: +47-67109800
E-post: post@hobart.no
Hjemmeside: www.hobart.no

Hobart Scandinavia ApS

Håndværkerbyen 27
2670 Greve
Danmark
Tlf.: +45 4390 5012
Fax.: +45 4390 5002
E-mail: salg@hobart.dk
Internet: www.hobart.dk

Hobart Sweden/Finland

Tel: +46 8 584 50 920
E-mail: info@hobart.se
Internet: www.hobart.se

Australia**Hobart Food Equipment**

Unit 1 / 2 Picken Street,
Silverwater NSW, 2128
Tel: +61 1800 462 278
Fax: +61 02 9714 0222
E-mail: sales@hobartfood.com.au
Internet: www.hobartequipment.com.au

HOBART China

15th Floor, Building A
New Caohejing International Business
Center
391 Gui Ping Road
Shanghai, 200233
Telephone: +86 (0)21 34612000
Fax: +86 (0)21 34617166
Internet: www.hobartchina.com