

HKN-DSH300, HKN-DSH350

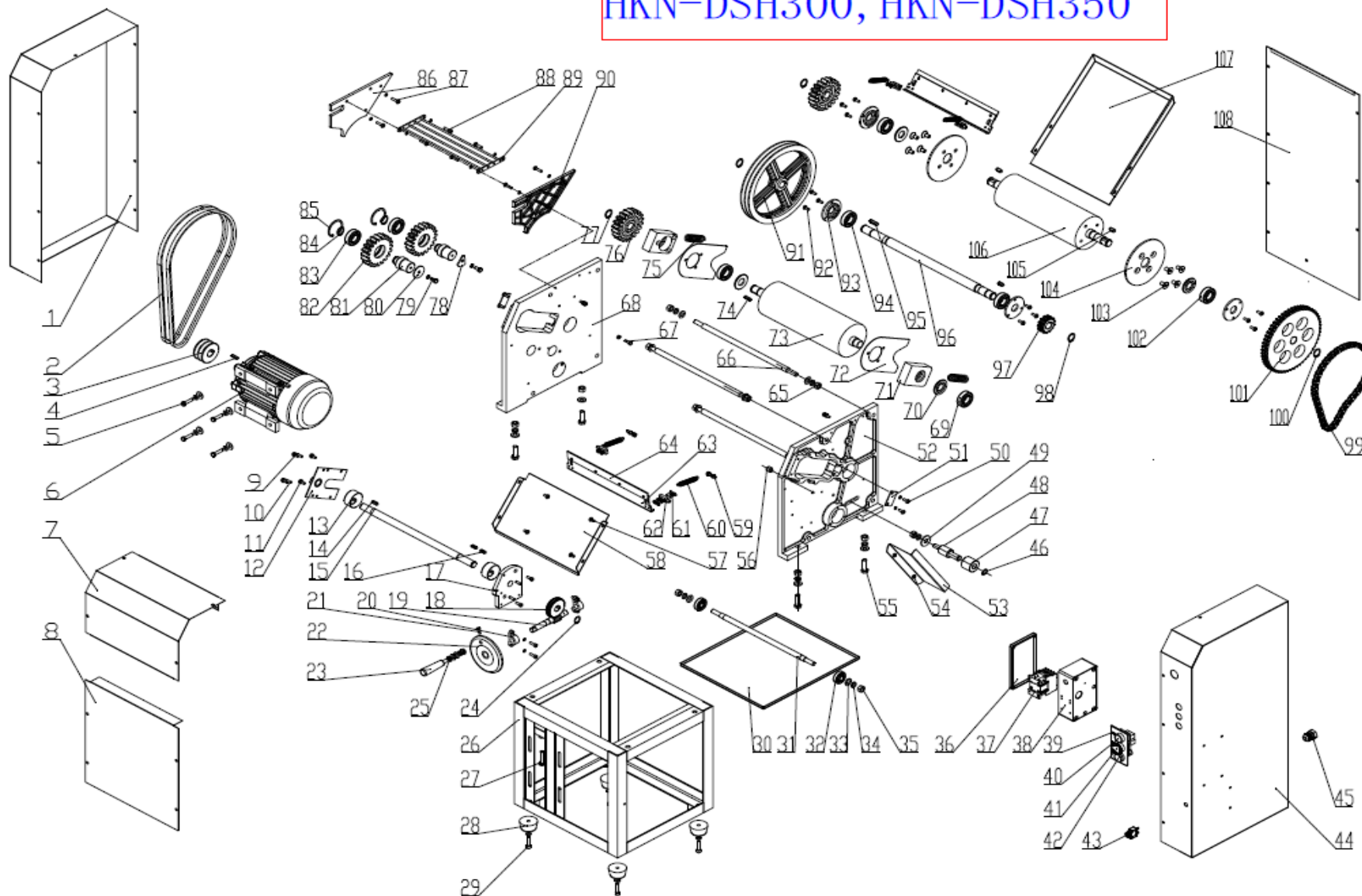

ТЕСТОРАСКАТКА HURAKAN HKN-DSH350

Поз	Наименование детали				
1	left cover	41	stop button	81	small bridge axis
2	v-belt	42	lamp	82	gear
3	motor pulley	43	overload protector	83	deep groove ball bearing
4	flat key	44	right cover	84	circlip for shaft
5	hexagon bolt	45	Power cord sheath	85	circlip for hole
6	motor	46	circlip for shaft	86	left blocking board
7	front cover	47	tension pulley	87	cross recess pan head screw
8	lower cover	48	tensioning shaft	88	cross recess pan head screw
9	hexagon bolt	49	large washer	89	protective grid
10	round pin	50	cross recess pan head screw	90	right blocking board
11	spring washer	51	compression spring damper	91	Passive pulley
12	Camshaft left bracket	52	right pannel	92	cross recess pan head screw
13	cam	53	oil weir	93	bearing cover
14	flat key	54	cross recess pan head screw	94	deep groove ball bearing
15	camshaft	55	hexagon bolt	95	flat key
16	flat key	56	fixed crew	96	bridge axis
17	Camshaft right bracket	57	cross recess pan head screw	97	drive sprocket
18	worn gear	58	Discharging plate	98	circlip for shaft
19	worn shaft	59	hexagon bolt	99	chain
20	worm seat	60	tension spring	100	circlip for shaft
21	hexagon bolt	61	cross recessed countersunk head screw	101	passive sprocket
22	handle wheel	62	support connector	102	deep groove ball bearing
23	handle shank	63	hanging panel seat	103	hexagon socket countersunk head screws
24	circlip for shaft	64	hanging panel	104	roll collar
25	hexagon thin nut	65	hex nut	105	flat key
26	rack	66	fixed rod	106	drive roll
27	hexagon bolt	67	hexagon bolt	107	feedboard
28	foot	68	left pannel	108	back cover
29	hexagon socket cap screws	69	deep groove ball bearing		
30	chassis	70	Dustproof inner ring of bearing		
31	fixed rod	71	sliding block		
32	clamping roller	72	slider baffle		
33	flat washer	73	passive roller		
34	spring washer	74	flat key		
35	hexagon thin nut	75	Sliding block compression spring		
36	electric box cover	76	transmission gear		
37	a.c contactor	77	circlip for shaft		
38	electric box	78	fan ring		
39	switch pannel	79	hexagon bolt		
40	start button	80	round collar		